

2022



Price Catalogue

HAKKIMIZDA

2010 yılında kurulan firmamız ISLAK HACİM EKİPMANLARI sektöründe üretim, toptan satış, proje çözümleri ve teknik servis konusunda hizmet vermektedir. Tüm bu hizmetlerin oluşumunda Noksi müşteri memnuniyeti ilkesiyle hareket eden profesyonel bir kuruluştur. NOKSİ bu ilke doğrultusunda hareket eden profesyonel bir kuruluştur.

Yurtiçinde edinmiş olduğu deneyim, gelişim ve kalite sayesinde dünyanın farklı birçok bölgesine üretmiş olduğu ürünleri ihracat etmektedir. İhracat alanında çalışmış olduğumuz bölgeler arasında Avrupa, Doğu Avrupa, Rusya, Ortadoğu, Balkanlar, Türk Cumhuriyetleri ve Kuzey Afrika öncelikli olarak sayılabilir.

Firmamız her özel projeye uygun ISO9001 belgeli marka tescilli üretim ve tasarım yapabilmektedir.

Hizmet verdiğimiz tüm ürün gruplarında garanti süresi ve satış sonrası teknik destek ile danışmanlık hizmetlerini hızlı bir şekilde yerine getirerek, müşteri memnuniyetini önemseyen ilkemize sadık kalmaktayız.

ABOUT US

NOKSI is a leading manufacturer of WASHROOM ACCESSORIES since 2010. NOKSI focuses to give service on design, production, project development and technical support. NOKSI is a professional establishment who has accepted the customer satisfaction as the main principle of the organization.

NOKSI is exporting to different parts of the world with the experience, knowledge and the quality that are gained in the domestic market. The regions that are exported to are: Europe, East Europe, Russia, Middle East, Balkan Countries, CIS Countries, and North Africa.

NOKSI has the expertise to design and develop new products that are suitable to ISO9001 for our esteemed partners.

NOKSI gives technical support and gurantee for the products. NOKSI continues to commit to provide products that meet market needs and environmental concerns.



Price Catalog Contents

Prestige	1
Tutunma Barları / Grab Bars	2
Duş Oturakları / Showers Seats	6
Hareketli Aynalar / Safety Mirrors	7
Kağıtlıklar / Paper Dispensers	8
Sıvı Sabunluklar / Soap Dispensers	10
Klozet Fırçaları / Toilet Brushes	12
Çöp Kovaları / Waste Bins	14
Renkli Serisi / Colored Series	21
Kombi Sistemleri / Combination Units	23
Küllükler / Ashtrays	25
Raf Havluluklar / Towel Racks	26
Valizlikler / Luggage Racks	28
Dış Mekan Çöp Kovaları / Outdoor Waste Bins	29
Geri Dönüşüm Çöp Kovaları / Recycle Bins	31
Paslanmaz Klozetler / Stainless Steel Toilets	33
Medikal Ekipmanlar / Medical Equipments	35
Sahil ve Havuz Duşları / Outdoor Shower Units	37
Duş Kanalları / Shower Drains	40
Yer Süzgeçleri / Floor Drains	44
Banyo Aksesuarları / Bathroom Accessories	46
Süngerlik Serisi / Sponge Holder Serie	74
Makyaj Aynaları / Make-up Mirrors	78
Ayaklı Setler / Freestand Sets	79
Ledli Aynalar / Illuminated Mirrors	68
Ayna Serisi / Mirror Series	69
Havlupan ve Vanalar / Towel and Valves	83
Fotoselli Ürünler / Photocell Products	84



Price Catalog

Descriptions

- 304K** AISI 304 Kalite Paslanmaz Çelik
AISI 304 Quality Stainless Steel
- 430K** AISI 430 Kalite Paslanmaz Çelik
AISI 430 Quality Stainless Steel
- PIRİNÇ** Pirinç Alaşım / Brass
- DKP** Karbon Çelik / Carbon Steel
- ABS** Plastik-Krom Kaplı / Plastic-Chrome Plated
- ALM** Alüminyum / Aluminum



Sıva Altı Kombi Sistemi

Recessed Combination Unit

304K • 250300

- 400 Kağıt Kapasiteli
Capacity 400 Z-Fold
- Kilit Tertibatlı / Secure Lock
- Dış Ölçüler / Outer Dimensions
HxWxD: 1162x328x90/206mm
- Montaj Ölçüleri / Mounting Dimensions
HxWxD: 1134x301x81,5mm
- Çöp Kovası Kapasitesi 25 LT
Dustbin Capacity 25 LT

PRICE
299,54



•250309 Sıva Üstü Kombi Sistemi

Non-Recessed Combination Unit

PRICE
329,50



Sıva Altı Kombi Sistemi

Recessed Combination Unit

304K • 250301

- Fotoselli Rulo Kağıt Verici
Photocell Operated Dispenser
- Pilli (4x1,5 V) ve Elektrikli
Battery and Electric Options
- Kilit Tertibatlı / Secure Lock
- Dış Ölçüler / Outer Dimensions
HxWxD: 1422x332x287mm
- Montaj Ölçüleri / Mounting Dimensions
HxWxD: 1383x293x92mm
- Çöp Kovası / Dustbin 15 LT

PRICE
691,14



•250310 Sıva Üstü Kombi Sistemi

Non-Recessed Combination Unit

PRICE
794,81



Sıva Altı Kombi Sistemi

Recessed Combination Unit

304K • 250311

- 400 Kağıt Kapasiteli
Capacity 400 Z-Fold
- Kilit Tertibatlı / Secure Lock
- Dış Ölçüler / Outer Dimensions
HxWxD: 1240x320x120/163mm
- Montaj Ölçüleri / Mounting Dimensions
HxWxD: 1200x280x112mm
- Çöp Kovası Kapasitesi 12 LT
Dustbin Capacity 12 LT

PRICE
322,01



•250312 Sıva Üstü Kombi Sistemi

Non-Recessed Combination Unit

PRICE
370,31



Klozet Kapak Örtücüsü

Toilet Seat Cover Paper Dispenser

304K • 250303

PRICE
66,75



Z Katlama Kağıt Havluluk

Z-Fold Towel Paper Dispenser

304K • 250302

- 400 Adetlik
- Kilit Tertibatlıdır
Secure Lock

PRICE
68,00



Sıva Üstü Kağıtlık

Toilet Roll Holder Non-recessed

304K • 250304 Tekli/Single

PRICE
29,21

• 250305 Çiftli/Double

37,46

- Kilit Tertibatlı/Secure Lock



Duvara Monte Klozet Fırçası

Wall Mounted Toilet Brush

304K • 250306

PRICE
33,31



Fotoselli Sıvı Sabunluk

Photocell Soap Dispenser

304K • 250307

- Kapasite: 1,2 Lt.

PRICE
420,74



Duvara Monte Çöp Kovası

Wall Mounted Dustbin

304K • 250308

- Kapasite: 15 Lt.

PRICE
128,68



Tutunma Barları

Safety Grab Bars



Tutunma Barı / Grab Bar Ø 19		PRICE	
304K •100300	11x20 cm	12,99	70
•101300	11x30 cm	13,49	50
•102300	11x40 cm	14,98	50
•103300	11x50 cm	15,98	30
•104300	11x60 cm	16,71	30



Tutunma Barı / Grab Bar Ø 20		PRICE	
Pirinç •923100	12x20 cm	25,56	70
•923200	12x30 cm	28,89	50
•923300	12x40 cm	32,22	50
•923400	12x50 cm	35,56	30

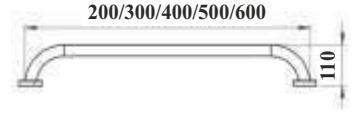

Tutunma Barı / Grab Bar Ø 25		PRICE	
304K •110300	11x20 cm	15,03	50
•111300	11x30 cm	16,58	30
•112300	11x40 cm	18,12	30
•113300	11x50 cm	19,69	20
•114300	11x60 cm	21,24	20



Tutunma Barı / Grab Bar Ø 32		PRICE	
304K •120300	11x30 cm	19,32	30
•121300	11x40 cm	21,63	30
•122300	11x50 cm	22,91	20
•123300	11x60 cm	24,95	20

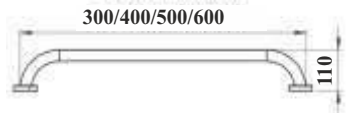

Tutunma Barı Beyaz / Grab Bar White Ø 32

DKP •499050	11x30 cm	16,43	30
•499051	11x40 cm	18,38	30
•499052	11x50 cm	19,47	20
•499053	11x60 cm	21,21	20



Tutunma Barı Grab Bar Easy Grip Ø 32		PRICE	
304K •020300	11x30 cm	21,64	30
•021300	11x40 cm	24,22	30
•022300	11x50 cm	25,66	20
•023300	11x60 cm	27,94	20

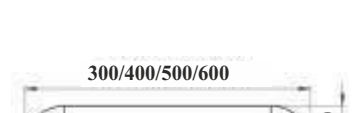

Tutunma Barı / Grab Bar Ø 35		PRICE	
304K •125300	11x30 cm	21,99	30
•126300	11x40 cm	24,78	30
•127300	11x50 cm	27,57	20
•128300	11x60 cm	30,37	20

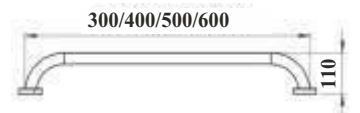

Tutunma Barı / Grab Bar Ø 38		PRICE	
304K •128301	11x30 cm	26,39	20
•128302	11x40 cm	29,74	20
•128303	11x50 cm	33,09	10
•128304	11x60 cm	36,44	10

Tutunma Barları

Safety Grab Bars



Açılı Tutunma Barı / Angled Grab Bar

PRICE



304K	•131300	Ø 19	22x22x8cm	16,10	30
	•130300	Ø 25	23x23x9cm	19,70	20
	•129300	Ø 32	32x32x11cm	25,05	12
Pirinç	•923500	Ø 20	22x22x12cm	34,44	20
Açılı Tutunma Barı Beyaz / Angled Grab Bar White					
DKP	•499058	Ø 32	32x32x11cm	21,29	20

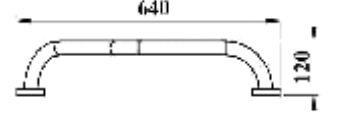

Açılı Süngerlikli Tutunma Barı Angled Grab Bar with Sponge Holder

PRICE



304K	•134300	Ø 19	22x22x11cm	20,45	20
	•133300	Ø 25	23x23x11cm	25,54	30
Pirinç	•923700	Ø 20	22x22x12cm	47,78	20

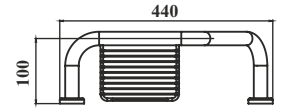

Açılı Süngerlikli Tutunma Barı Angled Grab Bar with Sponge Holder

PRICE



304K	•134300-1	Ø 19	22x22x11cm	20,45	20
	•133300-1	Ø 25	23x23x11cm	25,54	30

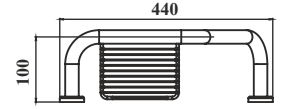

Mafsallı Tutunma Barı Ayaklı / Standing Fold-up Grab Bar

PRICE



304K	•135300	74,4x76x11 cm	114,45	4
DKP	•499082	74,4x76x11 cm	97,28	4

Mafsallı Tutunma Barı Ayaklı Kağıtlıklı / Standing Fold-up Grab Bar/With Roll Holder

304K	•135301	74,4x76x11 cm	117,24	4
DKP	•499096	74,4x76x11 cm	99,65	4

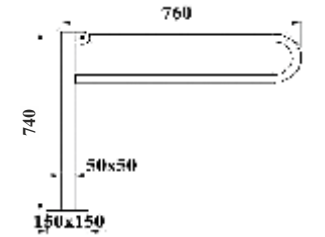

Tutunma Barı Üç Ayak Grab Bar Three Feet

PRICE



304K	•136300	60x21,5x16 cm	50,24	5
Tutunma Barı Üç Ayak Beyaz Grab Bar Three Feet White				
DKP	•499084	60x21,5x16 cm	42,71	5

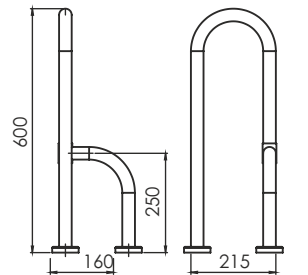

Tutunma Barı / Köşe Corner Grab Bar

PRICE



304K	•138300	80x40 cm	44,13	5
Tutunma Barı / Köşe Beyaz Corner Grab Bar White				
DKP	•499078	80x40 cm	37,51	5

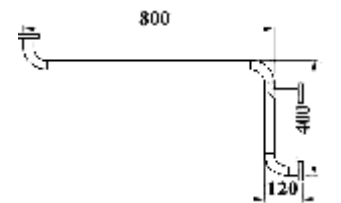

Tutunma Barları

Safety Grab Bars



Tutunma Bari Mafsalli
Kağıtlıklı / Destek Ayaklı
Fold-up Grab Bar with Roll Holder / Support Leg

PRICE

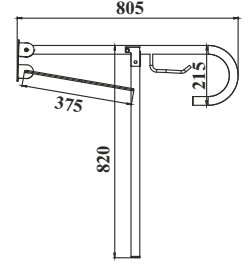

304K • 141310 82x80,5cm 95,16 10



Hareketli Tutunma Bari
Fold-up Grab Bar

PRICE

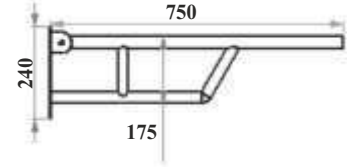

304K • 141317 75x24x11 cm 63,44 10



Sabit Tutunma Bari
Fixed Grab Bar

PRICE

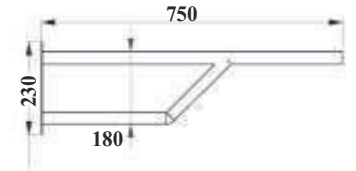

304K • 139307 75x23x11 cm 45,34 10



Tutunma Bari / Fixed Grab Bar

PRICE



304K • 139300 73x23,5x11cm 40,42 10

Tutunma Bari Beyaz / Fixed Grab Bar White

DKP • 499070 73x23,5x11cm 34,35 10

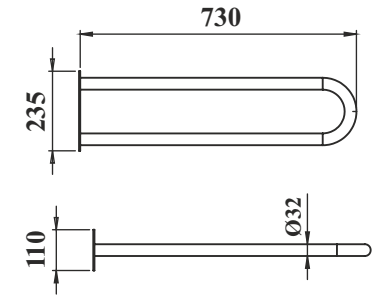

Tutunma Bari Mafsalli
Fold-up Grab Bar

PRICE



304K • 140300 73x23,5x11cm 49,05 10

Tutunma Bari Mafsalli Beyaz
Fold-up Grab Bar White

DKP • 499059 73x23,5x11cm 44,15 10

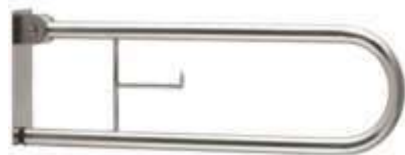
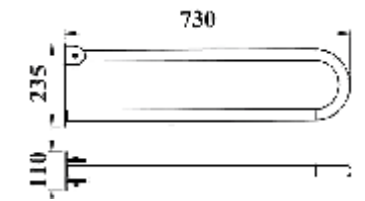

Tutunma Bari Mafsalli / Kağıtlıklı
Fold-up Grab Bar with Roll Holder

PRICE



304K • 141300 73x23,5x11cm 52,01 10

Tutunma Bari Mafsalli / Kağıtlıklı Beyaz
Fold-up Grab Bar with Roll Holder White

DKP • 499060 73x23,5x11cm 46,81 10

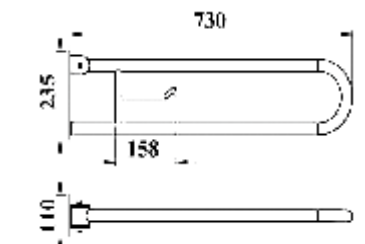

Tutunma Barları

Safety Grab Bars



Tutunma Barı Yerden-Duvara

Wall to Floor Grab Bar

304K • 142300 75x75 cm PRICE 34,11 13

Tutunma Barı Yerden-Duvara Beyaz

Wall to Floor Grab Bar White

DKP • 499061 75x75 cm PRICE 28,99 13

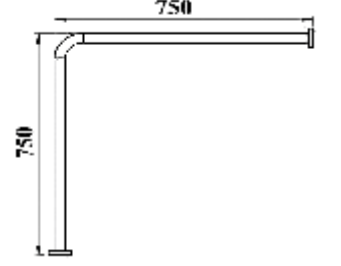

Tutunma Barı Yerden-Duvara Baston Ayak

Wall to Floor Grab Bar Cane Foot

304K • 143300 75x75cm Baston 30cm PRICE 46,23 13

Tutunma Barı Yerden-Duvara Döner Ayak

Wall to Floor Grab Bar Swivel Foot

304K • 144300 75x75cm Baston 30cm PRICE 48,55 13

Tutunma Barı Yerden-Duvara Baston Ayak Beyaz

Wall to Floor Grab Bar Cane Foot White

DKP • 499063 75x75cm Baston 30cm PRICE 39,30 13

Tutunma Barı Yerden-Duvara Döner Ayak Beyaz

Wall to Floor Grab Bar Swivel Foot White

DKP • 499083 75x75cm Baston 30cm PRICE 41,27 13

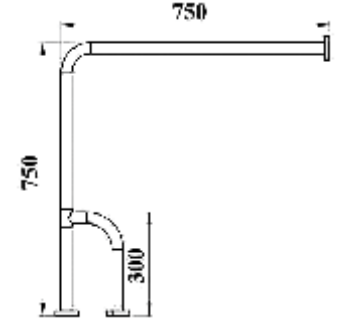

Tutunma Barı / L Tipi

L Shaped Grab Bar

304K • 145300 80x40x12cm PRICE 39,56 5

• 145307 80x40x12cm PRICE 39,56 5

Tutunma Barı / L Tipi Beyaz

L Shaped Grab Bar White

DKP • 499091 80x40x12cm PRICE 33,63 5

• 499091-1 80x40x12cm PRICE 33,63 5

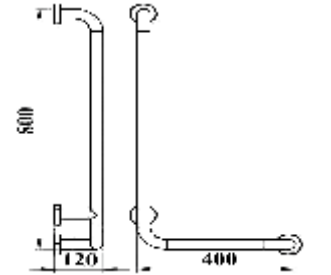

Engelli Lavabosu Bari

Disabled Sink Bar

304K • 146300 76x70x80cm PRICE 154,84 1

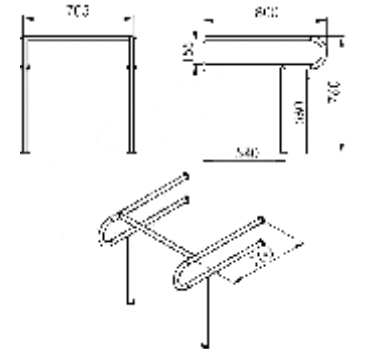

Duş Oturakları

Showers Seats



Katlanır Duş Oturağı / Ahşap

Fold-Up Shower Seat / Water Resistant Wood

PRICE



304K • 147311 40x39x39 cm 206,63 10

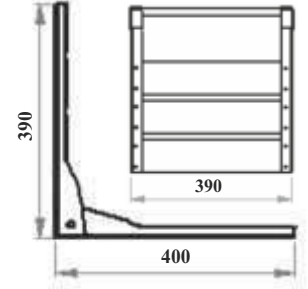

Duş Oturağı / Ahşap

Shower Seat Fold-Up / Wood

PRICE



304K • 147300 42x40x41 cm 78,39 10

Duş Oturağı / Kompozit

Shower Seat Fold-Up / Composite

304K • 147303 42x40x41 cm 121,50 10

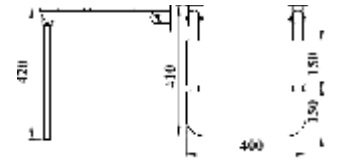

Duş Oturağı / Plastik

Shower Seat
Fold-Up / Plastic

PRICE



304K • 148300 45x40x43 cm 62,32 5

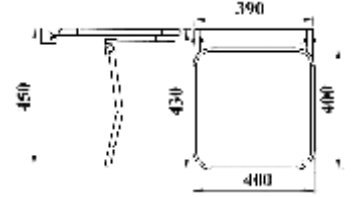

Duş Oturağı / Plastik

Shower Seat
Fold-Up / Plastic

PRICE



304K • 149300 45,5x44x42,5 cm 97,59 5

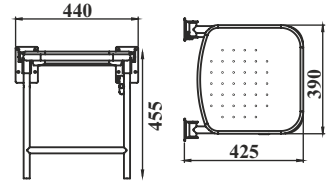

Duş Oturağı / Plastik

Shower Seat
Fold-Up / Plastic

PRICE



304K • 149301 45x40x14 cm 93,27 5

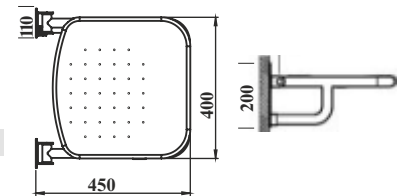

Duş Oturağı / Paslanmaz

Shower Seat
Fold-Up / Stainless Steel

PRICE



304K • 149302 46x44x10 cm 103,13 5
• 149302-1 46x44x10 cm 113,45

Destek Ayaklı/With Support Leg

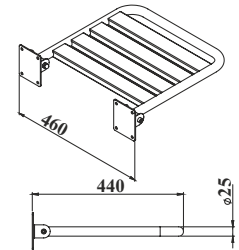

Duş Oturağı / Paslanmaz

Shower Seat
Fold-Up / Stainless Steel

PRICE



304K • 149305 46x44x10 cm 90,76 5

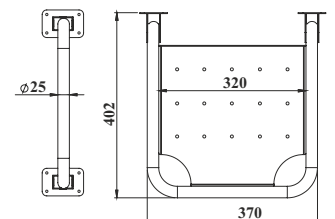

Hareketli Aynalar

Tilting Mirrors

noksi® safety

“ Daha güvenli ”

Special covering is applied on to the mirror to stop the mirror shattering around when it breaks.

Özel kaplamalı olan bu modelimiz kırıldığında dağılmaz.



PRICE



304K•150302 H: 70cm W: 50cm 77,28 5

360° Hareketli Ayna / Paslanmaz Çerçeve
360° Tilting Mirror / Stainless Steel Frame

PRICE



304K•150307 H: 70cm W: 50cm 88,21 4

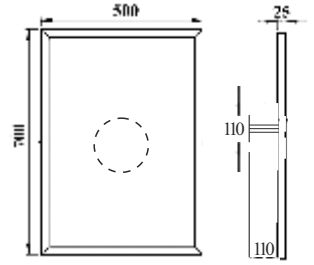

Buhar Tutmayan Hareketli Ayna
Steam Free Tilting Mirror

PRICE



304K•150344 H: 70cm W: 50cm 128,81 5

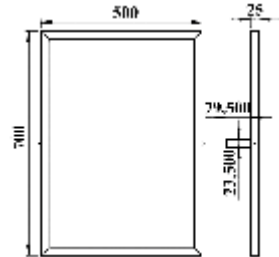

Hareketli Ayna
Tilting Mirror

PRICE



304K•150300 H: 70cm W: 50cm 64,40 5

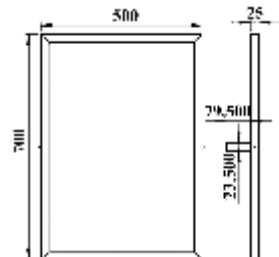

Hareketli Kulplu Ayna
Tilting Mirror with Handle

PRICE



304K•151300 H: 70cm W: 50cm 65,17 4

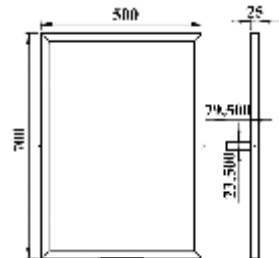

Kağıtlıklar

Paper Dispensers



Z Katlama Kağıt Havluluk

Z-Fold Towel Paper Dispenser

		PRICE	
304K	•200300 200 Adetlik 20,5x10x26 cm	30,88	14
	•201300 300 Adetlik 27x10x26 cm	36,56	12
	•202300 400 Adetlik 32,5x10x26 cm	43,76	9
430K	•203400 200 Adetlik 20,5x10x26 cm	22,16	14
	•204400 300 Adetlik 27x10x26 cm	27,56	12
	•205400 400 Adetlik 32,5x10x26 cm	29,14	9

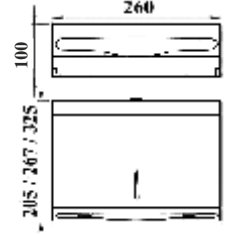

Jumbo WC Kağıt Verici

Jumbo Toilet Paper Dispenser

		PRICE	
304K	•254340 Ø 37,5cm W: 12cm	77,30	1
	•206300 Ø 27,5cm W: 12cm	40,15	8
	•206301 Ø 25cm W: 12cm	35,70	8
	•207300 (Mini) Ø 22cm W: 12cm	31,49	12
	•207301 (Mini) Ø 20cm W: 12cm	28,21	12
430K	•208400 Ø 27,5cm W: 12cm	29,88	8
	•208401 Ø 25cm W: 12cm	24,08	8
	•209400 (Mini) Ø 22cm W: 12cm	23,08	12
	•209401 (Mini) Ø 20cm W: 12cm	19,48	12

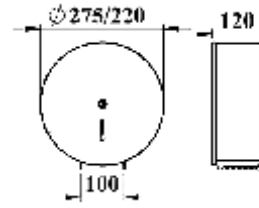

Cimri Kağıt Verici

Center Feed Paper Dispenser

		PRICE	
304K	•210300 Ø 20,5cm W: 13cm	38,70	12
	•210302 Ø 23cm W: 15cm	26,50	12

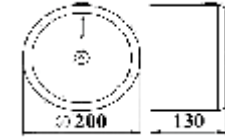

Klozet Kapak Örtücüsü

Toilet Seat Cover Paper Dispenser

		PRICE	
304K	•211300 27,5x5,3x39cm	16,40	15
430K	•212400 27,5x5,3x39cm	58,22	15

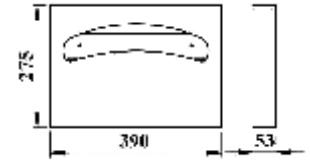

Klozet Kapak Örtücüsü / Sıva Altı Kilit Sistemi

Toilet Seat Cover Paper Dispenser Recessed / Locking System

		PRICE	
304K	•213300 45x32x4cm	58,22	5

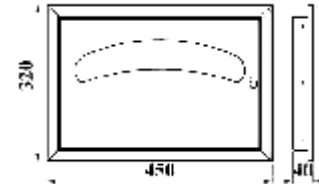

Sıva Üstü Kağıtlık

Toilet Roll Holder Non-recessed

		PRICE	
304K	•214300 16x16 cm Tekli/Single	22,11	30
	•216300 32x16 cm Çiftli/Double	41,02	15
430K	•215400 16x16 cm Tekli/Single	16,70,	30
	•217400 32x16 cm Çiftli/Double	29,68	15

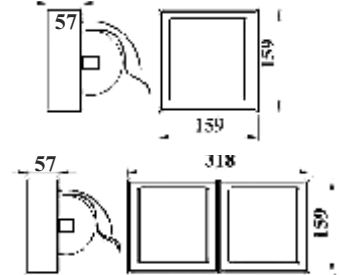

Sıva Altı Kağıtlık

Toilet Roll Holder Recessed

		PRICE	
304K	•218300 16x16 cm Tekli/Single	17,18	30
	•220300 32x16 cm Çiftli/Double	33,36	15
430K	•219400 16x16 cm Tekli/Single	13,21	30
	•221400 32x16 cm Çiftli/Double	20,34	15

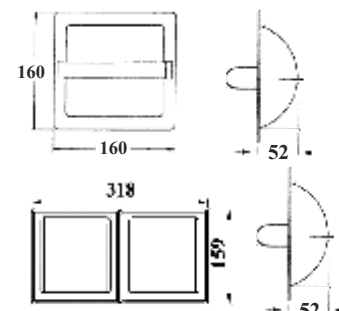

Kağıtlıklar

Paper Dispensers

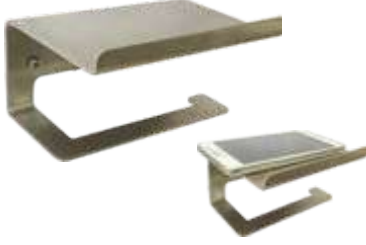

Çok Amaçlı Tuvalet Kağıtlık

Toilet Roll Holder With Mobile Phone Pad

PRICE



304K • 222305 12x13,7x6 cm 27,30 30

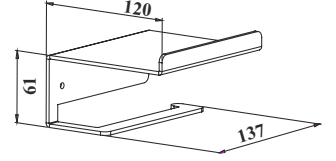

Çok Amaçlı Tuvalet Kağıtlık

Toilet Roll Holder With Mobile Phone Pad

PRICE



DKP • 222405 12x13,7x6 cm 12,67 30

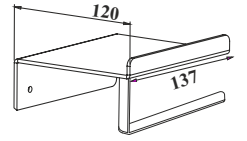

Tekli Kağıtlık / Toilet Roll Holder

304K • 222300 7x12,5x11,5cm 18,56 30

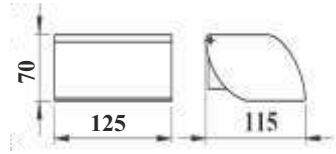

Tekli Kağıtlık / Kapaksız

Toilet Roll Holder / No Flap

PRICE

304K • 222301 9x14x4,5 cm 11,66 30

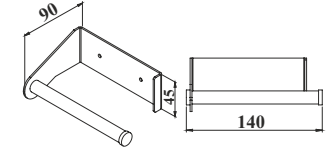

Tuvalet Kağıtlık

Toilet Roll Holder

PRICE



304K • 222308 13x7,5x2,5 cm 5,08 30

304K • 222306 12,5x11x8 cm 10,98 30

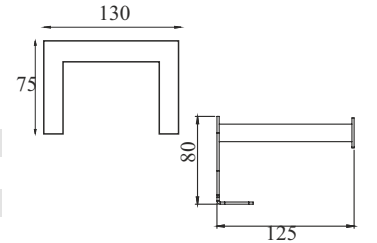

Kağıt Mendil Verici

Tissue Dispenser

PRICE



304K • 223300 12,6x23,5x6 cm 28,99 15

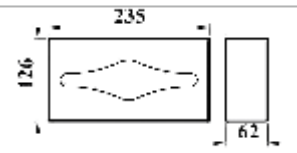

Kağıt Mendil Verici Oval

Tissue Dispenser

PRICE

304K • 224300 12,6x23,5x6,2 cm 28,99 15

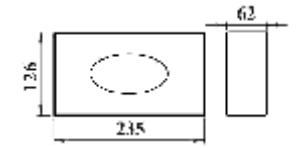

Kağıt Mendil Verici

Tissue Dispenser

PRICE



304K • 224301 13x13x13cm 33,65 15

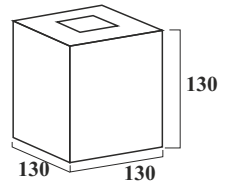

Hijyen Ped Poşet Kutusu

Hygienic Bag Dispenser

PRICE



304K • 225300 9x13x3,5 cm 15,96 15

• 225302 9,5x13,6x3,2 cm 17,56 15

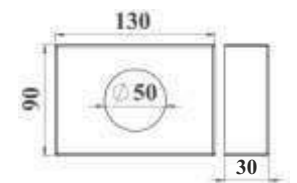

Sıvı Sabunluklar

Soap Dispensers



Sıvı Sabunluk		PRICE	
Liquid Soap Dispenser			
304K • 301300	500 ml 15,5x5,5x10cm	16,82	20
• 302300	1000 ml 22x6x13cm	21,97	20
Pirinç Pompa / Brass Pump			
304K • 302304	1000 ml 27x6x11cm	31,56	12

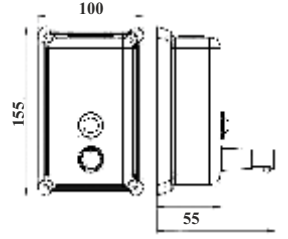

Yatay Sıvı Sabunluk / Soap Dispenser Horizontal		PRICE	
304K • 302302	1000 ml 27x6x11cm	33,11	12

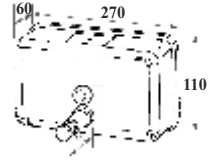

Köpük Verici / Foam Dispenser		PRICE	
304K • 302301	1000 ml 12x7x20cm	30,44	12

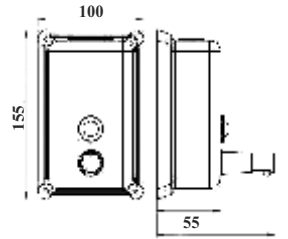

Ankastre Sıvı Sabunluk / 1Lt		PRICE	
Built-in Soap Dispenser 1Lt			
Pirinç • 309300	H: 45cm Ø 8,3cm	60,19	15
Ankastre Sıvı Sabunluk / 1Lt			
Built-in Soap Dispenser 1Lt			
Pirinç • 310300	H: 55cm Ø 8,3cm	64,81	15

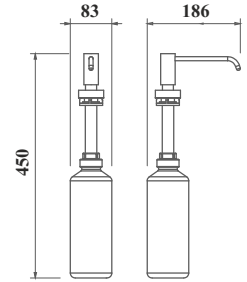

Ankastre Sıvı Sabunluk 1Lt		PRICE	
Built-in Soap Dispenser 1Lt			
Pirinç • 308300	H: 32,5cm Ø 8,5cm Pompa 14,5cm	9,75	25
Ankastre Köpük Verici 1Lt			
Built-in Foam Dispenser 1Lt			
Pirinç • 311300	H: 32,5cm Ø 8,5cm Pompa 12,5cm	46,88	15

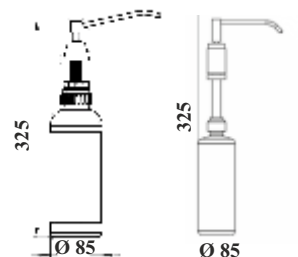

Sıvı Sabunluklar

Soap Dispensers



Sıvı Sabunluk / Soap Dispenser		PRICE	
304K • 302323	1000 ml 8,5x10x28,5cm	41,05	12
DKP • 302323-1	1000 ml 8,5x10x28,5cm Siyah/Black	36,67	12

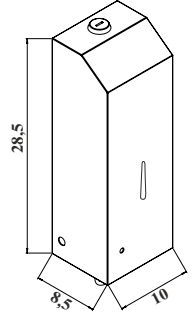

Set Üstü Sıvı Sabunluk		PRICE	
Countertop Soap Dispenser			
304K • 303300	H: 17,5cm Ø 7cm	11,56	20
• 304300	H: 17,5cm Ø 7cm (Askılı)	12,00	20

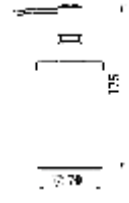

Küre Sıvı Sabunluk		PRICE	
Globe Soap Dispenser			
304K • 305300	H: 15cm Ø 9,6cm	11,39	20
Küre Sıvı Sabunluk / Cam			
Globe Soap Dispenser / Glass			
304K • 306300	H: 16cm Ø 10cm	9,00	30

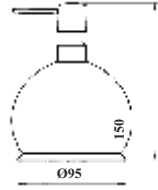

Set Üstü Sabunluk		PRICE	
Countertop Soap Holder			
ABS 303301	H: 14,5cm Ø 8cm	8,40	20
Set Üstü Diş Fırçalık			
Countertop Toothbrush Holder			
ABS • 307301	H: 5,5cm Ø 8cm	8,70	20

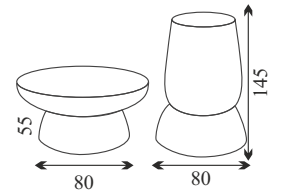

Dirsek Kumandalı Dezenfektan Verici		PRICE	
Elbow Operated Disinfectant Dispenser			
ALM 302324	31,7x9,4x9,2cm	29,81	20

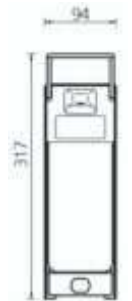

Klozet Fırçaları

Toilet Brushes



Klozet Fırçası / Lüks

Toilet Brush / Tube

304K • 895114 H: 38cm Ø 7,5

PRICE



31,10

20

Klozet Fırçası / Lüks Askılı

Toilet Brush / Tube / Wall Mounted

304K • 895114-2 H: 38cm Ø 7,5

34,21

20

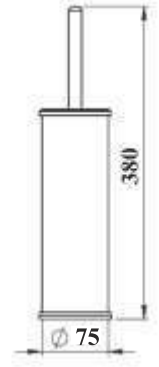

Klozet Fırçası / Mikro

Toilet Brush / Micro

304K • 402300 H: 36cm Ø 8,5

430K • 402400 H: 36cm Ø 8,5

PRICE



8,31

20

5,48

20

Klozet Fırçası / Mikro / Askılı

Toilet Brush / Micro / Wall Mounted

304K • 402301 H: 36cm Ø 8,5

430K • 402402 H: 36cm Ø 8,5

9,14

20

6,81

20

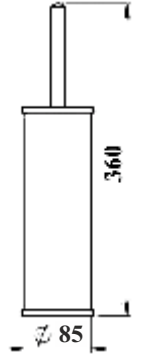

Klozet Fırçası Bombe Kapaklı Küçük Çap

Toilet Brush with Hinged Lid

304K • 351300 Küçük Çap H: 36cm Ø 8,5cm

430K • 352400 Küçük Çap H: 36cm Ø 8,5cm

PRICE



9,47

20

7,56

20

Klozet Fırçası Bombe Kapaklı / Askılı

Toilet Brush with Hinged Lid / Wall Mounted

304K • 351301 Küçük Çap H: 36cm Ø 8,5cm

430K • 352401 Küçük Çap H: 36cm Ø 8,5cm

10,26

20

8,35

20

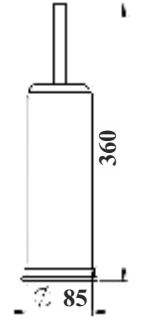

Klozet Fırçası Bombe Kapaklı Büyük Çap

Toilet Brush with Hinged Lid

304K • 355300 Büyük Çap H: 38cm Ø 9,5cm

430K • 355400 Büyük Çap H: 38cm Ø 9,5cm

PRICE



11,02

20

8,68

20

Klozet Fırçası Bombe Kapaklı / Askılı

Toilet Brush with Hinged Lid / Wall Mounted

304K • 355301 Büyük Çap H: 38cm Ø 9,5cm

430K • 355401 Büyük Çap H: 38cm Ø 9,5cm

11,79

20

9,41

20

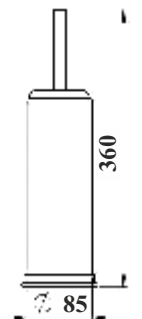

Klozet Fırçaları

Toilet Brushes



Klozet Fırçası / Düz Kapak

Toilet Brush Flat Lid

	PRICE	
304K • 365300 Büyük Çap H: 36cm Ø 9,5cm	9,97	20
430K • 366400 Büyük Çap H: 36cm Ø 9,5cm	6,96	20

Klozet Fırçası / Düz Kapak Askılı

Toilet Brush Flat Lid / Wall Mounted

304K • 367300 B.Çap Askılı H: 36cm Ø 9,5cm	10,97	20
430K • 368400 B.Çap Askılı H: 36cm Ø 9,5cm	8,08	20

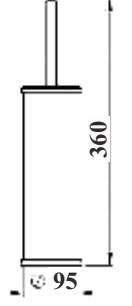

Klozet Fırçası Primit Kapak

Toilet Brush

	PRICE	
304K • 369302 H: 36cm Ø 8,5cm	10,30	20
• 369301 H: 36cm Ø 8,5cm Askılı	11,12	20

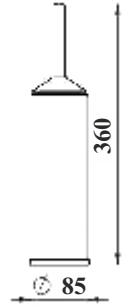

Klozet Fırçası / Biyeli

Toilet Brush

304K • 371300 Büyük Çap H: 38cm Ø 9,5cm	17,04	20
---	-------	----

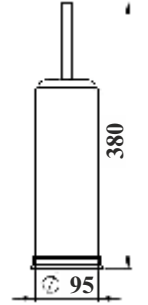

Duvara Monte Klozet Fırçası / Hareketli Kapak

Wall Mounted Toilet Brush / Adjustable Lid

304K • 372300 H: 34,5cm Ø 9cm	29,43	20
-------------------------------	-------	----

Duvara Monte Klozet Fırçası / Sabit Kapak

Wall Mounted Toilet Brush / Fixed Lid

304K • 372307 H: 34,5cm Ø 9cm	32,37	20
-------------------------------	-------	----

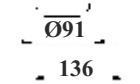
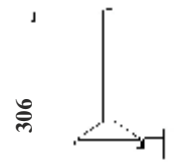

Klozet Fırçası / Kare

Luxury Toilet Brush Square

304K • 373300 H: 36x8x8cm	27,59	15
---------------------------	-------	----

Klozet Fırçası / Lüks Kare / Kaynaklı

Luxury Toilet Brush Square / Full Welded

304K • 373301 H: 36x8x8cm	33,11	15
---------------------------	-------	----

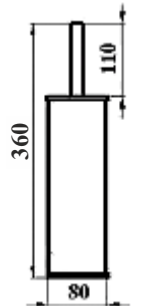

Çöp Kovaları

Dustbins



	Pedallı Çöp Kovası / Pedal Bin	PRICE	
430K • 000300	3 L H: 25cm Ø 17cm	11,39	8
• 000301	5 L H: 27cm Ø 20,5cm	16,80	8
• 000302	12 L H: 36cm Ø 25cm	24,67	8

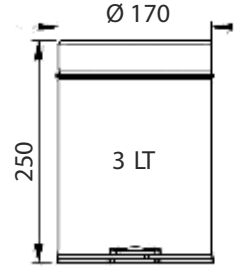

	Pedallı Çöp Kovası / Pedal Bin	PRICE	
430K • 000300-1	3 L H: 25cm Ø 17cm	14,06	8
• 000301-1	5 L H: 27cm Ø 20,5cm	18,94	8
• 000302-1	12 L H: 36cm Ø 25cm	28,04	8

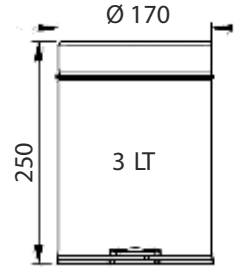

	Pedallı Çöp Kovası-Klozet Fırçası Seti Pedal Bin & Toilet Brush Set	PRICE	
430K • 000400	3 L H: 25cm Ø 17cm	19,47	8

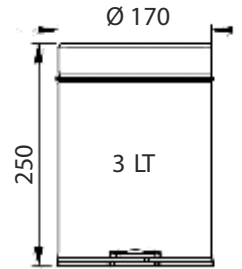

	Pedallı Çöp Kovası-Klozet Fırçası Seti Pedal Bin & Toilet Brush Set	PRICE	
430K • 000400-1	3 L H: 25cm Ø 17cm	22,63	8

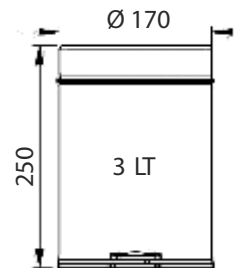

Renk Seçenekleri / Color Selections



Çöp Kovaları

Dustbins



Pratik Kapak Çöp Kovası

Easy Swing Dustbin

				PRICE	
430K	•495401	5 L H: 25cm Ø 21cm		21,43	8
	•495400	8 L H: 30,5cm Ø 20,5cm		22,37	8
	•496400	11 L H: 38cm Ø 20,5cm		25,07	6
	•497400	16 L H: 38cm Ø 24,5cm		31,63	6
	•498400	20 L H: 46,5cm Ø 24,5cm		35,14	6
	•499400	27 L H: 64,5cm Ø 24,5cm		38,65	6
	•500400	32 L H: 46,5cm Ø 31,5cm		46,85	4
	•501400	45 L H: 64,5cm Ø 31,5cm		51,54	4

Çemberli Çöp Kovası

Dustbin With Circle Lid

				PRICE	
430K	•502401	5 L H: 25cm Ø 21cm		18,51	8
	•502400	8 L H: 30,5cm Ø 20,5cm		19,56	8
	•503400	11 L H: 38cm Ø 20,5cm		22,14	6
	•504400	16 L H: 38cm Ø 24,5cm		27,64	6
	•505400	20 L H: 46,5cm Ø 24,5cm		32,68	6
	•506400	27 L H: 64,5cm Ø 24,5cm		35,14	6
	•507400	32 L H: 46,5cm Ø 31,5cm		41,46	4
	•508400	45 L H: 64,5cm Ø 31,5cm		45,68	4

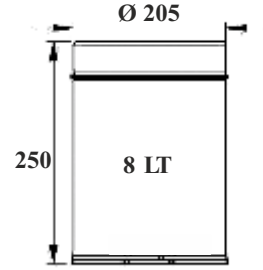

Yanmaz Çöp Kovası

Fireproof Dustbin

				PRICE	
430K	•576400	8 L H: 25cm Ø20,5cm		18,27	8
	•577400	13 L H: 33,5cm Ø20,5cm		21,43	6
	•578400	18 L H: 42cm Ø20,5cm		28,70	6

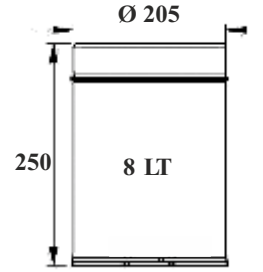

Paslanmaz Banyo Seti 4'lü

Stainless Steel Bathroom Set 4 pcs

			PRICE	
430K	•403400	3 L Çöp Kovası / 3 L Dustbin Mikro Klozet Fırçası / Toilet Brush Set Üstü Sabunluk / Countertop Soap Dispenser Dis Fırçalık / Toothbrush Holder	29,28	1

Diş Fırçalık

Toothbrush Holder

			PRICE	
	•307300	H: 11cm Ø 7cm	9,38	20



Paslanmaz Banyo Seti 2'li

Stainless Steel Bathroom Set 2 pcs

			PRICE	
430K	•404400	3 L Çöp Kovası / 3 L Dustbin Mikro Fırçalık / Micro Toilet Brush	20,03	1

Çöp Kovaları

Dustbins



Pedallı Çöp Kovası / Pedal Bin		PRICE	
304K	•365301 3 L Mikro H: 24cm Ø 16,5	18,64	8
	•405300 3 L H: 25cm Ø 18,5cm	20,49	8
	•406300 5 L H: 28cm Ø 20,5cm	24,53	8
	•407300 8 L H: 35,5cm Ø 20,5cm	29,04	6
	•408300 12 L H: 35,5cm Ø 24,5cm	34,98	6
430K	•400400 3 L Mikro H: 24cm Ø 16,5	10,42	8
	•409400 3 L H: 25cm Ø 18,5cm	12,65	8
	•410400 5 L H: 28cm Ø 20,5cm	15,34	8
	•411400 8 L H: 35,5cm Ø 20,5cm	18,62	6
	•412400 12 L H: 35,5cm Ø 24,5cm	22,49	6
	•413400 16 L H: 44,4cm Ø 24,5cm	28,11	4
	•414400 20 L H: 35,5cm Ø 31,5cm	37,48	4
	•415400 30 L H: 44,4cm Ø 31,5cm	42,64	4
	•416400 40 L H: 63cm Ø 31,5cm	53,88	4

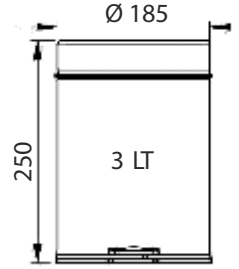

Pedallı Çöp Kovası / Yavaş Kapanır		PRICE	
Pedal Bin / Soft Close			
304K	•483300 3 L H: 24cm Ø 18,5cm	22,94	8
	•484300 5 L H: 26,5cm Ø 21cm	26,97	8
	•485300 8 L H: 35cm Ø 21cm	31,49	6
	•486300 12 L H: 35cm Ø 25cm	37,47	6
430K	•487400 3 L H: 24cm Ø 18,5cm	16,43	8
	•488400 5 L H: 26,5cm Ø 21cm	18,79	8
	•489400 8 L H: 35cm Ø 21cm	23,16	6
	•490400 12 L H: 35cm Ø 25cm	25,96	6
	•491400 16 L H: 43cm Ø 25cm	33,16	4
	•492400 20 L H: 35,5cm Ø 31,5cm	45,51	4
	•493400 30 L H: 44,5cm Ø 31,5cm	49,90	4
	•494400 40 L H: 62,5cm Ø 31,5cm	63,75	4

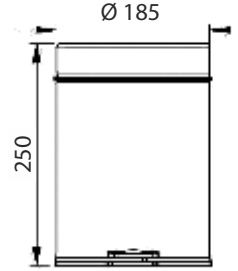

Kapaksız Çöp Kovası		PRICE	
Dustbin No Lid			
304K	•442300 3 L H: 23,5cm Ø 18,5cm	13,14	8
	•443300 5 L H: 26cm Ø 20,5cm	14,91	8
	•444300 8 L H: 33,5cm Ø 20,5cm	20,42	6
	•445300 12 L H: 33,5cm Ø 24,5cm	24,36	6
430K	•446400 3 L H: 23cm Ø 18,5cm	8,67	8
	•447400 5 L H: 26cm Ø 20,5cm	11,13	8
	•448400 8 L H: 33,5cm Ø 20,5cm	14,41	6
	•449400 12 L H: 33,5cm Ø 24,5cm	17,34	6
	•450400 16 L H: 41,5cm Ø 24,5cm	24,25	4
	•451400 20 L H: 34cm Ø 31,5cm	29,81	4
	•452400 30 L H: 41,5cm Ø 31,5cm	34,83	4
	•453400 40 L H: 60cm Ø 31,5cm	51,74	4

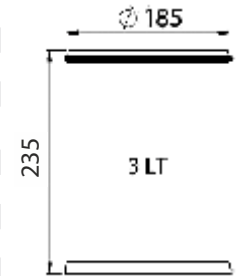

Çemberli Çöp Kovası		PRICE	
Dustbin with Round Lid			
304K	•462300 3 L H: 24cm Ø 19,5cm	20,51	8
	•463300 5 L H: 27cm Ø 21,5cm	23,91	8
	•464300 8 L H: 34,5cm Ø 20,5cm	29,65	6
	•465300 12 L H: 34,5cm Ø 24,5cm	36,12	6
430K	•466400 3 L H: 24cm Ø 19,5cm	12,18	8
	•467400 5 L H: 27cm Ø 21,5cm	15,34	8
	•468400 8 L H: 34,5cm Ø 20,5cm	18,51	6
	•469400 12 L H: 34,5cm Ø 24,5cm	22,37	6
	•470400 16 L H: 42,5cm Ø 24,5cm	29,17	4

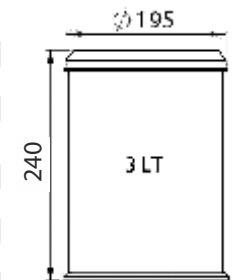

Çöp Kovaları

Dustbins



Endüstriyel Tip Pedallı Çöp Kovası

Industrial Type Pedal Bin with Wheels

430K	Model	Capacity	H	Ø	PRICE	Quantity
	•509401	40 L	40cm	Ø 41cm	132,04	1
	•509400	50 L	50cm	Ø 41cm	146,71	1
	•510400	70 L	63cm	Ø 41cm	156,50	1
	•511400	90 L	73cm	Ø 41cm	178,84	1

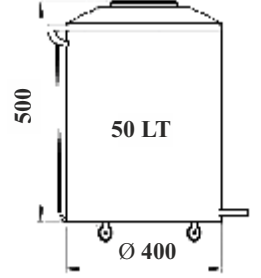

Kare Endüstriyel Pedallı Çöp Kovası

Camber Lid Dustbin

DKP	Model	Capacity	Dimensions	PRICE	Quantity
	•512400	40 L	50x30x30cm	111,72	1
	•513400	50 L	60x30x30cm	132,67	1
	•514400	70 L	65x35x35cm	150,67	1
	•515400	90 L	80x35x35cm	262,53	1
	•516400	120 L	80x40x40cm	288,00	1

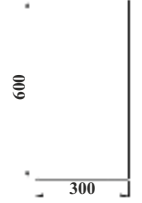

Bombe Kapaklı Çöp Kovası

Camber Lid Dustbin

430K	Model	H	Ø	PRICE	Quantity
	•572400	67cm	Ø 30cm	75,33	4
	•573400	78cm	Ø 35cm (Battal Boy)	103,60	4

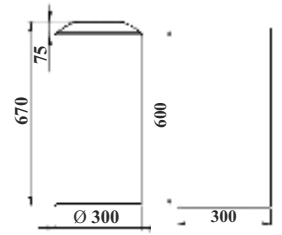

Düz Kapaklı Çöp Kovası

Plain Lid Dustbin

430K	Model	H	Ø	PRICE	Quantity
	•574400	60cm	Ø 30cm	96,00	4
	•575400	70cm	Ø 35cm (Battal Boy)	185,87	4



DKP Boyalı Ofis Tipi Çöp Kovası

Painted Office Type Dustbin

Model	Capacity	H	Ø	PRICE	Quantity
•479401	12L	26cm	Ø 26cm	8,32	30

DKP Boyalı Ofis Tipi Çöp Kovası / Delikli

Painted Office Type Dustbin / Holes

Model	Capacity	H	Ø	PRICE	Quantity
•480401	12L	26cm	Ø 26cm	8,94	30

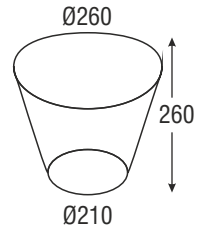

DKP Boyalı Ofis Tipi Çöp Kovası

Painted Office Type Dustbin

Model	Capacity	H	Ø	PRICE	Quantity
•481401	12L	26cm	Ø 26cm	8,32	30

DKP Boyalı Ofis Tipi Çöp Kovası / Delikli

Painted Office Type Dustbin / Holes

Model	Capacity	H	Ø	PRICE	Quantity
•482401	12L	26cm	Ø 26cm	8,94	30

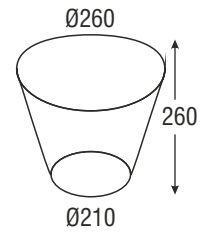

Ofis Tipi Çöp Kovası / Fileli

Office Type Dustbin / Mesh

Model	Capacity	H	Ø	PRICE	Quantity
•479420	12L	28cm	Ø 24cm	7,71	30

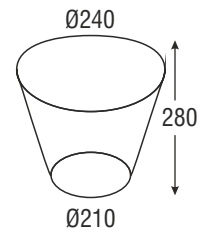

Çöp Kovaları

Dustbins



	Sallanır Kapak Çöp Kovası Swinging Lid Dustbin	PRICE	
304K	•532300 7 L W: 15x17cm H: 28,5cm	38,53	1
	•533300 11 L W: 18x20cm H: 39cm	60,29	1
	•534300 16 L W: 18x20cm H: 50cm	63,31	1
	•535300 25 L W: 24x28cm H: 48cm	90,87	1
	•536300 36 L W: 24x28cm H: 63,5cm	118,66	1
	•537300 45 L W: 30x35cm H: 55,5cm	143,14	1
	•538300 54 L W: 30x35cm H: 61,5cm	153,96	1
	•539300 80 L W: 30x35cm H: 89,5cm	225,98	1
430K	•540400 7 L W: 15x17cm H: 28,5cm	26,96	1
	•541400 11 L W: 18x20cm H: 39cm	39,51	1
	•542400 16 L W: 18x20cm H: 50cm	42,28	1
	•543400 25 L W: 24x28cm H: 48cm	59,74	1
	•544400 36 L W: 24x28cm H: 63,5cm	77,06	1
	•545400 45 L W: 30x35cm H: 55,5cm	92,38	1
	•546400 54 L W: 30x35cm H: 61,5cm	99,30	1
	•547400 80 L W: 30x35cm H: 89,5cm	144,32	1

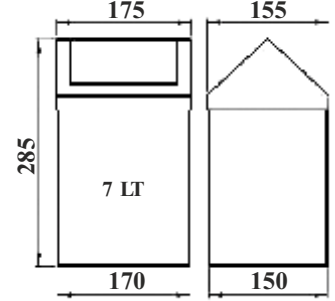

	Yaylı Kapak Çöp Kovası Spring-loaded Lid Dustbin	PRICE	
304K	•548300 7 L 14x20,5x33,5cm	48,41	1
	•549300 11 L 15,5x24,5x43cm	57,58	1
430K	•550400 7 L 14x20,5x33,5cm	31,35	1
	•551400 11 L 15,5x24,5x43cm	39,30	1

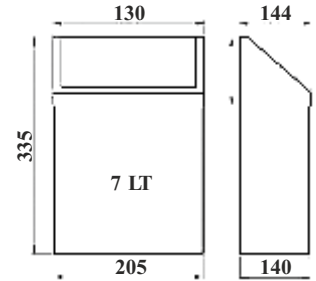

	Açık Çatı Kapak Çöp Kovası Open Cover Dustbin	PRICE	
304K	•552300 7 L 14x20,5x33,5cm	42,35	1
	•553300 11 L 15,5x24,5x43cm	51,48	1
	•554300 25 L 24x28x48,5cm	81,25	1
	•555300 36 L 24x28x64,5cm	98,80	1
	•556300 45 L 30x35x55,5cm	134,43	1
430K	•557400 7 L 14x20,5x33,5cm	28,48	1
	•558400 11 L 15,5x24,5x43cm	34,19	1
	•559400 25 L 24x28x48,5cm	53,12	1
	•560400 36 L 24x28x64,5cm	64,09	1
	•561400 45 L 30x35x55,5cm	86,36	1

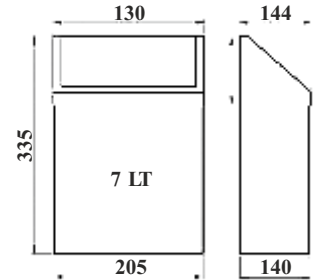

	Açık Çatı Kapak Çöp Kovası / Askılı Open Cover Dustbin / Wall Mounted	PRICE	
304K	•562300 7 L 14x20,5x33,5cm	44,41	1
	•563300 11 L 15,5x24,5x43cm	53,76	1
	•564300 25 L 24x28x48,5cm	84,28	1
	•565300 36 L 24x28x64,5cm	101,83	1
	•566300 45 L 30x35x55,5cm	138,13	1
430K	•567400 7 L 14x20,5x33,5cm	30,49	1
	•568400 11 L 15,5x24,5x43cm	36,33	1
	•569400 25 L 24x28x48,5cm	55,41	1
	•570400 36 L 24x28x64,5cm	66,38	1
	•571400 45 L 30x35x55,5cm	89,06	1

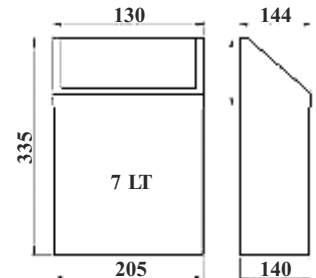

Çöp Kovaları

Dustbins



Duvara Montajlı Çöp Kovası

Wall Mounted Dustbin

		PRICE	
304K	•512300 6 L 10x25x25cm	27,76	1
	•513300 11 L 12x25x36cm	36,48	1
	•514300 16 L 12x33x40cm	47,60	1
	•515300 25 L 15,5x35,8x43,5cm	57,64	1
	•516300 28 L 18x35x44cm	67,66	1
430K	•517400 6 L 10x25x25cm	17,17	1
	•518400 11 L 12x25x36cm	24,07	1
	•519400 16 L 12x33x40cm	31,02	1
	•520400 25 L 15,5x35,8x43,5cm	36,20	1
	•521400 28 L 18x35x44cm	40,30	1

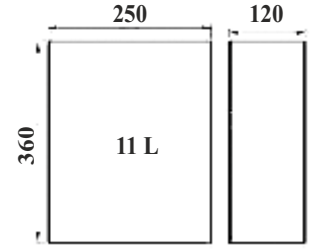

Duvara Montajlı Çöp Kovası / Kapaklı

Wall Mounted Dustbin with Lid

		PRICE	
304K	•522300 6 L 10x25x25cm	31,89	1
	•523300 11 L 12x25x36cm	37,96	1
	•524300 16 L 12x33x40cm	55,93	1
	•525300 25 L 15,5x35,8x43,5cm	62,77	1
	•526300 28 L 18x35x44cm	63,93	1
430K	•527400 6 L 10x25x25cm	21,77	1
	•528400 11 L 12x25x36cm	28,67	1
	•529400 16 L 12x33x40cm	37,47	1
	•530400 25 L 15,5x35,8x43,5cm	41,00	1
	•531400 28 L 18x35x44cm	48,73	1

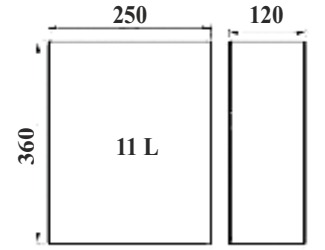

Duvara Montajlı Hijyen Ped Kutulu Çöp Kovası / Kapaklı

Wall Mounted Dustbin with Lid
And Hygienic Bag Dispenser

		PRICE	
304K	•525301 25 L 15,5x35,8x43,5cm	63,35	1

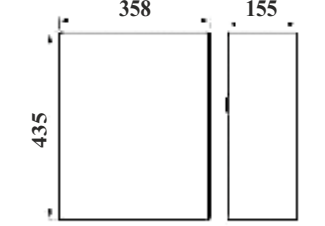

D Tipi Çöp Kovası / D-Shape D Dustbin

		PRICE	
304K	•579300 12L H: 40cm Ø27,5cm	54,34	1
430K	•580400 12L H: 40cm Ø27,5cm	35,11	1

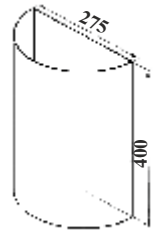

Masaüstü Çöp Kovası

Counter-Top Dustbin

		PRICE	
430K	•581400 1.5 L H: 18,5 cm Ø 12,5 cm	8,97	12

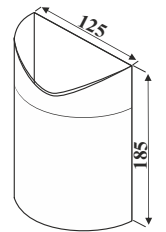

Dolap İçi Çöp Kovası

Inside Cabinet Dustbin

		PRICE	
430K	•751400 11 L H: 28,5cm Ø 25	14,44	12

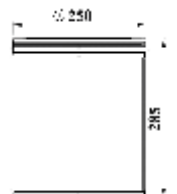

Çöp Kovaları

Dustbins



Atom Pedalı Çöp Kovası

Pedal Bin 5 Lt.

430K • 410490 5 L H: 34cm Ø 20,5cm

PRICE



28,01 8

Atom Klozet Fırçası

Toilet Brush

430K • 410491 H: 39,5cm Ø 9,5cm

PRICE



10,80 20

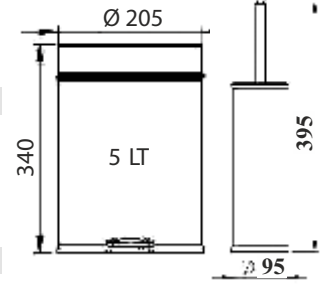

Boyalı Pratik Kapak Çöp Kovası

Painted Easy Swing Dustbin

430K • 495400-1 8 L H: 30,5cm Ø 20,5cm
• 499400-1 27 L H: 64,5cm Ø 24,5cm
• 501400-1 45 L H: 64,5cm Ø 31,5cm

PRICE



31,14 8
50,62 8
69,64 6

Boyalı Çemberli Çöp Kovası

Painted Dustbin With Circle Lid

430K • 502400-1 8 L H: 30,5cm Ø 20,5cm
• 506400-1 27 L H: 64,5cm Ø 24,5cm
• 508400-1 45 L H: 64,5cm Ø 31,5cm

PRICE



25,43 8
45,63 8
65,84 6

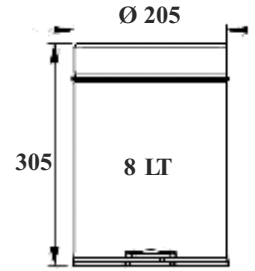

Kolon Küllük / Dustbin Ashtray

FİYAT / PRICE



430K • 762400-1 1 nolu 20L H: 60cm Ø 19cm ₺ 516,97 8
• 763400-1 2 nolu 25L H: 60cm Ø 21cm ₺ 563,28 8
• 764400-1 3 nolu 30L H: 60cm Ø 25cm ₺ 709,47 6
• 765400-1 4 nolu 35L H: 60cm Ø 28cm ₺ 837,80 4

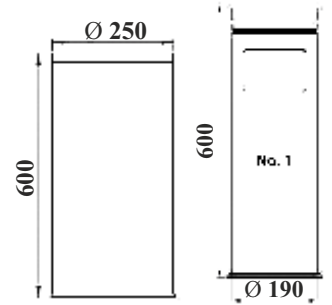

Şampanya Küllük

Champagne Ashtray

430K • 767400-1 H: 65cm Ø 31cm

PRICE



46,11 4

Lobi Küllük / Lobby Ashtray

430K • 768400-1 H: 71cm Ø 26cm

PRICE



42,06 4

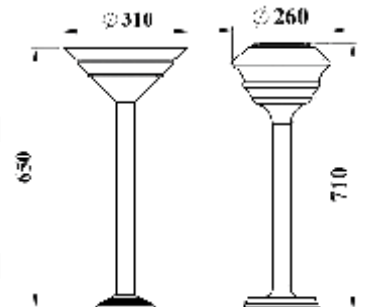

Renk Seçenekleri / Color Selections



Renkli Serisi

Colored Series



PRICE
31,59
32,90
39,39

Z Katlama Kağıt Havluluk
Z-Fold Towel Paper Dispenser

- 203490 200'lük 20,5x10x26 cm
- 204490 300'lük 27x10x26 cm
- 205490 400'lük 32,5x10x26 cm



PRICE
36,14
32,13
28,34
25,39

Jumbo WC Kağıt Verici
Jumbo Toilet Paper Dispenser

- 208490 Ø 27,5cm W: 12cm
- 208490-1 Ø 25cm W: 12cm
- 209490 (Mini) Ø 22cm W: 12cm
- 209490-1 (Mini) Ø 20cm W: 12cm



Klozet Kapak Örtücüsü
Toilet Seat Cover Paper Dispenser

PRICE
23,85



Kağıt Mendil Verici
Tissue Dispenser

•223490

PRICE
26,09



Sıvı Sabunluk 1 Lt.
Liquid Soap Dispenser

•302490

PRICE
26,36



Sıvı Sabunluk
Soap Dispenser

- 303390 Tezgah Üstü 13,87
- 304390 Askılı 14,40

PRICE



Diş Fırçalık
Toothbrush Brush

•307390

PRICE
10,44



Klozet Fırçası / Kare
Luxury Toilet Brush Square

•373317

PRICE
20,14



Sallanır Kapak Çöp Kovası
Swinging Lid Dustbin

- | | PRICE |
|----------------|--------------|
| •540490 7 Lt. | 32,35 |
| •541490 11 Lt. | 47,41 |
| •543490 25 Lt. | 71,69 |
| •545490 45 Lt. | 110,86 |
| •547490 80 Lt. | 173,18 |

Renk Seçenekleri / Color Selections



Boyalı Çöp Kovaları Boyalı Klozet Fırçaları Colored Dustbins & Toilet Brushes



Pedallı Çöp Kovası / Siyah - Pedal Bin / Black Klozet Fırçası / Siyah - Toilet Brush / Black

			PRICE	
430K	•409401	3 L H: 25cm Ø 18,5cm	11,98	8
	•410401	5 L H: 28cm Ø 20,5cm	14,42	8
	•412401	12 L H: 35,5cm Ø 24,5cm	17,48	6
	•402401	Fırça/Brush H: 36cm Ø 8,5cm	7,33	20

•588400 5Lt Çöp Kovası ve Fırça Seti
5Lt Pedal Bin & Toilet Brush Set 25,30

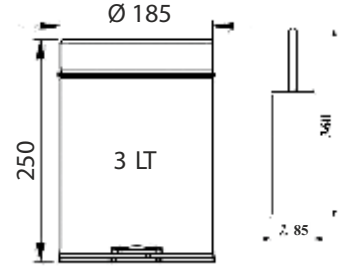

Pedallı Çöp Kovası / Beyaz - Pedal Bin / White Klozet Fırçası / Beyaz - Toilet Brush / White

			PRICE	
430K	•409402	3 L H: 25cm Ø 18,5cm	11,98	8
	•410402	5 L H: 28cm Ø 20,5cm	14,42	8
	•412402	12 L H: 35,5cm Ø 24,5cm	17,48	6
	•402402-1	Fırça/Brush H: 36cm Ø 8,5cm	7,33	20

•587400 5Lt Çöp Kovası ve Fırça Seti
5Lt Pedal Bin & Toilet Brush Set 25,30

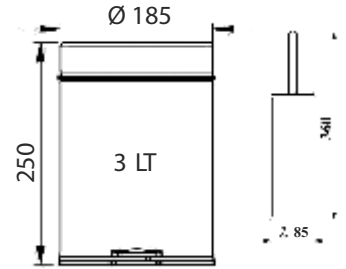

Pedallı Çöp Kovası / Gri - Pedal Bin / Gray Klozet Fırçası / Gri - Toilet Brush / Gray

			PRICE	
430K	•409403	3 L H: 25cm Ø 18,5cm	11,98	8
	•410403	5 L H: 28cm Ø 20,5cm	14,42	8
	•412403	12 L H: 35,5cm Ø 24,5cm	17,48	6
	•402403	Fırça/Brush H: 36cm Ø 8,5cm	7,33	20

•583400 5Lt Çöp Kovası ve Fırça Seti
5Lt Pedal Bin & Toilet Brush Set 25,30

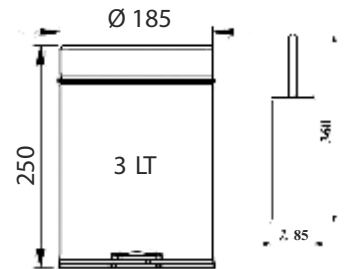

Pedallı Çöp Kovası / Kırmızı - Pedal Bin / Red Klozet Fırçası / Kırmızı - Toilet Brush / Red

			PRICE	
430K	•409404	3 L H: 25cm Ø 18,5cm	11,98	8
	•410404	5 L H: 28cm Ø 20,5cm	14,42	8
	•412404	12 L H: 35,5cm Ø 24,5cm	17,48	6
	•402404	Fırça/Brush H: 36cm Ø 8,5cm	7,33	20

•585400 5Lt Çöp Kovası ve Fırça Seti
5Lt Pedal Bin & Toilet Brush Set 25,30

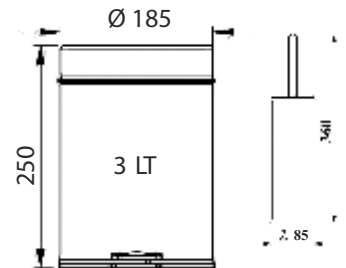

Pedallı Çöp Kovası / Turuncu - Pedal Bin / Orange Klozet Fırçası / Turuncu - Toilet Brush / Orange

			PRICE	
430K	•409405	3 L H: 25cm Ø 18,5cm	11,98	8
	•410405	5 L H: 28cm Ø 20,5cm	14,42	8
	•412405	12 L H: 35,5cm Ø 24,5cm	17,48	6
	•402405	Fırça/Brush H: 36cm Ø 8,5cm	7,33	20

•584400 5Lt Çöp Kovası ve Fırça Seti
5Lt Pedal Bin & Toilet Brush Set 25,30

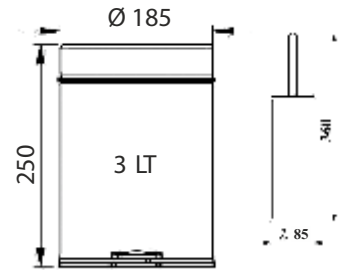

Pedallı Çöp Kovası / Pembe - Pedal Bin / Pink Klozet Fırçası / Pembe - Toilet Brush / Pink

			PRICE	
430K	•409406	3 L H: 25cm Ø 18,5cm	11,98	8
	•410406	5 L H: 28cm Ø 20,5cm	14,42	8
	•412406	12 L H: 35,5cm Ø 24,5cm	17,48	6
	•402406	Fırça/Brush H: 36cm Ø 8,5cm	7,33	20

•586400 5Lt Çöp Kovası ve Fırça Seti
5Lt Pedal Bin & Toilet Brush Set 25,30

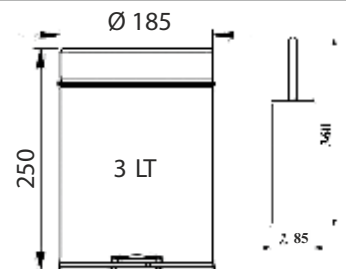

Kombi Sistemleri

Combination Units



Oval Çöp Kovalı Kombi

Combination Unit with
D-Shape Dustbin

	PRICE
304K • 226300 105x26x10cm	156,87
430K • 227400 105x26x10cm	104,78

Çöp Kovası Kapasitesi 9 LT
Dustbin Capacity 9 LT



Düz Çöp Kovalı Kombi

Combination Unit with
Rectangular Dustbin

	PRICE
304K • 228300 105x26x10cm	156,87
430K • 229400 105x26x10cm	104,78

Çöp Kovası Kapasitesi 9 LT
Dustbin Capacity 9 LT



Sıva Altı Kombi Sistemi

Recessed Combination Unit

	PRICE
304K • 230300	367,27

- 400 Kağıt Kapasiteli
Capacity 400 Z-Fold
- Kilit Tertibatlı / Secure Lock
- Dış Ölçüler / Outer Dimensions
HxWxD: 1250x350x160mm
- Montaj Ölçüleri / Mounting Dimensions
HxWxD: 1212x312x152mm
- Çöp Kovası Kapasitesi 25 LT
Dustbin Capacity 25 LT



Sıva Altı Kombi Sistemi

Recessed Combination Unit

	PRICE
304K • 231300	720,46

- 400 Kağıt Kapasiteli
Capacity 400 Z-Fold
- El Kurutmalı / Hand Dryer
- Kilit Tertibatlı / Secure Lock
- Dış Ölçüler / Outer Dimensions
HxWxD: 1650x370x160mm
- Montaj Ölçüleri / Mounting Dimensions
HxWxD: 1610x330x150mm
- Çöp Kovası Kapasitesi 23 LT
Dustbin Capacity 23 LT



Sıva Altı Kombi Sistemi

Recessed Combination Unit

	PRICE
304K • 232300	681,63

- Fotoselli Rulo Kağıt Verici
Photocell Operated Dispenser
- Pili (4x1,5 V) ve Elektrikli
Battery and Electric Options
- Kilit Tertibatlı / Secure Lock
- Dış Ölçüler / Outer Dimensions
HxWxD: 1300x332x152mm
- Montaj Ölçüleri / Mounting Dimensions
HxWxD: 1262x294x144mm
- Çöp Kovası / Dustbin 15 LT



Sıva Üstü Kombi Sistemi

Non-Recessed Combination Unit

304K • 232301	749,79
---------------	--------



Sıva Altı Kombi Sistemi

Recessed Combination Unit

	PRICE
304K • 232300-1	579,39

- Fotoselli Rulo Kağıt Verici
Photocell Operated Dispenser
- Pili (4x1,5 V) ve Elektrikli
Battery and Electric Options
- Kilit Tertibatlı / Secure Lock
- Dış Ölçüler / Outer Dimensions
HxWxD: 1300x320x130mm
- Montaj Ölçüleri / Mounting Dimensions
HxWxD: 1260x283x120mm
- Çöp Kovası / Dustbin 15 LT



Sıva Üstü Kombi Sistemi

Non-Recessed Combination Unit

304K • 232301-1	637,32
-----------------	--------

- HxWxD: 1300x320x140mm

Kombi Sistemleri

Combination Units



Sıva Altı Kombi
Recessed Combination Unit

304K • 235300

PRICE
299,51

- 300-400 Kağıt Kapasiteli
Capacity 300-400 Z-Fold
- Kilit Tertibatlı / Secure Lock
- Dış Ölçüler / Outer Dimensions
HxWxD: 1100x330x125mm
- Montaj Ölçüleri / Mounting Dimensions
HxWxD: 1062x292x117mm
- Çöp Kovası Kapasitesi 9 LT
Dustbin Capacity 9 LT



1

Sıva Üstü Kapaklı Kombi
Non-recessed Combination Unit

304K • 234300

PRICE
329,46



Sıva Altı Kombi Sistemi
Recessed Combination Unit

304K • 233300

PRICE
440,73

- 400 Kağıt Kapasiteli
Capacity 400 Z-Fold
- Kilit Tertibatlı / Secure Lock
- Dış Ölçüler / Outer Dimensions
HxWxD: 1400x330x130mm
- Montaj Ölçüleri / Mounting Dimensions
HxWxD: 1360x290x112mm



1



Z Katlama Kağıt Havluluk / Sıva Altı
Z-Fold Paper Towel Dispenser/Recessed

304K • 237300

PRICE
305,23

- 600-800 Kağıt Kapasiteli
Capacity 600-800 Z-Fold
- Kilit Tertibatlı / Secure Lock
- Dış Ölçüler / Outer Dimensions
HxWxD: 360x710x120mm
- Montaj Ölçüleri / Mounting Dimensions
HxWxD: 325x670x110mm



1



Sıva Altı Kombi Sistemi
Recessed Combination Unit

304K • 239300

PRICE
238,83

- 200-300 Kağıt Kapasiteli
Capacity 200-300 Z-Fold
- Kilit Tertibatlı / Secure Lock
- Dış Ölçüler / Outer Dimensions
HxWxD: 710x350x120mm
- Montaj Ölçüleri / Mounting Dimensions
HxWxD: 670x312x112mm
- Çöp Kovası Kapasitesi 9 LT
Dustbin Capacity 9 LT



1

Sıva Üstü Kombi Sistemi
Non-Recessed Combination Unit

304K • 239301

PRICE
135,11



Z Katlama Kağıt Havluluk / Sıva Altı
Z-Fold Paper Towel Dispenser/Recessed

304K • 202301

PRICE
135,11

- 300-400 Kağıt Kapasiteli
Capacity 300-400 Z-Fold
- Kilit Tertibatlı / Secure Lock
- Dış Ölçüler / Outer Dimensions
HxWxD: 468x316x103mm
- Montaj Ölçüleri / Mounting Dimensions
HxWxD: 431x275x94mm



1



Sıva Altı Çöp Kovası
Recessed Combination Unit

304K • 238300

PRICE
305,23

- Çöp Kovası Kapasitesi 47 LT
Dustbin Capacity 47 LT
- Kilit Tertibatlı / Secure Lock
- Dış Ölçüler / Outer Dimensions
HxWxD: 440x770x210mm
- Montaj Ölçüleri / Mounting Dimensions
HxWxD: 400x730x110mm



1



Fotoselli Kağıt Havlu Makinası
Paper Towel Machine with Photocell

304K • 240300

PRICE
420,73

- Pili (4x1,5 V) ve Elektrikli
Battery and Electric Options
- Uzunluk Ayarlı Mekanizma
Length Adjustable
- Ölçüler / Dimensions
HxWxD: 390x290x225mm
- Kağıt Boyu/Paper Size 210mm



1



Fotoselli Kağıt Havlu Makinası
Paper Towel Machine with Photocell

304K • 240300-1

PRICE
357,62

- Pili (4x1,5 V) ve Elektrikli
Battery and Electric Options
- Uzunluk Ayarlı Mekanizma
Length Adjustable
- Ölçüler / Dimensions
HxWxD: 310x290x220mm
- Kağıt Boyu/Paper Size 210mm



1

Küllükler

Ashtrays



İzmaritlik Ashtray

DKP • **767401** 95x32 cm

PRICE

117,13



1

Kare İzmaritlik Square Ashtray

DKP • **767402** 80x25 cm

PRICE

124,26



1

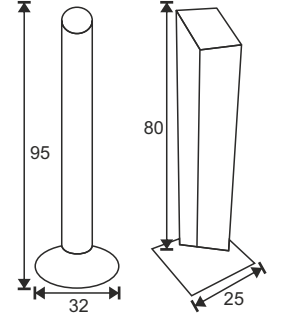

762400

761400



İzgaralı Kolon Küllük Grid Dustbin Ashtray

430K • **761400** H: 60cm Ø 25cm

PRICE

50,12



6

Kolon Küllük / Dustbin Ashtray

430K • **762400** 1 nolu 20L H: 60cm Ø 19cm 35,41 8
 • **763400** 2 nolu 25L H: 60cm Ø 21cm 38,50 8
 • **764400** 3 nolu 30L H: 60cm Ø 25cm 47,53 6
 • **765400** 4 nolu 35L H: 60cm Ø 28cm 57,04 4

PRICE

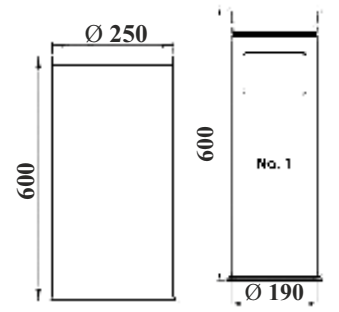

Kare Kolon Küllük Dustbin Square Ashtray

304K • **766300** 60L 80x28x28cm

PRICE

114,07



1

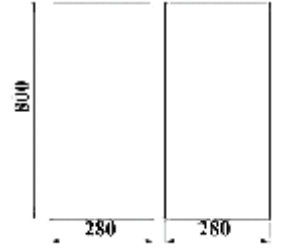

Kare Kolon Küllük Dustbin Square Ashtray

304K • **766301** 30L 23x23x60 cm

PRICE

131,19



1

430K • **766400** 30L 23x23x60 cm

96,96

1

DKP • **766401** 30L 23x23x60 cm

65,59

1

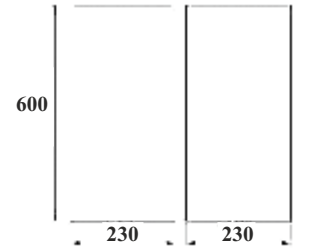

Şampanya Küllük Champagne Ashtray

430K • **767400** H: 65cm Ø 31cm

PRICE

43,49



4

Lobi Küllük / Lobby Ashtray

430K • **768400** H: 71cm Ø 26cm

43,97

4

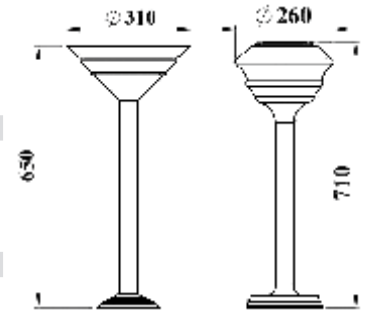

Raf Havluluklar

Towel Racks



Raf Havluluk
Towel Rack

PRICE

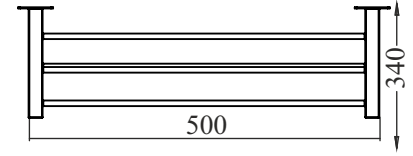

304K • 782300-1 50x34x19 cm

36,08

1



Raf Havluluk
Towel Rack

PRICE

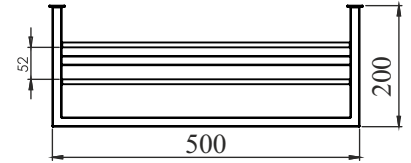

304K • 789300 50x20x17 cm

70,58

1



Raf Havluluk
Towel Rack

PRICE

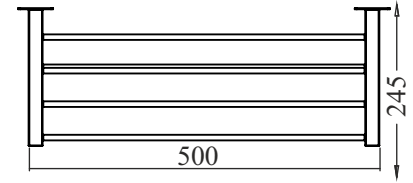

304K • 789301 50x24.5x12 cm

51,65

1



Raf Havluluk
Towel Rack

PRICE

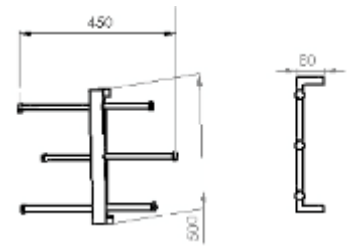

304K • 789302 50x45x8 cm

71,75

1



Çamaşır İpi
Clothline

PRICE

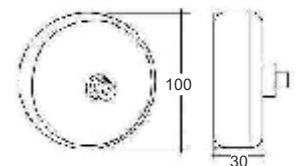

304K • 809300 10x3 cm

12,86

20

Raf Havluluklar

Towel Racks



Lamalı Raf Havluluk
Towel Rack

PRICE



304K • **781300** 16x30x51cm
Pirinç • **918300** 19x28x45cm

38,57

20

65,78

20

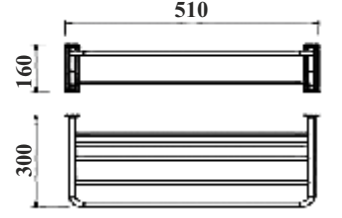

Raf Havluluk / Towel Rack

PRICE



304K • **782300** 11x20x50cm

35,29

20

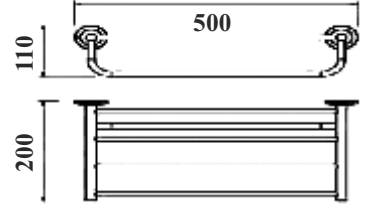

Lamalı Raf Havluluk
Towel Rack

PRICE



304K • **782301** 16x30x51cm

35,83

20

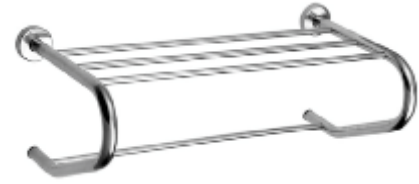
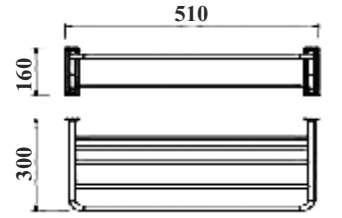

Destekli Raf Havluluk
Towel Rack

PRICE



304K • **783300** 19x27x50cm
Pirinç • **918100** 20x30x45cm

41,95

20

96,67

20

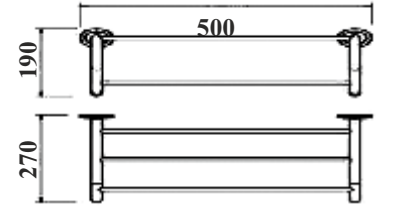

Destekli Raf Havluluk
Towel Rack

PRICE



304K • **784300** 16x31x50cm

41,33

20

Pirinç • **918350** 14,5x30x45cm

96,67

20

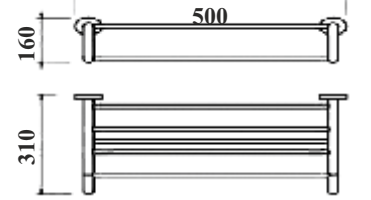

Kızaklı Raf Havluluk
Towel Rack Sliding

PRICE



304K • **785301** 22x52cm

33,51

20

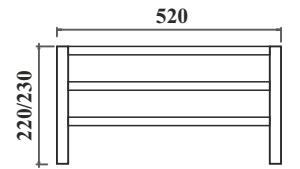

Körüklü Raf Havluluk
Towel Rack

PRICE



304K • **785300** 11x13x50 cm

70,50

10

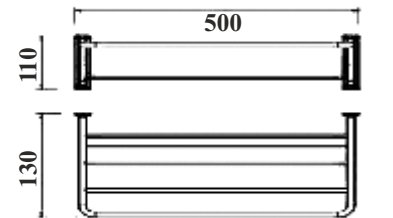

Döner Havluluk
Towel Rail Swivel

PRICE



304K • **786300** 16x42cm Dörtlü / Quartet

42,46

20

• **787300** 13x42cm Üçlü / Triple

33,06

20

• **788300** 10x42cm İkilili / Double

25,55

20

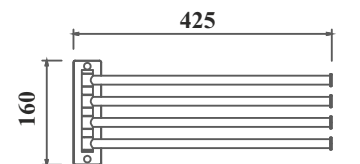

Valizlikler

Luggage Racks



Valizlik / Luggage Rack

PRICE



304K	•801300-1	74,5x50cm	181,50	1
				1

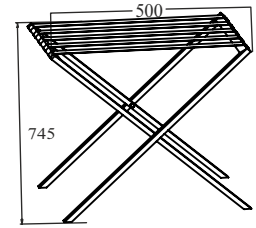

Valizlik / Luggage Rack

PRICE



304K	•801300	54x49x56cm Ø19	65,50	1
DKP	•801301	54x49x56cm Ø19	46,13	1

Lüks Valizlik / Luxury Luggage Rack

304K	•801302	54x49x56cm Ø25	92,22	1
DKP	•801303	54x49x56cm Ø25	50,60	1

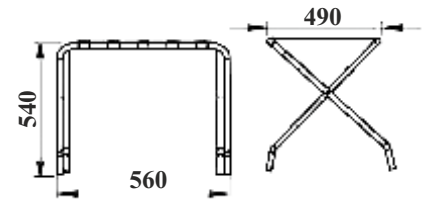

Valizlik / Destekli

Luggage Rack with
Back Support

PRICE



304K	•802300	68x49x56cm Ø19	76,67	1
DKP	•802301	68x49x56cm Ø19	47,50	1

Lüks Valizlik / Destekli

Luxury Luggage Rack with Back Support

304K	•802302	68x49x56cm Ø25	110,86	1
DKP	•802303	68x49x56cm Ø25	53,37	1

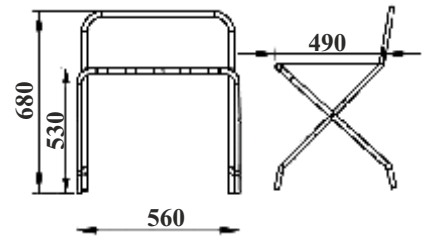

Ahşap Valizlik

Luggage Rack / Wood

PRICE



304K	•803300	68x49x56cm	76,56	1
------	---------	------------	-------	---

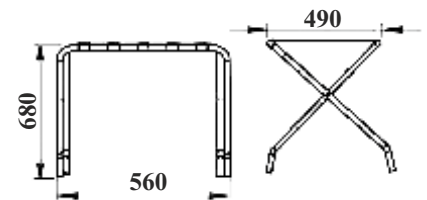

Ahşap Valizlik / Destekli

Luggage Rack with Back
Support

PRICE



304K	•804300	68x49x56cm	81,66	1
------	---------	------------	-------	---

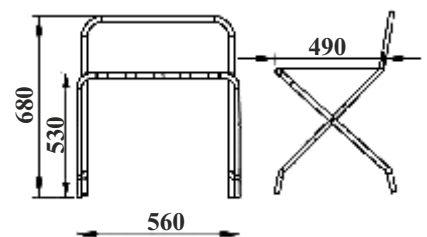

Dış Mekan Çöp Kovaları Outdoor Dustbins



Ahşap Çöp Kovası / Silindir 35 Lt.
Wooden Dustbin / Cylinder 35 Lt.

PRICE



•815400 30x50cm / 35x65cm 161,07 1

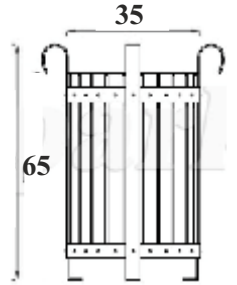

Ahşap Çöp Kovası / Kare 40 Lt.
Wooden Dustbin Square 40 Lt.



•815401 30x30x50cm / 35x35x65cm 182,13 1

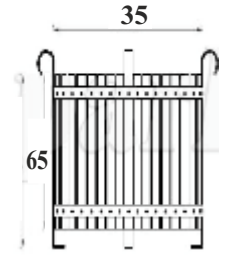

Bahçe Çöp Kovası 35 Lt.
Garden Dustbin 35 Lt.

PRICE



304K •813300 30x50cm / 48x48x115cm 197,59 1
DKP •813400 30x50cm / 48x48x115cm 58,06 1

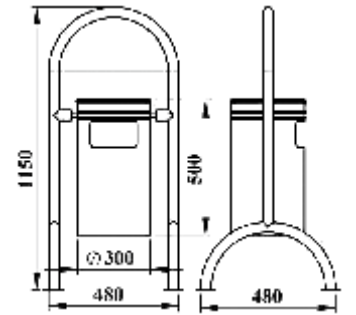

Bahçe Çöp Kovası 35 Lt.
Garden Dustbin 35 Lt.

PRICE



304K •812300 30x50cm / 48x115cm 197,59 1
DKP •812400 30x50cm / 48x115cm 52,25 1

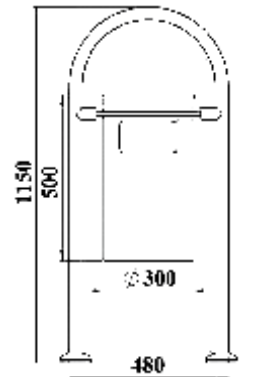

Dış Mekan Çöp Kovaları Outdoor Dustbins



Bahçe Çöp Kovası 35 Lt.

Garden Dustbin 35 Lt.

		PRICE	
304K	•810300 30x50cm / 42x47x75cm	177,83	1
DKP	•810400 30x50cm / 42x47x75cm	54,19	1

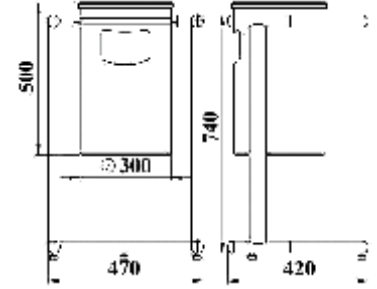

Bahçe Çöp Kovası 35 Lt.

Garden Dustbin 35 Lt.

		PRICE	
304K	•817300 30x50cm / 48x80cm	195,62	1
DKP	•817400 30x50cm / 48x80cm	59,60	1

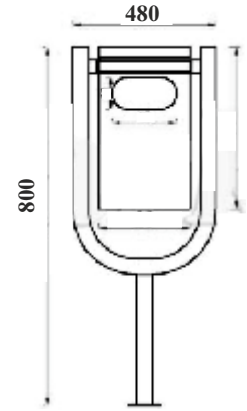

Bahçe Çöp Kovası 35 Lt.

Garden Dustbin 35 Lt.

		PRICE	
304K	•811300 30x50cm / 45x80cm	177,02	1
DKP	•811400 30x50cm / 45x80cm	46,85	1

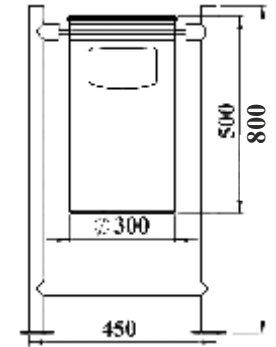

Bahçe Çöp Kovası 35 Lt.

Garden Dustbin 35 Lt.

		PRICE	
304K	•816300 30x50cm / 45x110cm	195,62	1
DKP	•816400 30x50cm / 45x110cm	54,19	1

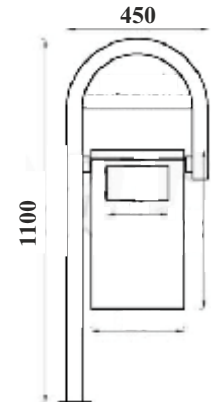

Gerİ Dönüşüm Çöp Kovaları Recycle Bins



Gerİ Dönüşüm Kovaları Silindır Kasalı Recycle Bins With Case

					PRICE	
304K	•818300	30x60 / 35x65x65	İkili/Double	80 Lt.	254,40	1
	•818301	30x60 / 35x95x65	Üçlü/Triple	120 Lt.	381,60	1
	•818302	30x60 / 35x125x65	Dörtlü/Quartet	160 Lt.	508,80	1
DKP	•818400	30x60 / 35x65x65	İkili/Double	80 Lt.	150,40	1
	•818401	30x60 / 35x95x65	Üçlü/Triple	120 Lt.	225,60	1
	•818402	30x60 / 35x125x65	Dörtlü/Quartet	160 Lt.	300,80	1

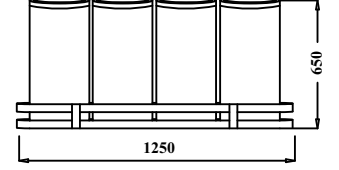

Gerİ Dönüşüm Kovaları Recycle Bins

					PRICE	
304K	•818303	30x60	İkili/Double	80 Lt.	201,07	1
	•818304	30x60	Üçlü/Triple	120 Lt.	301,60	1
	•818305	30x60	Dörtlü /Quartet	160 Lt.	402,13	1
DKP	•818403	30x60	İkili/Double	80 Lt.	97,07	1
	•818404	30x60	Üçlü/Triple	120 Lt.	145,60	1
	•818405	30x60	Dörtlü /Quartet	160 Lt.	194,13	1

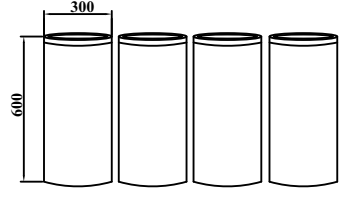

Gerİ Dönüşüm Kovaları Recycle Bins

					PRICE	
430K	•818446	26x52x70	İkili/Double	54 Lt.	262,13	1
	•818447	26x76x70	Üçlü/Triple	81 Lt.	385,87	1
	•818448	26x105x70	Dörtlü /Quartet	108 Lt.	508,27	1
430K	•818449	34x66x70	İkili/Double	90 Lt.	327,67	1
	•818450	34x100x70	Üçlü/Triple	135 Lt.	482,33	1
	•818451	34x132x70	Dörtlü /Quartet	180 Lt.	635,33	1

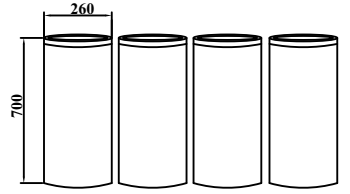

Gerİ Dönüşüm Kovaları Recycle Bins

					PRICE	
304K	•818315	40 Lx2/30x60x60	İkili/Double	80 Lt.	812,93	1
	•818316	40 Lx3/30x90x60	Üçlü/Triple	120 Lt.	1.072,53	1
	•818317	40 Lx4/30x120x60	Dörtlü/Quartet	160 Lt.	1.430,40	1
DKP	•818418	40 Lx2/30x60x60	İkili/Double	80 Lt.	496,53	1
	•818419	40 Lx3/30x90x60	Üçlü/Triple	120 Lt.	744,93	1
	•818420	40 Lx4/30x120x60	Dörtlü/Quartet	160 Lt.	992,00	1

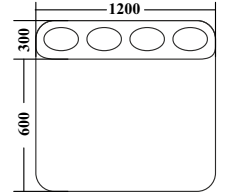

Gerİ Dönüşüm Kovaları Recycle Bins

					PRICE	
304K	•818318	40 Lx2/32x64x80	İkili/Double	80 Lt.	812,93	1
	•818319	40 Lx3/32x96x80	Üçlü/Triple	120 Lt.	1.072,53	1
	•818320	40 Lx4/32x128x80	Dörtlü/Quartet	160 Lt.	1.430,40	1
DKP	•818421	40 Lx2/32x64x80	İkili/Double	80 Lt.	496,53	1
	•818422	40 Lx3/32x96x80	Üçlü/Triple	120 Lt.	744,93	1
	•818423	40 Lx4/32x128x80	Dörtlü/Quartet	160 Lt.	992,00	1

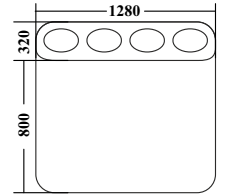

Gerİ Dönüşüm Kovaları Yarım Ağız Recycle Bins Open Cover Lid

					PRICE	
430K	•818415	30x55x19	Üçlü / Triple	30 Lt.	137,50	1
	•818416	60x70x23	Üçlü / Triple	90 Lt.	333,46	1
	•818417	60x90x30	Üçlü / Triple	160 Lt.	387,65	1

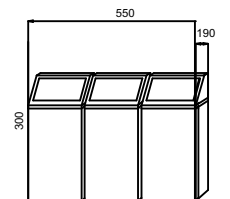

Gerİ Dönüşüm Çöp Kovaları Recycle Bins



Boyalı Geri Dönüşüm Kovaları Recycle Bins Open Cover Lid

			PRICE	
DKP	•818424	123x42x74 Üçlü / Triple	270 Lt. 346,50	1
	•818425	148x42x74 Dörtlü/Quartet	360 Lt. 435,11	1

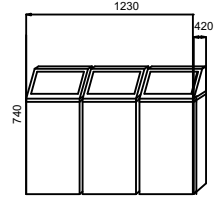

Gerİ Dönüşüm Kovaları Recycle Bins Open Cover Lid

			PRICE	
430K	•818426	35x30x75 İkilİ / Double	60 Lt. 433,48	1
	•818427	65x30x75 Üçlü / Triple	120 Lt. 491,13	1
	•818428	95x30x75 Dörtlü / Quartet	180 Lt. 570,37	1

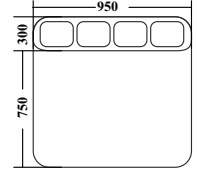

Gerİ Dönüşüm Kovaları Recycle Bins Open Cover Lid

			PRICE	
304K	•818325	30x60X60 İkilİ / Double	108 Lt. 562,13	1
	•818326	30X90X60 Üçlü / Triple	162 Lt. 836,53	1
	•818327	30X120X60 Dörtlü / Quartet	216 Lt. 1.108,27	1
DKP	•818455	30x60X60 İkilİ / Double	108 Lt. 270,00	1
	•818456	30X90X60 Üçlü / Triple	162 Lt. 404,93	1
	•818457	30X120X60 Dörtlü / Quartet	216 Lt. 536,67	1

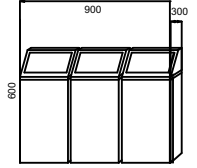

Gerİ Dönüşüm Kovaları Recycle Bins Open Cover Lid

			PRICE	
304K	•818332	50x25x70 İkilİ / Double	64 Lt. 627,47	1
	•818333	75x25x70 Üçlü / Triple	96 Lt. 941,60	1
	•818334	100x25x70 Dörtlü / Quartet	128 Lt. 1.248,27	1
DKP	•818432	50x25x70 İkilİ / Double	64 Lt. 321,73	1
	•818433	75x25x70 Üçlü / Triple	96 Lt. 482,53	1
	•818434	100x25x70 Dörtlü / Quartet	128 Lt. 643,33	1

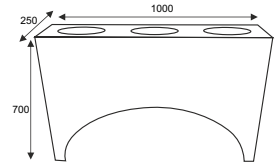

Gerİ Dönüşüm Kovaları Recycle Bins Open Cover Lid

			PRICE	
304K	•818322	50x25x70 İkilİ / Double	74 Lt. 919,20	1
	•818323	75x25x70 Üçlü / Triple	110 Lt. 1.378,40	1
	•818324	100x25x70 Dörtlü / Quartet	148 Lt. 1.838,40	1
DKP	•818452	50x25x70 İkilİ / Double	74 Lt. 578,27	1
	•818453	75x25x70 Üçlü / Triple	110 Lt. 866,13	1
	•818454	100x25x70 Dörtlü / Quartet	148 Lt. 1.155,73	1

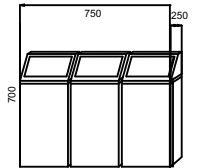

Gerİ Dönüşüm Kovaları Recycle Bins Open Cover Lid

			PRICE	
DKP	•818438	90x30x60 Üçlü / Triple	162 Lt. 196,61	1
	•818439	120x30x60 Dörtlü / Quartet	220 Lt. 245,77	1

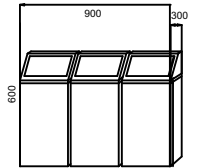

Gerİ Dönüşüm Kovaları Recycle Bins Open Cover Lid

			PRICE	
DKP	•818441	30x30x60 Kırmızı / Red	54 Lt. 61,52	1
	•818442	30x30x60 Yeşil / Green	54 Lt. 61,52	1
	•818443	30x30x60 Mavi / Blue	54 Lt. 61,52	1
	•818444	30x30x60 Sarı / Yellow	54 Lt. 61,52	1

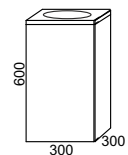

Paslanmaz Klozetler

Stainless Steel Toilets



Paslanmaz Klozet / Rezervuarlı
Stainless Steel Toilet / Reservoir

304K • **826300** H: 68cm W: 35x60cm

PRICE



1157,33

1

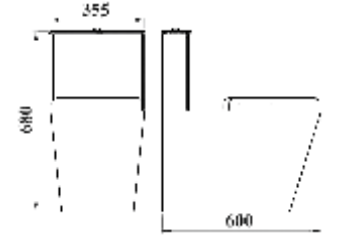

Paslanmaz Klozet
Stainless Steel Toilet

304K • **827300** H: 38,5cm W: 35,5x60cm

PRICE



989,33

1

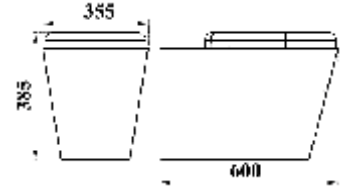

Paslanmaz Klozet Duvara Montaj
Stainless Steel Wall Mounted Toilet

304K • **828300** H: 37cm W: 35x56cm

PRICE



989,33

1

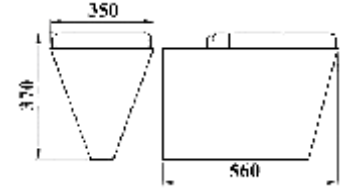

Paslanmaz Pisivuar
Stainless Steel Urinal

304K • **829300** H: 45cm W: 34x25cm

PRICE



970,67

1

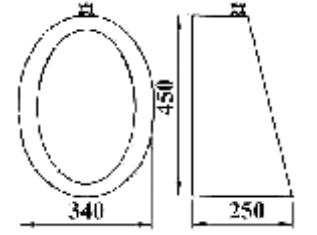

Paslanmaz Klozet / Lavabo
Stainless Steel Toilet / Sink

304K • **830300** H: 1,20cm W: 41x91cm

PRICE



2912,00

1

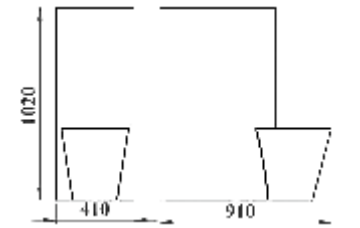

Paslanmaz Tuvalet / Jet Yıkamalı
Stainless Steel Pan Toilet / Jet Wash

304K • **831300** 60x65x17cm

PRICE



354,67

1

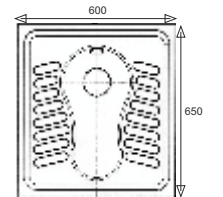

Paslanmaz Çoklu Pisivuar
Stainless Steel Multi-Urinal

304K • **832300** H: 54,5cm W: 120x280x24cm

PRICE



2284,80

1

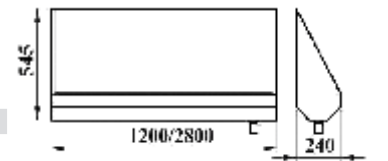

Paslanmaz Lavabolar

Stainless Steel Wash Basins



Paslanmaz Lavabo
Stainless Steel Wash Basin

PRICE 

304K • 833300 41x41x27cm 300,00 1

Musluksuz / No Tap

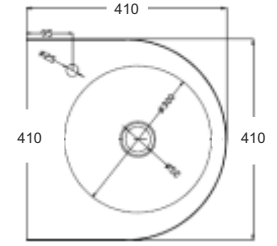

Paslanmaz Lavabo
Stainless Steel Wash Basin

PRICE 

304K • 833301 50x41,5x27cm 600,00 1

Musluksuz / No Tap

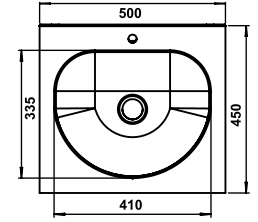

Paslanmaz Lavabo
Stainless Steel Wash Basin

PRICE 

304K • 833302 36,6x36x15,5cm 240,00 1

Musluksuz / No Tap

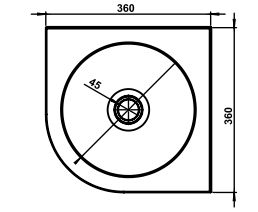

Paslanmaz Duş Teknesi
Stainless Steel Shower Basin

PRICE 

304K • 833303 80x80x20cm 400,00 1

Musluksuz / No Tap

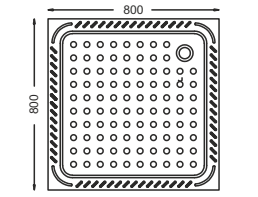

Paslanmaz Duş Teknesi
Stainless Steel Shower Basin

PRICE 

304K • 833304 70x70x20cm 660,00 1

Musluksuz / No Tap

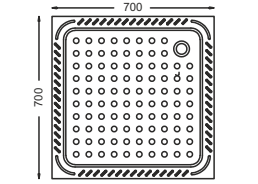

Pisuvlar Ara Bölme
Stainless Steel Urinal Partition

PRICE 

304K • 829301 39x76cm 360,00 1

Musluksuz / No Tap

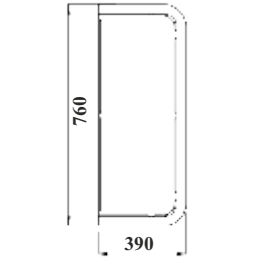

Paslanmaz Çelik Ayna
Stainless Steel Mirror

PRICE 

304K • 829302 60x40 100,00 1

• 829304 28,5x44 80,00 1

Musluksuz / No Tap

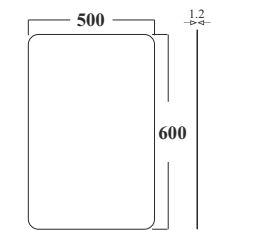

Paslanmaz Etajer
Stainless Steel Shelf

PRICE 

304K • 895101-1 48x15x2 cm 80,00 1

Musluksuz / No Tap

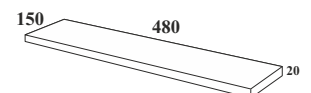

Medikal Ekipmanlar

Medical Equipments



Duvara Montajlı El Yıkama Ünitesi

Wall Mounted Hand Wash Unit

	PRICE	
304K • 837300 Dizden Vurmalı Batarya Knee Operated	349,27	1
• 838300 Fotoselli Batarya Photocell Operated	550,94	1



Maske / Bone / Galoş Seti

Mask / Bonnet / Overshoes Set

	PRICE	
304K • 839300 80x50x22cm	300,41	1
• 839301 Üst Takım /	144,27	
• 839302 Alt Takım		1



Paslanmaz Çelik Paspas

Stainless Steel Mats

	PRICE	
304K • 870300 40x60 cm	102,18	1
• 870301 60x90 cm	154,78	1
• 870302 60x120 cm	218,95	1



Aparat Yıkama Ünitesi

Washing Unit

	PRICE	
304K • 840300	Fiyat Sorunuz / Ask For Price	1



El Yıkama Ünitesi

Hand Wash Unit

	PRICE	
304K • 846300 Pedallı Batarya Pedal Operated	Fiyat Sorunuz / Ask For Price	1
• 846301 Bataryasız Without Tap	Fiyat Sorunuz / Ask For Price	1
• 847300 Fotoselli Batarya Photocell Operated	Fiyat Sorunuz / Ask For Price	1



Pansuman Arabası

Dressing Trolley

	PRICE	
304K • 848300	Fiyat Sorunuz / Ask For Price	1



Fotoselli El Yıkama Ünitesi

Hand Wash Unit Photocell Operated Faucets

	PRICE	
304K • 849300 Tekli / Single	Fiyat Sorunuz / Ask For Price	1
• 850300 İkili / Double	Fiyat Sorunuz / Ask For Price	1
• 851300 Üçlü / Triple	Fiyat Sorunuz / Ask For Price	1

Medikal Ekipmanlar

Medical Equipments



Çekmeceli Tezgah

Working Bench with Drawers

PRICE



304K • 841300

Fiyat Sorunuz / Ask For Price

1



Ay Masa / Moon Table

PRICE



304K • 842300

Fiyat Sorunuz / Ask For Price

1



Doktor El Yıkama Ünitesi

Medical Hand Wash Unit

PRICE



304K • 843300 Tekli / Single

Fiyat Sorunuz / Ask For Price

1

• 844300 İkili / Double

Fiyat Sorunuz / Ask For Price

• 845300 Üçlü / Triple

Fiyat Sorunuz / Ask For Price



Paketleme Masası / Packing Table

PRICE



304K • 852300

Fiyat Sorunuz / Ask For Price

1



Mayo Masa / Mayo Table

PRICE



304K • 853300 Mekanik / Mechanical

Fiyat Sorunuz / Ask For Price

1

• 854300 Hidrolik / Hydraulic

Fiyat Sorunuz / Ask For Price



Alet ve İlaç Dolabı

Tools and Medicine Cabinet

PRICE



304K • 855300

Fiyat Sorunuz / Ask For Price

1



Acil Duş ve Göz Yıkama Ünitesi

Emergency Shower & Eye Washing Unit

PRICE



304K • 859300

Fiyat Sorunuz / Ask For Price

1

DKP • 859400

Fiyat Sorunuz / Ask For Price

1

Acil Göz Yıkama Ünitesi

Emergency Eye Washing Unit

PRICE



304K • 860300

Fiyat Sorunuz / Ask For Price

1

DKP • 860400

Fiyat Sorunuz / Ask For Price

1

Sahil / Havuz Duşları Outdoor Showers

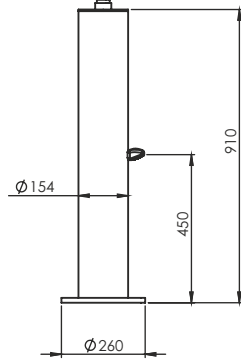

Serra

PRICE



304K • 888300	Yıkama/Zaman Ayarlı Feet Wash Push Tap	564	1
• 888301	Yıkama/Mix Bataryalı Feet Wash Push Tap	532	1

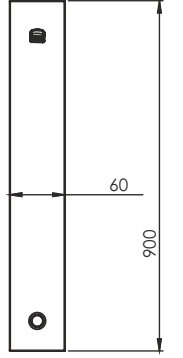

Platin

PRICE



304K • 891300	Duvara Monte Duş / Zaman Ayarlı Wall Mounted Shower / Push Tap	341	1
• 891301	Duvara Monte Duş / Mix Bataryalı Wall Mounted Shower / Mix Tap	383	1

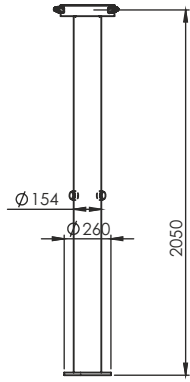

Lotus

PRICE



304K • 890300	2'li Zaman Ayarlı Double Push Tap	1.214	1
• 890301	3'lü Zaman Ayarlı Triple Push Tap	1.331	1
• 890302	3'lü Z.Ayarlı Tek Ayak Yık. Triple Push Tap One Feet Wash	1.448	1
• 890303	2'li Mix Bataryalı Double Mix Tap	1.129	1
• 890304	3'lü Mix Bataryalı Triple Mix Tap	1.203	1
• 890305	3'lü Mix Bataryalı + Tek Ayak Yıkamalı Triple Mix Tap + One Feet Wash	1.278	1

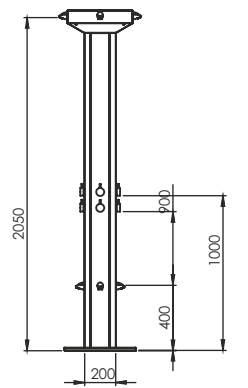

Galaxy

PRICE



304K • 889300	2'li Zaman Ayarlı Double Push Tap	1.214	1
• 889301	2'li Zam. Ayarlı + 2 Ayak Yıkam. Double Push Tap + Double Feet Wash	1.448	1
• 889302	2'li Mix Bataryalı Double Mix Tap	1.129	1
• 889303	2'li Mix Bataryalı + 2'li Ayak Yıkam. Double Mix Tap + Double Feet Wash	1.363	1
• 889304	2'li Mix Bataryalı Sıcak Soğuk Double Mix Tap Hot and Cold	1.235	1
• 889305	4'lü Zaman Ayarlı Four Push Tap	1.448	1
• 889306	4'lü Zaman Ayarlı + 4'lü Ayak Yıkam. Four Push Tap + Four Feet Wash	1.917	1
• 889307	4'lü Mix Bataryalı Four Mix Tap	1.278	1
• 889308	4'lü Mix Bataryalı + 4'lü Ayak Yıkam. Four Mix Tap + Four Feet Wash	1.746	1
• 889309	4'lü Mix Bataryalı Sıcak-Soğuk Four Mix Tap Hot and Cold	1.491	1

Sahil / Havuz Duşları

Outdoor Showers

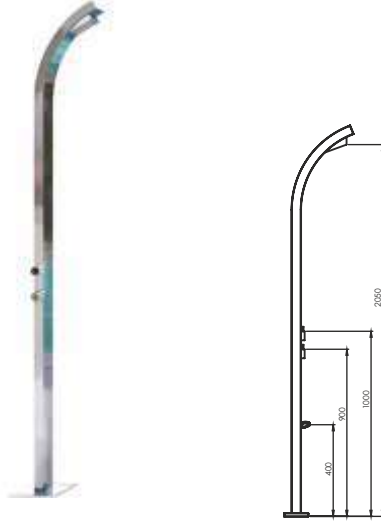

Retro

PRICE



304K • 892300	Zaman Ayarlı Push Tap	1.107	1
• 892301	Zaman Ayarlı + Ayak Yıkamalı Push Tap + Feet Wash	1.225	1
• 892302	Mix Bataryalı Mix Tap	1.107	1
• 892303	Mix Bataryalı + Ayak Yıkamalı Mix Tap + Feet Wash	1.225	1
• 892304	Mix Bataryalı Sıcak Soğuk Mix Tap Hot and Cold	1.256	1



Vigo

PRICE



304K • 893300	Mix Batarya Mix Tap	532	1
---------------	------------------------	-----	---

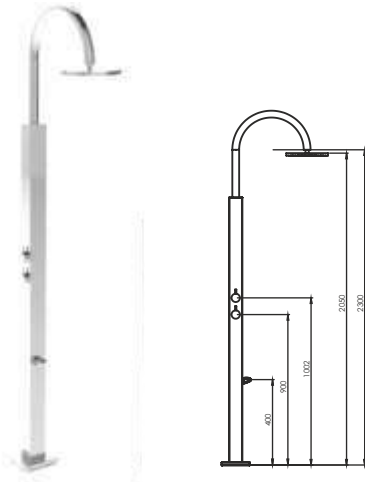

Artes

PRICE



304K • 894300	Zaman Ayarlı Duş Sistemi Push Tap Shower	767	1
• 894301	Zaman Ayarlı + Ayak Yıkamalı Push Tap Shower + Feet Wash	863	1
• 894302	Mix Bataryalı Duş Sistemi Mix Tap Shower	767	1
• 894303	Mix Bataryalı + Ayak Yıkamalı Mix Tap Shower + Feet Wash	863	1
• 894304	Mix Bataryalı Sıcak-Soğuk Mix Tap Shower Hot and Cold	820	1



Palmiye

PRICE



304K • 895300	Üçlü Zaman Ayarlı Duş Sistemi Triple Push Tap Shower	1.544	1
• 895301	Üçlü Ayak yıkamalı Zaman Ayarlı Duş Triple Feet Wash Push Tap	1.736	1

Sahil / Havuz Duşları

Outdoor Showers

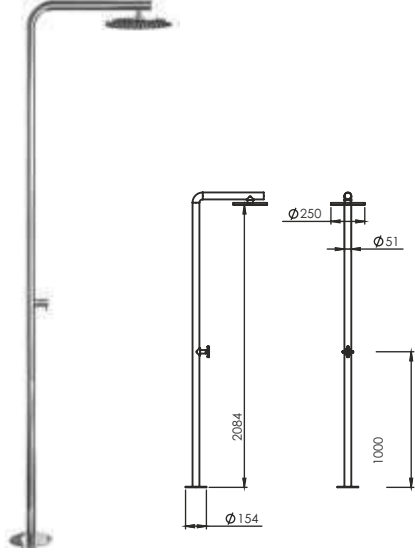

Nova

PRICE



304K • 898300 Mix Batarya
Mix Tap

575

1

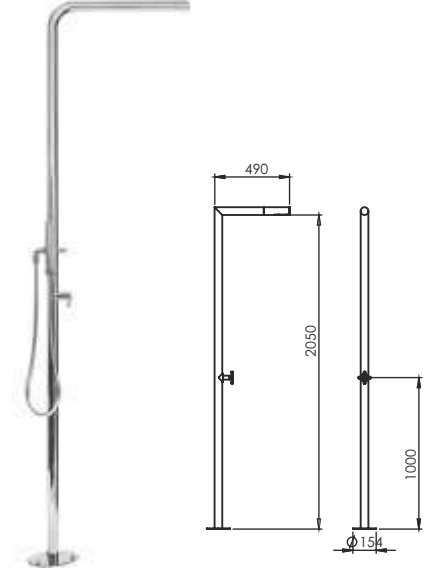

Plus

PRICE



304K • 898301 Mix Batarya
Mix Tap

681

1

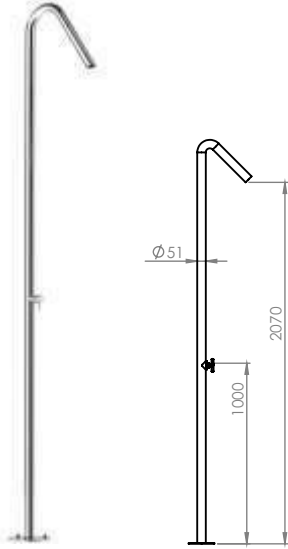

Quack

PRICE



304K • 898302 Mix Batarya
Mix Tap

831

1

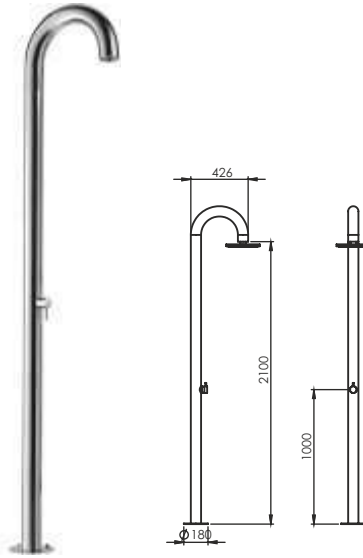

Brolly

PRICE



304K • 898303 Mix Batarya
Mix Tap

1.810

1

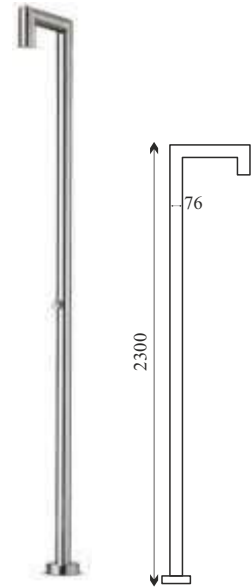

ibiza

PRICE



304K • 898304 Mix Batarya
Mix Tap

1.214

1

Duş Kanalları

Shower Drains



VEGA ECO Duş Kanalı
Paslanmaz Izgara
Klapeli Sulu Koku Tutucu

Plastik Gövde
Ø50

PRICE

9000-0120	20 cm Yan/Alt	17,96
9000-0230	30 cm Yan/Alt	22,56
9000-0340	40 cm Yan/Alt	25,71
9000-0450	50 cm Yan/Alt	29,93
9000-0560	60 cm Yan/Alt	32,46
9000-0670	70 cm Yan/Alt	37,60
9000-0780	80 cm Yan/Alt	41,21



360°

VEGA ECO-S Duş Kanalı
Paslanmaz Izgara
Klapeli Sulu Koku Tutucu

Plastik Gövde
Ø50

PRICE

9000-0820	20 cm Yan/Alt	28,09
9000-0930	30 cm Yan/Alt	30,62
9000-1040	40 cm Yan/Alt	33,15
9000-1150	50 cm Yan/Alt	37,22
9000-1260	60 cm Yan/Alt	40,60
9000-1370	70 cm Yan/Alt	43,59
9000-1480	80 cm Yan/Alt	48,12



VEGA ECO-Y Duş Kanalı
Paslanmaz Izgara
Klapeli Sulu Koku Tutucu

Plastik Gövde
Ø50

PRICE

9000-1520	20 cm Yan/Alt	25,55
9000-1630	30 cm Yan/Alt	28,55
9000-1740	40 cm Yan/Alt	31,54
9000-1850	50 cm Yan/Alt	35,99
9000-1960	60 cm Yan/Alt	40,52
9000-2070	70 cm Yan/Alt	44,97
9000-2180	80 cm Yan/Alt	49,50



360°

VEGA ECO-SY Duş Kanalı
Paslanmaz Izgara
Klapeli Sulu Koku Tutucu

Plastik Gövde
Ø50

PRICE

9000-2240	40 cm Yan/Alt	37,37
9000-2350	50 cm Yan/Alt	40,52
9000-2460	60 cm Yan/Alt	45,02
9000-2570	70 cm Yan/Alt	47,27
9000-2680	80 cm Yan/Alt	50,93



VEGA LUX Duş Kanalı
Paslanmaz Izgara
Klapeli Sulu Koku Tutucu

Plastik Gövde
Ø50

PRICE

9000-2720	20 cm Yan/Alt	22,58
9000-2830	30 cm Yan/Alt	27,10
9000-2940	40 cm Yan/Alt	32,21
9000-3050	50 cm Yan/Alt	36,42
9000-3160	60 cm Yan/Alt	41,53
9000-3270	70 cm Yan/Alt	46,34
9000-3380	80 cm Yan/Alt	49,37



360°

VEGA LUX-S Duş Kanalı
Paslanmaz Izgara
Klapeli Sulu Koku Tutucu

Plastik Gövde
Ø50

PRICE

9000-3420	20 cm Yan/Alt	31,58
9000-3530	30 cm Yan/Alt	34,61
9000-3640	40 cm Yan/Alt	39,08
9000-3750	50 cm Yan/Alt	43,64
9000-3860	60 cm Yan/Alt	48,17
9000-3970	70 cm Yan/Alt	52,67
9000-4080	80 cm Yan/Alt	55,63



STAR

RAIN

DOLU

BLACK

PVD

Duş Kanalları

Shower Drains



VEGA LUX-Y Duş Kanalı
Paslanmaz Izgara
Klapeli Sulu Koku Tutucu

Plastik Gövde
Ø50

PRICE

9000-4120	20 cm Yan/Alt	27,86
9000-4230	30 cm Yan/Alt	30,93
9000-4340	40 cm Yan/Alt	37,03
9000-4450	50 cm Yan/Alt	42,49
9000-4560	60 cm Yan/Alt	46,99
9000-4670	70 cm Yan/Alt	52,62
9000-4780	80 cm Yan/Alt	57,12



VEGA LUX-SY Duş Kanalı
Paslanmaz Izgara
Klapeli Sulu Koku Tutucu

360°

Plastik Gövde
Ø50

PRICE

9000-4840	40 cm Yan/Alt	42,44
9000-4950	50 cm Yan/Alt	46,43
9000-5060	60 cm Yan/Alt	50,09
9000-5170	70 cm Yan/Alt	54,80
9000-5280	80 cm Yan/Alt	59,09



VEGA SERA Duş Kanalı
Paslanmaz Izgara
Klapeli Sulu Koku Tutucu

Plastik Gövde
Ø50

PRICE

9000-5320	20 cm Yan/Alt	24,09
9000-5430	30 cm Yan/Alt	28,60
9000-5540	40 cm Yan/Alt	33,71
9000-5670	50 cm Yan/Alt	37,63
9000-5760	60 cm Yan/Alt	43,05
9000-5870	70 cm Yan/Alt	47,87
9000-5880	80 cm Yan/Alt	50,88



VEGA SERA-S Duş Kanalı
Paslanmaz Izgara
Klapeli Sulu Koku Tutucu

360°

Plastik Gövde
Ø50

PRICE

9000-6020	20 cm Yan/Alt	33,12
9000-6130	30 cm Yan/Alt	36,13
9000-6240	40 cm Yan/Alt	40,65
9000-6350	50 cm Yan/Alt	45,16
9000-6460	60 cm Yan/Alt	49,68
9000-6570	70 cm Yan/Alt	54,19
9000-6680	80 cm Yan/Alt	57,21



VEGA SERA-Y Duş Kanalı
Paslanmaz Izgara
Klapeli Sulu Koku Tutucu

Plastik Gövde
Ø50

PRICE

9000-6720	20 cm Yan/Alt	28,90
9000-6830	30 cm Yan/Alt	31,61
9000-6940	40 cm Yan/Alt	38,53
9000-7050	50 cm Yan/Alt	43,66
9000-7160	60 cm Yan/Alt	48,12
9000-7270	70 cm Yan/Alt	52,69
9000-7380	80 cm Yan/Alt	57,12



VEGA SERA-SY Duş Kanalı
Paslanmaz Izgara
Klapeli Sulu Koku Tutucu

360°

Plastik Gövde
Ø50

PRICE

9000-7440	40 cm Yan/Alt	43,66
9000-7550	50 cm Yan/Alt	48,12
9000-7660	60 cm Yan/Alt	52,69
9000-7770	70 cm Yan/Alt	56,84
9000-7880	80 cm Yan/Alt	60,22



STAR



RAIN



DOLU



BLACK



PVD

Duş Kanalları

Shower Drains



VEGA STYLE Duş Kanalı
Paslanmaz Izgara
Klapeli Sulu Koku Tutucu

Plastik Gövde
Ø50

PRICE

9001-7920	20 cm Yan/Alt
9001-8030	30 cm Yan/Alt
9001-8140	40 cm Yan/Alt
9001-8250	50 cm Yan/Alt
9001-8360	60 cm Yan/Alt

20,77
26,19
32,37
37,94
43,51



VEGA STYLE-S Duş Kanalı
Paslanmaz Izgara
Klapeli Sulu Koku Tutucu

Plastik Gövde
Ø50

PRICE

9001-8420	20 cm Yan/Alt
9001-8530	30 cm Yan/Alt
9001-8640	40 cm Yan/Alt
9001-8750	50 cm Yan/Alt
9001-8860	60 cm Yan/Alt

27,40
34,65
38,54
43,96
48,17



VEGA STYLE-Y Duş Kanalı
Paslanmaz Izgara
Klapeli Sulu Koku Tutucu

Plastik Gövde
Ø50

PRICE

9001-8920	20 cm Yan/Alt
9001-9030	30 cm Yan/Alt
9001-9140	40 cm Yan/Alt
9001-9250	50 cm Yan/Alt
9001-9360	60 cm Yan/Alt

24,09
30,71
35,53
41,55
46,37



VEGA STYLE-SY Duş Kanalı
Paslanmaz Izgara
Klapeli Sulu Koku Tutucu

Plastik Gövde
Ø50

PRICE

9001-9420	40 cm Yan/Alt
9001-9530	50 cm Yan/Alt
9001-9640	60 cm Yan/Alt
9001-9750	70 cm Yan/Alt
9001-9860	80 cm Yan/Alt

30,41
37,03
42,45
48,17
53,59



VEGA ELİPS-S Duş Kanalı
Paslanmaz Izgara
Klapeli Sulu Koku Tutucu

Plastik Gövde
Ø50

PRICE

9001-0120	20 cm Yan/Alt
9001-0230	30 cm Yan/Alt
9001-0340	40 cm Yan/Alt
9001-0450	50 cm Yan/Alt
9001-0560	60 cm Yan/Alt
9001-0670	70 cm Yan/Alt
9001-0780	80 cm Yan/Alt

36,73
39,14
43,05
47,57
52,09
56,30
60,07



VEGA ELİPS-S Duş Kanalı
Paslanmaz Izgara
Klapeli Sulu Koku Tutucu

Plastik Gövde
Ø50

PRICE

9001-0920	20 cm Yan/Alt
9001-0930	30 cm Yan/Alt
9001-1040	40 cm Yan/Alt
9001-1150	50 cm Yan/Alt
9001-1260	60 cm Yan/Alt
9001-1370	70 cm Yan/Alt
9001-1480	80 cm Yan/Alt

32,82
36,13
41,70
46,67
51,48
57,21
61,27



VEGA ELİPS-YS Duş Kanalı
Paslanmaz Izgara
Klapeli Sulu Koku Tutucu

Plastik Gövde
Ø50

PRICE

9001-1520	40 cm Yan/Alt
9001-1630	50 cm Yan/Alt
9001-1740	60 cm Yan/Alt
9001-1850	70 cm Yan/Alt
9001-1960	80 cm Yan/Alt

46,91
51,18
54,50
59,01
63,08



ELİPS SERA-S Duş Kanalı
Paslanmaz Izgara
Klapeli Sulu Koku Tutucu

Plastik Gövde
Ø50

PRICE

9001-3520	20 cm Yan/Alt
9001-3630	30 cm Yan/Alt
9001-3740	40 cm Yan/Alt
9001-3850	50 cm Yan/Alt
9001-3960	60 cm Yan/Alt
9001-4070	70 cm Yan/Alt
9001-4180	80 cm Yan/Alt

38,27
41,10
44,71
49,98
53,29
58,11
61,12



STAR



RAIN



DOLU



BLACK



PVD

Duş Kanalları

Shower Drains



ELİPS SERA-Y Duş Kanalı
Paslanmaz Izgara
Klapeli Sulu Koku Tutucu

Plastik Gövde
Ø50

PRICE

9001-4220	20 cm Yan/Alt	33,72
9001-4330	30 cm Yan/Alt	36,88
9001-4440	40 cm Yan/Alt	43,05
9001-4550	50 cm Yan/Alt	48,17
9001-4660	60 cm Yan/Alt	52,69
9001-4770	70 cm Yan/Alt	58,41
9001-4880	80 cm Yan/Alt	62,32



ELİPS SERA-YS Duş Kanalı
Paslanmaz Izgara
Klapeli Sulu Koku Tutucu

Plastik Gövde
Ø50

PRICE

9001-4920	40 cm Yan/Alt	48,17
9001-5030	50 cm Yan/Alt	52,09
9001-5140	60 cm Yan/Alt	55,78
9001-5250	70 cm Yan/Alt	60,52
9001-5360	80 cm Yan/Alt	64,13



STYLE ELİPS-S Duş Kanalı
Paslanmaz Izgara
Klapeli Sulu Koku Tutucu

Plastik Gövde
Ø50

PRICE

9001-5420	20 cm Yan/Alt	33,12
9001-5530	30 cm Yan/Alt	38,99
9001-5640	40 cm Yan/Alt	44,56
9001-5750	50 cm Yan/Alt	49,68
9001-5860	60 cm Yan/Alt	54,19



STYLE ELİPS-Y Duş Kanalı
Paslanmaz Izgara
Klapeli Sulu Koku Tutucu

Plastik Gövde
Ø50

PRICE

9001-5920	20 cm Yan/Alt	29,94
9001-6030	30 cm Yan/Alt	36,67
9001-6140	40 cm Yan/Alt	41,25
9001-6250	50 cm Yan/Alt	47,42
9001-6360	60 cm Yan/Alt	52,39



STYLE ELİPS-YS Duş Kanalı
Paslanmaz Izgara
Klapeli Sulu Koku Tutucu

Plastik Gövde
Ø50

PRICE

9001-6420	20 cm Yan/Alt	36,28
9001-6530	30 cm Yan/Alt	42,96
9001-6640	40 cm Yan/Alt	48,17
9001-6750	50 cm Yan/Alt	54,19
9001-6860	60 cm Yan/Alt	59,61



STYLE ELİPS-S Duş Kanalı
Paslanmaz Izgara
Klapeli Sulu Koku Tutucu

Plastik Gövde
Ø50

PRICE

9001-8530	30 cm Yan/Alt	62,00
9001-8640	40 cm Yan/Alt	73,90
9001-8750	50 cm Yan/Alt	84,03
9001-8860	60 cm Yan/Alt	97,99



VEGA PLAST-S Duş Kanalı
Paslanmaz Izgara
Klapeli Sulu Koku Tutucu

Plastik Gövde
Ø50

PRICE

9001-6930	30 cm Yan/Alt	16,63
9001-7040	40 cm Yan/Alt	19,19
9001-7150	50 cm Yan/Alt	21,74
9001-7260	60 cm Yan/Alt	24,30



VEGA PLAST SERA-S Duş Kanalı
Paslanmaz Izgara
Klapeli Sulu Koku Tutucu

Plastik Gövde
Ø50

PRICE

9001-7330	30 cm Yan/Alt	17,39
9001-7440	40 cm Yan/Alt	19,95
9001-7550	50 cm Yan/Alt	22,51
9001-7660	60 cm Yan/Alt	25,07

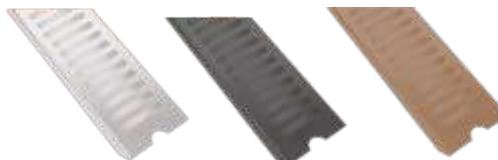

NORMA

BLACK

PVD

Yer Süzgeçleri

Floor Drains



Yer Sifonu
10x10 Yan Çıkış

9002-0110

PRICE

2,05



Yer Sifonu
10x10 Alt Çıkış

9002-0210

PRICE

2,05



Yer Sifonu
15x15 Yan Çıkış

9002-0315

PRICE

4,09



Yer Sifonu
15x15 Alt Çıkış

9002-0415

PRICE

4,09



Yer Sifonu Sulu Klapele
10x10 Yan Çıkış

9002-0510

PRICE

3,07



Yer Sifonu Sulu Klapele
10x10 Alt Çıkış

9002-0610

PRICE

3,07



Yer Sifonu Sulu Klapele
15x15 Yan Çıkış

9002-0715

PRICE

5,12



Yer Sifonu Sulu Klapele
15x15 Alt Çıkış

9002-0815

PRICE

5,12



Paslanmaz
Kanal Izgarası

9002-0916 130x500

PRICE

23,26

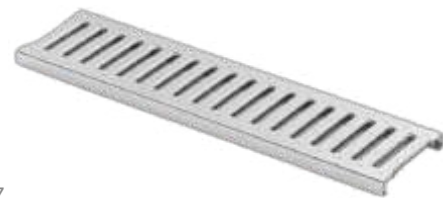

Galvaniz
Kanal Izgarası

9002-1018 130x500

PRICE

8,98

neksi®



Banyo Aksesuarları
Bathroom Accessories

Avatar Serisi

Avatar Series



895101
Etajer
Glass Shelf

PRICE
19,18



895102
Uzun Havluluk
Towel Bar

PRICE
19,15



895103
Halka Havluluk
Towel Ring

PRICE
11,81



895104
Havlu Kağıtlık
Towel Paper Holder

PRICE
12,41



895105
Kapaklı Havlu Kağıtlık
Towel Paper Holder With Lid

PRICE
14,95



895106
Tuvalet Kağıtlık
Toilet Roll Holder

PRICE
10,89



895107
Kapaklı Tuvalet Kağıtlık
Toilet Roll Holder With Lid

PRICE
13,44



895108
Diş Fırçalık
Toothbrush Holder

PRICE
9,52



895109
Sabunluk
Soap Dish Holder

PRICE
9,97



895110
Tekli Askılık
Robe Hook

PRICE
8,68



895111
İkili Askılık
Double Robe Hook

PRICE
9,72



895112
Tuvalet Kağıtlık Bekletmeli
Spare Toilet Roll Holder

PRICE
15,28



895113
İkili Tuvalet Kağıtlık
Double Toilet Roll Holder

PRICE
12,56



895114
Metal Klozet Fırçası
Metal Toilet Brush

PRICE
29,43

Julia Serisi

Julia Series



Uzun Havluluk
Towel Bar

900546	Krom/Chrome
900547	Altın/Gold
900548	Antik/Antique

PRICE

68,69
88,85
83,07



Halka Havluluk
Towel Ring

900549	Krom/Chrome
900550	Altın/Gold
900551	Antik/Antique

PRICE

56,37
74,11
67,76



Tekli Askılık
Robe Hook

900558	Krom/Chrome
900559	Altın/Gold
900560	Antik/Antique

PRICE

38,83
50,03
45,73



Tuvalet Kağıtlık
Toilet Roll Holder

900555	Krom/Chrome
900556	Altın/Gold
900557	Antik/Antique

PRICE

52,08
69,81
63,47



Kapaklı Tuvalet Kağıtlık
Toilet Roll Holder With Lid

900552	Krom/Chrome
900553	Altın/Gold
900554	Antik/Antique

PRICE

65,33
84,75
77,65



Yedek Kağıtlık Bekletme
Spare Toilet Roll Holder

900555	Krom/Chrome
900556	Altın/Gold
900557	Antik/Antique

PRICE

52,08
69,81
63,47



Diş Fırçalık
Toothbrush Holder

900564	Krom/Chrome
900565	Altın/Gold
900566	Antik/Antique

PRICE

49,47
64,40
58,99



Sabunluk
Soap Dish Holder

900561	Krom/Chrome
900562	Altın/Gold
900563	Antik/Antique

PRICE

49,47
64,40
58,99



Sıvı Sabunluk
Soap Dispenser

900564	Krom/Chrome
900565	Altın/Gold
900566	Antik/Antique

PRICE

30,00
31,11
32,00



Klozet Fırçası
Toilet Brush Holder

900567	Krom/Chrome
900568	Altın/Gold
900569	Antik/Antique

PRICE

72,43
94,27
86,61

Ania Serisi

Ania Series



Uzun Havluluk
Towel Bar

900621 Krom/Chrome

PRICE
69,81



Tuvalet Kağıtlık
Toilet Roll Holder

900622 Krom/Chrome

PRICE
41,07



Halka Havluluk
Towel Ring

900623 Krom/Chrome

PRICE
64,96



Tekli Askılık
Robe Hook Single

900625 Krom/Chrome

PRICE
34,72



Tekli Askılık
Robe Hook Single

900630 Krom/Chrome

PRICE
38,83



İkili Askılık
Robe Hook Double

900624 Krom/Chrome

PRICE
29,87



İkili Askılık
Robe Hook Double

900626 Krom/Chrome

PRICE
46,59



Kapalı Tuvalet Kağıtlık
Toilet Roll Holder With Lid

900627 Krom/Chrome

PRICE
58,80



Sabunluk
Soap Dish Holder

900628 Krom/Chrome

PRICE
39,39



Diş Fırçalık
Toothbrush Holder

900629 Krom/Chrome

PRICE
39,39



Cam Klozet Fırçası
Glass Toilet Brush Holder

900630 Krom/Chrome

PRICE
79,33

Alya Serisi

Alya Series



Uzun Havluluk
Towel Bar

PRICE

900401	Krom/Chrome	49,84
900402	Altın/Gold	64,40
900403	Antik/Antique	59,55



Halka Havluluk
Towel Ring

PRICE

900404	Krom/Chrome	25,20
900405	Altın/Gold	33,04
900406	Antik/Antique	30,24



Tuvalet Kağıtlık
Toilet Roll Holder

PRICE

900413	Krom/Chrome	32,48
900414	Altın/Gold	42,19
900415	Antik/Antique	39,01



Sıvı Sabunluk
Soap Dispenser

PRICE

900407	Krom/Chrome	27,44
900408	Altın/Gold	33,60
900409	Antik/Antique	31,17



Kapaklı Tuvalet Kağıtlık
Toilet Roll Holder With Lid

PRICE

900410	Krom/Chrome	33,60
900411	Altın/Gold	43,31
900412	Antik/Antique	40,13



İkili Tuvalet Kağıtlık
Double Toilet Roll Holder

PRICE

900413	Krom/Chrome	32,48
900414	Altın/Gold	42,19
900415	Antik/Antique	39,01



Dis Fırçalık
Toothbrush Holder

PRICE

900416	Krom/Chrome	26,13
900417	Altın/Gold	33,97
900418	Antik/Antique	31,17



Sabunluk
Soap Dish Holder

PRICE

900419	Krom/Chrome	26,13
900420	Altın/Gold	33,97
900421	Antik/Antique	31,17



Tekli Askılık
Robe Hook Single

PRICE

900422	Krom/Chrome	22,68
900423	Altın/Gold	29,74
900424	Antik/Antique	27,22



İkili Askılık
Double Robe Hook

PRICE

900425	Krom/Chrome	25,20
900426	Altın/Gold	33,04
900427	Antik/Antique	30,24



Dörtlü Askılık
Robe Hanger With 4 Hooks

PRICE

900428	Krom/Chrome	52,64
900429	Altın/Gold	50,03
900430	Antik/Antique	63,09



Cam Klozet Fırçası
Glass Toilet Brush Holder

PRICE

900431	Krom/Chrome	58,61
900432	Altın/Gold	75,79
900433	Antik/Antique	70,37

Titan Serisi

Titan Series



Etajer /
Glass Shelf

900701	Krom / Chrome	42,23
900701-1	Altın / Gold	56,68
900701-2	Siyah / Black	56,68



Krom/Chrome



Siyah/Black

PRICE

42,23
56,68
56,68



Uzun Havluluk
Towel Bar

900702	Krom / Chrome	29,98
900702-1	Altın / Gold	40,94
900702-2	Siyah / Black	40,94

PRICE

29,98
40,94
40,94



Halka Havluluk
Towel Ring Holder

900703	Krom / Chrome	21,21
900703-1	Altın / Gold	31,08
900703-2	Siyah / Black	31,08

PRICE

21,21
31,08
31,08



Havluluk
Towel Holder

900710	Krom / Chrome	23,85
900710-1	Altın / Gold	36,74
900710-2	Siyah / Black	36,73

PRICE

23,85
36,74
36,73



Kapaklı
Tuvalet Kağıtlık
Toilet Roll Holder
With Lid

900704	Krom / Chrome	26,03
900704-1	Altın / Gold	37,10
900704-2	Siyah / Black	37,10

PRICE

26,03
37,10
37,10



Tuvalet Kağıtlık
Toilet Roll Holder

900707	Krom / Chrome	17,59
900707-1	Altın / Gold	23,96
900707-2	Siyah / Black	23,96

PRICE

17,59
23,96
23,96



İkili Askılık
Double
Robe Hook

900705	Krom / Chrome	17,31
900705-1	Altın / Gold	23,85
900705-2	Siyah / Black	23,85

PRICE

17,31
23,85
23,85



Havlu Kağıtlık
Towel Paper Holder

900709	Krom / Chrome	19,57
900709-1	Altın / Gold	26,85
900709-2	Siyah / Black	26,85

PRICE

19,57
26,85
26,85



Diş Fırçalık
Toothbrush Holder

900708	Krom / Chrome	18,21
900708-1	Altın / Gold	24,02
900708-2	Siyah / Black	24,02

PRICE

18,21
24,02
24,02



Sabunluk
Soap Dish Holder

900706	Krom / Chrome	19,80
900706-1	Altın / Gold	25,58
900706-2	Siyah / Black	25,58

PRICE

19,80
25,58
25,58

Andro Serisi

Andro Series



PRICE

Etajer Glass Shelf	9001500	Krom / Chrome	16,43
	9001500-1	Altın / Gold	23,30
	9001500-2	Siyah / Black	23,30
	9001500-3	Antik / Antique	23,30
	9001500-4	Rose / Rose	23,30



PRICE

Uzun Havluluk Towel Bar	9001501	Krom / Chrome	16,76
	9001501-1	Altın / Gold	27,94
	9001501-2	Siyah / Black	27,94
	9001501-3	Antik / Antique	27,94
	9001501-4	Rose / Rose	27,94

Altın
GoldMat Siyah
Mat BlackKrom
ChromeRose
Rose

Halka Havluluk
Ring Towel Holder

PRICE

9001502	Krom / Chrome	10,43
9001502-1	Altın / Gold	25,63
9001502-2	Siyah / Black	25,63
9001502-3	Antik / Antique	25,63
9001502-4	Rose / Rose	25,63

**Kapaklı
Tuvalet Kağıtlık**
With Lid Toilet Roll Holder

PRICE

9001505	Krom / Chrome	12,05
9001505-1	Altın / Gold	27,56
9001505-2	Siyah / Black	27,56
9001505-3	Antik / Antique	27,56
9001505-4	Rose / Rose	27,56

Tuvalet Kağıtlık
Toilet Roll Holder

PRICE

9001506	Krom / Chrome	10,85
9001506-1	Altın / Gold	16,79
9001506-2	Siyah / Black	16,79
9001506-3	Antik / Antique	16,79
9001506-4	Rose / Rose	16,79



Sabunluk
Soap Dish Holder

PRICE

9001507	Krom / Chrome	12,57
9001507-1	Altın / Gold	16,26
9001507-2	Siyah / Black	16,26
9001507-3	Antik / Antique	16,26
9001507-4	Rose / Rose	16,26

**Kapaklı
Havlu Kağıtlık**
Towel Paper Holder With Lid

PRICE

9001503	Krom / Chrome	15,02
9001503-1	Altın / Gold	31,58
9001503-2	Siyah / Black	31,58
9001503-3	Antik / Antique	31,58
9001503-4	Rose / Rose	31,58

Havlu Kağıtlık
Towel Paper Holder

PRICE

9001504	Krom / Chrome	13,60
9001504-1	Altın / Gold	21,03
9001504-2	Siyah / Black	21,03
9001504-3	Antik / Antique	21,03
9001504-4	Rose / Rose	21,03



Diş Fırçalık
Toothbrush Holder

PRICE

9001508	Krom / Chrome	12,57
9001508-1	Altın / Gold	16,26
9001508-2	Siyah / Black	16,26
9001508-3	Antik / Antique	16,26
9001508-4	Rose / Rose	16,26

İkili Askılık
Double Robe Hook

PRICE

9001509	Krom / Chrome	8,12
9001509-1	Altın / Gold	11,70
9001509-2	Siyah / Black	11,70
9001509-3	Antik / Antique	11,70
9001509-4	Rose / Rose	11,70

Havluluk
Towel Holder

PRICE

9001510	Krom / Chrome	21,56
9001510-1	Altın / Gold	30,72
9001510-2	Siyah / Black	30,72
9001510-3	Antik / Antique	30,72
9001510-4	Rose / Rose	30,72

Leo Serisi

Leo Series



Uzun Havluluk
Towel Bar

9001800	Altın / Gold
9001800-1	Antik / Antique
9001800-2	Krom / Chrome

PRICE
85,66
85,66
57,69



Antik / Antique



Krom / Chrome



Halka Havluluk
Towel Ring

9001801	Altın / Gold
9001801-1	Antik / Antique
9001801-2	Krom / Chrome

PRICE
62,50
62,50
41,08



Tuvalet Kağıtlık
Toilet Roll Holder

9001805	Altın / Gold
9001805-1	Antik / Antique
9001805-2	Krom / Chrome

PRICE
49,60
49,60
33,65



Tuvalet Kağıtlık
Toilet Roll Holder

9001806	Altın / Gold
9001806-1	Antik / Antique
9001806-2	Krom / Chrome

PRICE
39,77
39,77
26,88



Kapaklı
Tuvalet Kağıtlık
Toilet Roll Holder With Lid

9001807	Altın / Gold
9001807-1	Antik / Antique
9001807-2	Krom / Chrome

PRICE
43,27
43,27
30,16



Kapaklı
Tuvalet Kağıtlık
Toilet Roll Holder With Lid

9001808	Altın / Gold
9001808-1	Antik / Antique
9001808-2	Krom / Chrome

PRICE
64,46
64,46
42,83



Yedek
Tuvalet Kağıtlık
Spare Roll Holder

9001809	Altın / Gold
9001809-1	Antik / Antique
9001809-2	Krom / Chrome

PRICE
57,47
57,47
38,24



Tekli Askılık
Single Robe Hook

9001810	Altın / Gold
9001810-1	Antik / Antique
9001810-2	Krom / Chrome

PRICE
35,40
35,40
21,63



Tekli Askılık
Single Robe Hook

9001811	Altın / Gold
9001811-1	Antik / Antique
9001811-2	Krom / Chrome

PRICE
46,33
46,33
30,37



İkili Askılık
Double Robe Hook

9001812	Altın / Gold
9001812-1	Antik / Antique
9001812-2	Krom / Chrome

PRICE
49,82
49,82
33,65

Capella Serisi

Capella Series



Uzun Havluluk
Towel Bar

9001600 Krom / Chrome
9001600-1 Siyah / Black

PRICE

34,44
37,78



Raf Havluluk
Towel Bar

9001609 Krom / Chrome
9001609-1 Siyah / Black

Krom / Chrome

PRICE

63,89
65,56



Uzun Havluluk
Towel Bar

9001601 Krom / Chrome
9001601-1 Siyah / Black

PRICE

41,11
42,78



Sabunluk
Soap Dish Holder

9001602 Krom / Chrome
9001602-1 Siyah / Black

PRICE

20,22
21,11



Diş Fırçalık
Toothbrush Holder

9001603 Krom / Chrome
9001603-1 Siyah / Black

PRICE

20,22
21,11



Tuvalet Kağıtlık
Toilet Roll Holder

9001604 Krom / Chrome
9001604-1 Siyah / Black

PRICE

13,89
15,00



Havluluk
Towel Paper Holder

9001605 Krom / Chrome
9001605-1 Siyah / Black

PRICE

16,67
17,22



Tekli Askılık
Single Robe Hook

9001606 Krom / Chrome
9001606-1 Siyah / Black

PRICE

7,22
8,00



İkili Askılık
Double Robe Hook

9001607 Krom / Chrome
9001607-1 Siyah / Black

PRICE

12,22
13,11



Klozet Fırçası Cam
Toilet Brush Glass

9001608 Krom / Chrome
9001608-1 Siyah / Black

PRICE

30,00
31,11

Sirius Serisi

Sirius Series



Siyah / Black



Etajer
Glass Shelf
9001100

PRICE
39,43



Uzun Havluluk
Towel Bar
9001101

PRICE
43,81



Halka Havluluk
Towel Ring
9001102

PRICE
28,65



Tuvalet Kağıtlık
Toilet Roll Holder
9001103

PRICE
23,59



Kapaklı Tuvalet Kağıtlık
Toilet Roll Holder With Lid
9001104

PRICE
25,76



İkili Askılık
Double Robe Hook
9001105

PRICE
20,34



Sabunluk
Soap Dish Holder
9001106

PRICE
26,96



Diş Fırçalık
Toothbrush Holder
9001107

PRICE
26,96

Sirius Serisi

Sirius Series



9001108
İkili Tuvalet Kağıtlık
Double Toilet Roll Holder

PRICE
37,24



9001109
Tekli Askılık
Robe Hook

PRICE
21,36



9001110
İkili Askılık
Double Robe Hook

PRICE
29,90



9001111
Üçlü Askılık
Triple Robe Hook

PRICE
38,45



9001112
Cam Sıvı Sabunluk
Soap Dispenser Glass

PRICE
64,71



9001114
Klozet Fırçası
Toilet Brush Holder

PRICE
53,93

Electra Serisi

Electra Series



9001700
Uzun Havluluk
Towel Bar

PRICE
33,46



9001701
Halka Havluluk
Ring Towel Holder

PRICE
19,86



9001702
Kapaklı Havlu Kağıtlık
With Lid Towel Paper Holder

PRICE
27,08



9001703
Tuvalet Kağıtlık
Toilet Roll Holder

PRICE
20,94



9001704
Kapaklı Tuvalet Kağıtlık
With Lid Toilet Roll Holder

PRICE
25,52



9001705
Kapaklı Tuvalet Kağıtlık Bekletmeli
Toilet Roll Holder with Spare Roll Holder

PRICE
35,73



9001706
Yedek Tuvalet Kağıtlık
Spare Roll Holder

PRICE
44,54



9001707
Diş Fırçalık
Toothbrush Holder

PRICE
27,69



9001708
Sabunluk
Soap Dish Holder

PRICE
27,69



9001709
Tekli Askılık
Single Robe Hook

PRICE
15,89



9001710
İkili Askılık
Double Robe Hook

PRICE
17,33

Ares Serisi

Ares Series



Etajer /
Glass Shelf

900301 Krom/Chrome
900301-1 Siyah/Black

PRICE

26,22
31,37



Siyah / Black



Uzun Havluluk
Towel Bar

PRICE

900302 Krom/Chrome
900302-1 Siyah/Black

31,37
37,64



Havlu Kağıtlık
Towel Paper Holder

PRICE

900303 Krom/Chrome
900303-1 Siyah/Black

19,27
23,08



Tuvalet Kağıtlık
Toilet Roll Holder

PRICE

900304 Krom/Chrome
900304-1 Siyah/Black

18,82
22,63



Kapaklı Tuvalet Kağıtlık
Toilet Roll Holder With Lid

PRICE

900305 Krom/Chrome
900305-1 Siyah/Black

24,42
29,35



İkili Askılık
Double Robe Hook

PRICE

900306 Krom/Chrome
900306-1 Siyah/Black

15,46
18,60



Yedek Kağıtlık Bekletme
Spare Toilet Roll Holder

PRICE

900307 Krom/Chrome
900307-1 Siyah/Black

17,34
20,77



Diş Fırçalık
Toothbrush Holder

PRICE

900308 Krom/Chrome
900308-1 Siyah/Black

17,93
21,96



Sabunluk
Soap Dish Holder

PRICE

900309 Krom/Chrome
900309-1 Siyah/Black

17,93
21,96



Cam Klozet Fırçası
Glass Toilet Brush Holder

PRICE

900310 Krom/Chrome
900310-1 Siyah/Black

41,23
49,52

Hanya Serisi

Hanya Series



900200
Etajer
Glass Shelf

PRICE
22,89



900201
Uzun Havluluk
Towel Bar

PRICE
42,00



900202
Halka Havluluk
Towel Ring

PRICE
17,40



900203
Halka Havluluk
Towel Ring

PRICE
19,33



900204
Tuvalet Kağıtlık
Toilet Roll Holder

PRICE
18,56



900205
Kapaklı Tuvalet Kağıtlık
Toilet Roll Holder With Lid

PRICE
23,22



900206
Kapaklı Havlu Kağıtlık
Towel Paper Holder With Lid

PRICE
24,56



900207
Tuvalet Kağıtlık
Toilet Roll Holder

PRICE
20,41



900208
Yedek Tuvalet Kağıtlık
Spare Roll Holder

PRICE
22,45

Hanya Serisi

Hanya Series



900209
Diş Fırçalık
Toothbrush Holder

PRICE
24,89



900210
Sabunluk
Soap Dish Holder

PRICE
24,89



900211
Tekli Askılık
Robe Hook

PRICE
15,11



900212
İkili Askılık
Double Robe Hook

PRICE
24,18



900213
Metal Sıvı Sabunluk
Soap Dispenser Metal

PRICE
54,76



900214
Cam Sıvı Sabunluk
Soap Dispenser Glass

PRICE
54,76



900215
İkili Havluluk
Double Towel Holder

PRICE
54,76



900216
Cam Klozet Fırçası
Toilet Brush Holder Glass

PRICE
49,78

Halley Serisi

Halley Series



9001000
Etajer
Glass Shelf

PRICE
34,20



9001001
Uzun Havluluk
Towel Bar

PRICE
42,17



9001002
Halka Havluluk
Towel Ring

PRICE
34,90



9001003
Havlu Kağıtlık
Towel Paper Holder

PRICE
26,00



9001004
Tuvalet Kağıtlık
Toilet Roll Holder

PRICE
20,61



9001005
Kapaklı Tuvalet Kağıtlık
Toilet Roll Holder With Lid

PRICE
23,19



9001006
Havluluk
Towel Holder

PRICE
26,38



9001007
Tuvalet Kağıtlık
Toilet Roll Holder

PRICE
23,43



9001009
İkili Askılık
Double Robe Hook

PRICE
18,51



9001010
Diş Fırçalık
Toothbrush Holder

PRICE
22,72



9001011
Sabunluk
Soap Dish Holder

PRICE
22,72



9001012
Cam Sıvı Sabunluk
Soap Dispenser Glass

PRICE
32,33



9001014
Klozet Fırçası
Toilet Brush Holder

PRICE
46,38

Antares Serisi

Antares Series



Etajer
Glass Shelf

PRICE

9001300	Krom / Chrome	24,44
9001300-1	Altın / Gold	26,67
9001300-2	Antik / Antique	26,67



Uzun Havluluk
Towel Bar

PRICE

9001301	Krom / Chrome	28,89
9001301-1	Altın / Gold	33,33
9001301-2	Antik / Antique	33,33



Halka Havluluk
Towel Ring

PRICE

9001302	Krom / Chrome	23,89
9001302-1	Altın / Gold	25,56
9001302-2	Antik / Antique	25,56



Açık Kağıtlık
Toilet Roll Holder

PRICE

9001303	Krom / Chrome	16,67
9001303-1	Altın / Gold	21,11
9001303-2	Antik / Antique	14,44



Kapaklı Tuvalet Kağıtlık
Toilet Roll Holder With Lid

PRICE

9001304	Krom / Chrome	17,78
9001304-1	Altın / Gold	25,56
9001304-2	Antik / Antique	26,11



Açık Kağıt Havluluk
Towel Paper Holder

PRICE

9001305	Krom / Chrome	17,78
9001305-1	Altın / Gold	22,22
9001305-2	Antik / Antique	22,22



Kapaklı Kağıt Havluluk
Towel Paper Holder With Lid

PRICE

9001306	Krom / Chrome	18,89
9001306-1	Altın / Gold	26,11
9001306-2	Antik / Antique	26,11



Rozetli Kare Süngerlik
Corner Basket

PRICE

9001307	Krom / Chrome	20,00
9001307-1	Altın / Gold	25,00
9001307-2	Antik / Antique	25,00



Kanca Askılık / 4'lü
Robe Hook / Quartet

PRICE

9001308	Krom / Chrome	26,67
9001308-1	Altın / Gold	32,22
9001308-2	Antik / Antique	32,22



İkili Askılık
Robe Hook

PRICE

9001309	Krom / Chrome	11,67
9001309-1	Altın / Gold	13,89
9001309-2	Antik / Antique	13,89



Diş Fırçalık
Toothbrush Holder

PRICE

9001310	Krom / Chrome	13,89
9001310-1	Altın / Gold	28,89
9001310-2	Antik / Antique	15,56



Sabunluk
Soap Dish Holder

PRICE

9001311	Krom / Chrome	13,89
9001311-1	Altın / Gold	15,56
9001311-2	Antik / Antique	15,56



Klozet Fırçası
Toilet Brush

PRICE

9001312	Krom / Chrome	26,67
9001312-1	Altın / Gold	28,89
9001312-2	Antik / Antique	28,89

Uranüs Serisi

Uranus Series



Krom / Chrome



Uzun Havluluk
Towel Bar

PRICE

900725 Krom/Chrome
900725-1 Siyah/Black

38,34
33,34



Kare Havluluk
Towel Holder

PRICE

900714 Krom/Chrome
900714-1 Siyah/Black

32,67
28,41



Tuvalet Kağıtlık
Toilet Roll Holder

PRICE

900713 Krom/Chrome
900713-1 Siyah/Black

24,64
21,43



Havlu Kağıtlık
Towel Paper Holder

PRICE

900726 Krom/Chrome
900726-1 Siyah/Black

29,35
25,52



Tuvalet Kağıtlık
Toilet Roll Holder

PRICE

900727 Krom/Chrome
900727-1 Siyah/Black

24,64
21,43



İkili Askılık
Double Robe Hook

PRICE

900719 Krom/Chrome
900719-1 Siyah/Black

17,44
15,17

Orion Serisi

Orion Series



9001901
Etajer
Glass Shelf

PRICE
24,54



9001900
Uzun Havluluk
Towel Bar

PRICE
20,54



9001902
Tuvalet Kağıtlık
Toilet Roll Holder

PRICE
12,89



9001903
Kapaklı Tuvalet Kağıtlık
Toilet Roll Holder With Lid

PRICE
17,26



9001906
Havlu Kağıtlık
Towel Paper Holder

PRICE
14,86



9001907
Havluluk
Towel Holder

PRICE
14,42



9001904
Çok Amaçlı Tuvalet Kağıtlık
Toilet Roll Holder With Mobile Phone Pad

PRICE
12,67



9001909
İkili Askılık
Double Robe Hook

PRICE
11,80



9001910
Tekli Askılık
Single Robe Hook

PRICE
11,36

Perus 1 Serisi

Perus 1 Series



9002200
Uzun Havluluk
Towel Bar

PRICE
7,43



9002201
Halka Havluluk
Towel Ring

PRICE
5,46



9002202
Diş Fırçalık
Toothbrush Holder

PRICE
4,59



9002203
Sabunluk
Soap Dish Holder

PRICE
4,59



9002204
Tuvalet Kağıtlık
Toilet Roll Holder

PRICE
4,81



9002205
Kapaklı Tuvalet Kağıtlık
With Lid Toilet Roll Holder

PRICE
5,68



9002206
Havlu Kağıtlık
Towel Paper Holder

PRICE
5,03



9002207
Kapaklı Havlu Kağıtlık
Towel Paper Holder With Lid

PRICE
6,77



9002208
İkili Askılık
Double Robe Hook

PRICE
4,81



9002209
İkili Askılık
Double Robe Hook

PRICE
3,93



9002210
İkili Askılık
Double Robe Hook

PRICE
4,37



9002211
Üçlü Askılık
Triple Robe Hook

PRICE
8,74

Perus 2 Serisi

Perus 2 Series



9002300
Uzun Havluluk
Towel Bar

PRICE
7,41



9002301
Halka Havluluk
Towel Ring

PRICE
5,93



9002302
Diş Fırçalık
Toothbrush Holder

PRICE
4,59



9002303
Sabunluk
Soap Dish Holder

PRICE
4,59



9002304
Tuvalet Kağıtlık
Toilet Roll Holder

PRICE
4,81



9002305
Kapaklı Tuvalet Kağıtlık
With Lid Toilet Roll Holder

PRICE
6,11



9002306
Havlu Kağıtlık
Towel Paper Holder

PRICE
5,56



9002307
Kapaklı Havlu Kağıtlık
Towel Paper Holder With Lid

PRICE
6,99



9002308
İkili Askılık
Double Robe Hook

PRICE
4,81



9002309
İkili Askılık
Double Robe Hook

PRICE
3,93



9002310
İkili Askılık
Double Robe Hook

PRICE
4,37



9002311
Üçlü Askılık
Triple Robe Hook

PRICE
9,07

Perus 3 Serisi

Perus 3 Series



9002400
Uzun Havluluk
Towel Bar

PRICE
8,15



9002401
Halka Havluluk
Ring Towel Holder

PRICE
6,30



9002402
Havlu Kağıtlık
Towel Paper Holder

PRICE
5,68



9002403
Kapaklı Havlu Kağıtlık
With Lid Towel Paper Holder

PRICE
7,43



9002404
Tuvalet Kağıtlık
Toilet Roll Holder

PRICE
5,24



9002405
Kapaklı Tuvalet Kağıtlık
With Lid Toilet Roll Holder

PRICE
6,12



9002406
Sabunluk
Soap Dish Holder

PRICE
5,03



9002407
Diş Fırçalık
Toothbrush Holder

PRICE
5,03



9002408
İkili Askılık
Double Robe Hook

PRICE
4,81



9002409
İkili Askılık
Double Robe Hook

PRICE
4,37



9002410
İkili Askılık
Double Robe Hook

PRICE
5,24



9002411
Üçlü Askılık
Triple Robe Hook

PRICE
9,61

Neptün Serisi

Neptun Series



900801
Etajer
Glass Shelf

PRICE
17,43



Muhafazalı Etajer
Glass Shelf with Guard

PRICE

900802 Neptün
900802P Neptün Premium

26,14
31,37



900803
Muhafazalı Etajer Lamalı
Glass Shelf with Guard

PRICE
38,34



900804
Uzun Havluluk / 30cm
Towel Bar

PRICE
14,25



Uzun Havluluk / 45cm
Towel Bar

PRICE

900805 Neptün
900805P Neptün Premium

15,83
19,00



Halka Havluluk
Towel Ring

PRICE

900806 Neptün
900806P Neptün Premium

10,36
12,44



Tuvalet Kağıtlık
Toilet Roll Holder

PRICE
9,79



Kapaklı Tuvalet Kağıtlık
Toilet Roll Holder With Lid

PRICE

900817 Neptün
900817P Neptün Premium

13,89
16,67



900809
Havlu Kağıtlık
Towel Paper Holder

PRICE
11,39



900810
Kapaklı Havlu Kağıtlık
Towel Paper Holder With Lid

PRICE
15,26



Kapaklı Tuvalet Kağıtlık Bekletmeli
Toilet Roll Holder with Spare Roll Holder

PRICE

900818 Neptün
900818P Neptün Premium

24,26
29,11



Yedek Kağıtlık Bekletme
Spare Toilet Roll Holder

PRICE
17,08
20,50

900824 Neptün
900824P Neptün Premium



900808
İkili Döner Havluluk
Towel Rail Swivel

PRICE
37,01

Neptün Serisi

Neptun Series



Sabunluk
Soap Dish Holder

900811 Neptün

900811P Neptün Premium

PRICE

13,21

15,85



Diş Fırçalık
Toothbrush Holder

900815 Neptün

900815P Neptün Premium

PRICE

13,21

15,85



900814
Cam Sıvı Sabunluk
Glass Liquid Soap Dispenser

PRICE

19,16



900813
Metal Sıvı Sabunluk
Metal Liquid Soap Dispenser

PRICE

29,00



900819
Tekli Hijyen Askılık
Single Hook Hygiene

PRICE

7,70



900820
İkili Hijyen Askılık
Double Hook Hygiene

PRICE

8,48



900821
Üçlü Hijyen Askılık
Triple Hook Hygiene

PRICE

9,32



İkili Askılık
Double Robe Hook

PRICE

900822 Neptün

900822P Neptün Premium

8,12

9,74



Tekli Askılık
Single Robe Hook

PRICE

900823 Neptün

900823P Neptün Premium

7,00

8,41



900807
Üçlü Askılık
Robe Hanger With 3 Hooks

PRICE

20,30



900825
Cam Klozet Fırçası
Glass Toilet Brush Holder

PRICE

26,42



900826
Metal Klozet Fırçası
Metal Toilet Brush Holder

PRICE

29,86

Mars Serisi

Mars Series



Etajer
Glass Shelf
900901 Mars 20,22
900901P Mars Premium 24,26

PRICE

20,22

24,26



Uzun Havluluk
Towel Bar
900902 Mars 19,25
900902P Mars Premium 23,10

PRICE

19,25

23,10



Halka Havluluk
Towel Ring
900903 Mars 11,96
900903P Mars Premium 14,35

PRICE

11,96

14,35



900904
Kapaklı Havlu Kağıtlık
Towel Paper Holder With Lid
PRICE 16,86

PRICE

16,86



900905
Kağıt Havluluk
Towel Paper Holder
PRICE 13,67

PRICE

13,67



900906
İkili Döner Havluluk
Towel Rail Swivel
PRICE 38,95

PRICE

38,95



Kapaklı Tuvalet Kağıtlık
Toilet Roll Holder With Lid
900907 Mars 15,94
900907P Mars Premium 19,13

PRICE

15,94

19,13



Yedek Kağıtlık Bekletme
Spare Toilet Roll Holder
900908 Mars 17,77
900908P Mars Premium 21,32

PRICE

17,77

21,32



Sabunluk
Soap Dish Holder
900909 Mars 14,24
900909P Mars Premium 17,08

PRICE

14,24

17,08



Diş Fırçalık
Toothbrush Holder
900910 Mars 14,24
900910P Mars Premium 17,08

PRICE

14,24

17,08



Tekli Askılık
Single Robe Hook
900911 Mars 8,31
900911P Mars Premium 9,98

PRICE

8,31

9,98



İkili Askılık
Double Robe Hook
900912 Mars 10,16
900912P Mars Premium 12,19

PRICE

10,16

12,19



900913
İkili Hijyen Askılık
Double Hook Hygiene
PRICE 11,68

PRICE

11,68

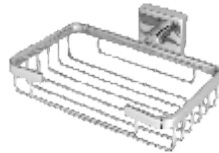

900914
Rozetli Süngerlik Büyük
Sponge Holder
PRICE 19,13

PRICE

19,13



900915
Cam Klozet Fırçası
Glass Toilet Brush Holder
PRICE 24,87

PRICE

24,87

Eko Serisi

Eco Series



914451
Etajer
Glass Shelf

PRICE
5,06



914456
Uzun Havluluk
Towel Bar

PRICE
4,69



914457
Halka Havluluk
Towel Ring

PRICE
3,55



914454
Tuvalet Kağıtlık
Toilet Roll Holder

PRICE
3,37



914455
Dar Kapaklı Tuvalet Kağıtlık
Toilet Roll Holder With Lid

PRICE
3,85



914458
Geniş Kapaklı Tuvalet Kağıtlık
Toilet Roll Holder With Lid

PRICE
4,09



914460
Havlu Kağıtlık
Towel Paper Holder

PRICE
3,61



914461
Dar Kapaklı Havlu Kağıtlık
Towel Paper Holder With Lid

PRICE
4,09



914462
Geniş Kapaklı Havlu Kağıtlık
Towel Paper Holder With Lid

PRICE
4,33



914453
Diş Fırçalık
Toothbrush Holder

PRICE
3,61



914452
Sabunluk
Soap Dish Holder

PRICE
3,61



914469
İkili Askılık
Double Robe Hook

PRICE
2,65



914468
İkili Askılık
Double Robe Hook

PRICE
2,65

Eko Serisi

Eco Series



912451
Etajer
Glass Shelf

PRICE
5,06



912456
Uzun Havluluk
Towel Bar

PRICE
4,69



912457
Havluluk
Towel Ring

PRICE
3,55



912454
Tuvalet Kağıtlık
Toilet Roll Holder

PRICE
3,37



912455
Dar Kapaklı Tuvalet Kağıtlık
Toilet Roll Holder With Lid

PRICE
3,85



912458
Geniş Kapaklı Tuvalet Kağıtlık
Toilet Roll Holder With Lid

PRICE
4,09



912460
Havlu Kağıtlık
Towel Paper Holder

PRICE
3,61



912461
Dar Kapaklı Havlu Kağıtlık
Towel Paper Holder With Lid

PRICE
4,09



912462
Geniş Kapaklı Havlu Kağıtlık
Towel Paper Holder With Lid

PRICE
4,33



912453
Diş Fırçalık
Toothbrush Holder

PRICE
3,61



912452
Sabunluk
Soap Dish Holder

PRICE
3,61



912469
İkili Askılık
Double Robe Hook

PRICE
2,65



912468
İkili Askılık
Double Robe Hook

PRICE
2,65

Eko Siyah D Serisi

Eco Black D Series



9002100
Etajer
Glass Shelf

PRICE
6,62



9002101
Uzun Havluluk
Towel Bar

PRICE
6,74



9002102
Halka Havluluk
Towel Ring

PRICE
4,94



9002103
Havlu Kağıtlık
Towel Paper Holder

PRICE
5,06



9002104
Kapaklı Havlu Kağıtlık
Towel Paper Holder With Lid

PRICE
6,38



9002105
Kapaklı Havlu Kağıtlık
Towel Paper Holder With Lid

PRICE
6,86



9002106
Tuvalet Kağıtlık
Toilet Roll Holder

PRICE
4,69



9002107
Dar Kapaklı Tuvalet Kağıtlık
Toilet Roll Holder With Lid

PRICE
6,02



9002108
Geniş Kapaklı Tuvalet Kağıtlık
Toilet Roll Holder With Lid

PRICE
6,50



9002109
Sabunluk
Soap Dish Holder

PRICE
5,06



9002110
Diş Fırçalık
Toothbrush Holder

PRICE
5,06



9002111
İkili Askılık
Double Robe Hook

PRICE
3,61



9002112
İkili Askılık
Double Robe Hook

PRICE
3,61



9002113
Üçlü Askılık
Triple Robe Hook

PRICE
3,61



9002114
Klozet Fırçası
Toilet Brush

PRICE
9,03

Eko Black Serisi

Eco Black Series



9002000
Uzun Havluluk
Towel Bar

PRICE
6,74



9002001
Halka Havluluk
Ring Towel Holder

PRICE
4,94



9002002
Havlu Kağıtlık
Towel Paper Holder

PRICE
5,06



9002003
Kapaklı Havlu Kağıtlık
Towel Paper Holder With Lid

PRICE
6,86



9002004
Sabunluk
Soap Dish Holder

PRICE
5,06



9002005
Tuvalet Kağıtlık
Toilet Roll Holder

PRICE
4,69



9002006
Kapaklı Tuvalet Kağıtlık
Toilet Roll Holder With Lid

PRICE
6,50



9002007
Diş Fırçalık
Toothbrush Holder

PRICE
5,06



9002008
İkili Askılık
Double Robe Hook

PRICE
3,61



9002009
Üçlü Askılık
Triple Robe Hook

PRICE
5,06

Şampuanlıklar Shower Caddies



Kalın Lamalı Lüks Süngerlik
Corner Basket
22x11 cm
911610 Krom / Chrome

PRICE
83,56



Kalın Lamalı Köşe Süngerlik
Corner Basket
22x13,5 cm

911611 Krom / Chrome

PRICE
91,91



Kalın Lamalı Derin Köşe Süngerlik
Corner Basket
27,5x13,5 cm

911612

PRICE
101,10



901014-12
Üçgen Derin Model Tekli Levha Süngerlik
Corner Basket
18.5x18.5 cm

PRICE
26,03

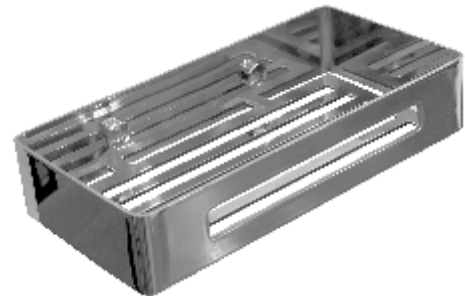

901020-7
Tekli Derin Dikdörtgen Levha Süngerlik
Corner Basket
20x10 cm

PRICE
26,03

Şampuanlıklar

Shower Caddies

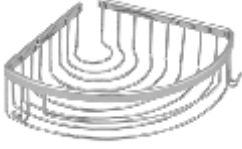

Oval Dalgalı Tekli Süngerlik
Corner Basket / Single

PRICE

901003 18x18 cm
912971 22x22 cm

19,71
23,67



Oval Dalgalı İkili Süngerlik
Corner Basket / Double

PRICE

901004 18x18 cm
912972 22x22 cm

41,78
50,89



Oval Dalgalı Üçlü Süngerlik
Corner Basket / Triple

PRICE

901005 18x18 cm
912973 22x22 cm

64,78
78,00



Tekli Köşe Süngerlik
Corner Basket / Single

PRICE

901006 15x15cm
901014 18x18cm
901015 22x22cm

14,84
16,44
20,22



İkili Köşe Süngerlik
Corner Basket / Double

PRICE

901007 15x15cm
901016 18x18cm
901017 22x22cm

32,56
36,00
43,11



Üçlü Köşe Süngerlik
Corner Basket / Triple

PRICE

901008 15x15cm
901018 18x18cm
901019 22x22cm

50,33
53,44
65,67



Tekli Oval Süngerlik
Corner Basket Single

PRICE

901003-2 18x18 cm
912771 22x22 cm

19,71
23,67



İkili Oval Süngerlik
Corner Basket Double

PRICE

901004-2 18x18 cm
912772 22x22 cm

41,78
50,89



Üçlü Oval Süngerlik
Corner Basket Triple

PRICE

901005-2 18x18 cm
912773 22x22 cm

64,78
78,00

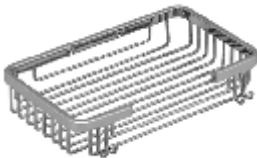

Tekli Kare Süngerlik
Square Corner Basket / Single

PRICE

901009 22x15cm

18,89



İkili Kare Süngerlik
Square Corner Basket / Double

PRICE

901010 22x15cm

40,00



Üçlü Kare Süngerlik
Square Corner Basket / Triple

PRICE

901112 22x15cm

58,89

Şampuanlıklar

Shower Caddies



911621
Süngerlik
Basket
20x10 cm

PRICE
18,79



911623
Rozetli Süngerlik
Basket
20x10 cm

PRICE
20,82



911622
Rozetli Süngerlik
Basket
20x10 cm

PRICE
21,76



911609
Dikdörtgen Rozetli Süngerlik
Basket
20x10 cm

PRICE
18,79



911608
Dikdörtgen Süngerlik
Basket
20x10 cm

PRICE
18,79



911630
Kare Tel Süngerlik
Basket

11x8 cm

PRICE
12,44



911632
Rozetli Kare Tel Süngerlik
Basket
11x12 cm

PRICE

19,78



911626
Oval Tel Süngerlik
Basket
15x8 cm

PRICE

12,44



911628
Oval Rozetli Tel Süngerlik
Basket
15x12 cm

PRICE

19,78

Şampuanlıklar

304K Shower Caddies



Tekli Süngerlik / Siyah
Corner Basket / Single / Black
901003-5-1 18x18cm **PRICE** 16,40



İkili Süngerlik / Siyah
Corner Basket / Double / Black
901017-5-1 18x18cm **PRICE** 31,09



Üçlü Süngerlik / Siyah
Corner Basket / Triple / Black
901017-6-1 18x18cm **PRICE** 42,38



Oval Dalgalı Tekli Süngerlik
Corner Basket / Single
901003-5 18x18 cm **PRICE** 13,20



Oval Dalgalı İkili Süngerlik
Corner Basket / Double
901017-5 18x18 cm **PRICE** 24,70



Oval Dalgalı Üçlü Süngerlik
Corner Basket / Triple
901017-6 18x18 cm **PRICE** 32,80



Tekli Köşe Süngerlik
Corner Basket / Single
901003-5-2 20x20cm **PRICE** 19,17



İkili Köşe Süngerlik
Corner Basket / Double
901017-5-2 20x20cm **PRICE** 41,53



Üçlü Köşe Süngerlik
Corner Basket / Triple
901017-6-2 20x20cm **PRICE** 53,24



İkili Kare Süngerlik
Square Corner Basket / Single
901003-5-3 15x25cm **PRICE** 15,97



İkili Kare Süngerlik
Square Corner Basket / Double
901017-5-3 15x25cm **PRICE** 31,73



Üçlü Kare Süngerlik
Square Corner Basket / Triple
901017-6-3 15x25cm **PRICE** 37,91

Makyaj Aynaları

Make-Up Mirrors



PRICE
54,00

901029
Duvara Monte Makyaj Aynası - Çift Taraflı /
Make-Up Mirror - Two Sided



PRICE
54,00

901030
Duvara Monte Makyaj Aynası - Çift Taraflı /
Make-Up Mirror - Two Sided



PRICE
66,49

901022
Ayaklı Makyaj Aynası /
Free Stand Make-Up Mirror

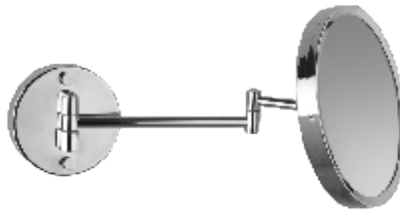

PRICE
72,00

901028
Duvara Monte Arkadan Mafsallı
Makyaj Aynası /
Make-Up Mirror



PRICE
88,89

901025
Duvara Monte Arkadan Mafsallı
Makyaj Aynası / Ledli
Make-Up Mirror with Led



PRICE
168,89

901031
Duvara Monte Makyaj Aynası / Ledli
Make-Up Mirror with Led



PRICE
120,89

901033
Duvara Monte Makyaj Aynası / Ledli
Make-Up Mirror with Led

Ayaklı Setler

Freestands Series



901046
PRICE
188,22



901047
PRICE
188,22

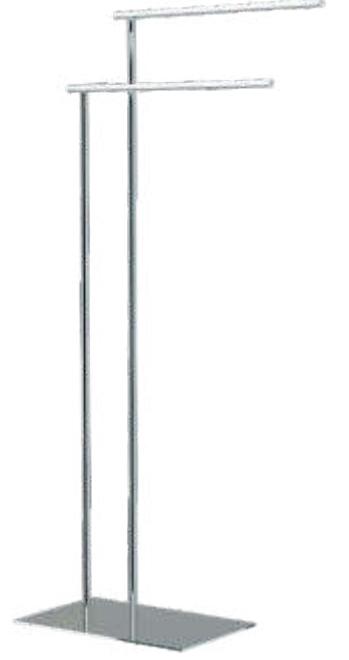

901052
PRICE
174,78

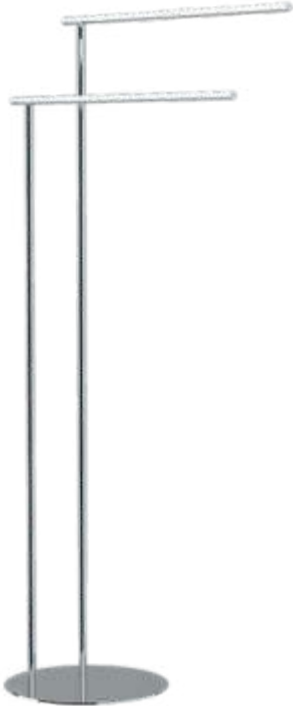

901053
PRICE
174,78



901054
PRICE
134,44

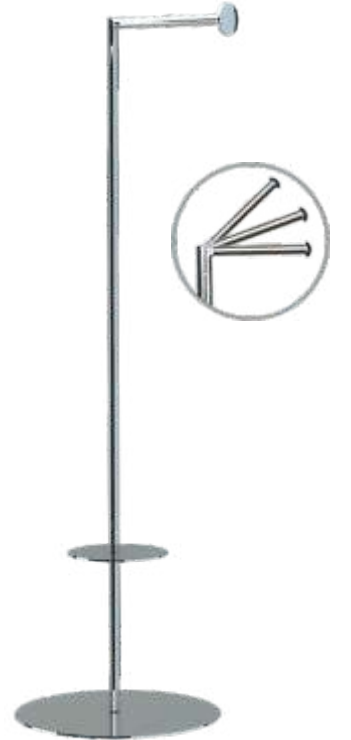

901055
PRICE
134,44

Ayaklı Setler

Freestands Series



PRICE

901048	Krom / Chrome	343,47
901048-1	Altın / Gold	613,20
901048-2	Antik / Antique	445,20



PRICE

901049	Krom / Chrome	279,07
901049-1	Altın / Gold	382,85
901049-2	Antik / Antique	331,33



PRICE

901050	Krom / Chrome	454,53
901050-1	Altın / Gold	692,53
901050-2	Antik / Antique	546,00



901044-11

PRICE

46,11



901044-7

PRICE

46,11



901044

PRICE

46,82

Fotoselli Ürünler

Photocell Products



925500
Fotoselli Batarya
Photocell Faucet

PRICE
217,22



925501
Fotoselli Batarya
Photocell Faucet

PRICE
198,06



925502
Fotoselli Batarya
Photocell Faucet

PRICE
210,83



925503
Fotoselli Batarya
Photocell Faucet

PRICE
204,44

FOTOSELLİ BATARYA TEKNİK ÖZELLİKLERİ PHOTOCELL FAUCET SPECIFICATION

Güç Kaynağı Power Supply	AC220V(50/60Hz) DC6V(4AA alkalın pil)
Statik Durumda Güç Tüketimi Power Consumption	<0.5mw
Algılama Mesafesi Detection Distance	12-18 cm
Su Basıncı Water Pressure	5-6 Bar
Çevre Sıcaklığı Env. Temperature	0.1-45C
Su Sıcaklığı Water Temperature	0-80C
Giriş - Çıkış Boru Çapı Inlet - Outlet Pipe Diameter	G1/2"(DN15)



925504
Fotoselli Batarya
Photocell Faucet

PRICE
223,61



925505
Fotoselli Batarya
Photocell Faucet

PRICE
287,50



925506
Fotoselli Batarya
Photocell Faucet

PRICE
204,44



925507
PRICE
204,44



925508
PRICE
207,64



925509
PRICE
207,64

FOTOSELLİ PİŞUVAR TEKNİK ÖZELLİKLERİ PHOTOCELL URINAL SPECIFICATION

Güç Kaynağı Power Supply	AC220V50/60Hz DC6V/AC220V alternatif
Statik Durumda Güç Tüketimi Power Consumption	5W 220V altında aktığında <0.5mW
Algılama Mesafesi Detection Distance	40-70cm
Su Basıncı Water Pressure	5-6 Bar
Çevre Sıcaklığı Env. Temperature	0.1-45C
Ağızlık Çapı Diameter	G1/2"(DN15)

Fotoselli Ürünler

Photocell Products



241300

El Kurutma Makinası
Hand Dryer
2500 Watt

PRICE
285,19



241300-1

El Kurutma Makinası
Hand Dryer
2000 Watt

PRICE
107,96



302322

Sıvı Sabun Makinası
Soap Dispenser
800 ml

PRICE
290,28



302323-2

Sıvı Sabun Makinası
Soap Dispenser
800 ml

PRICE
198,61



302323-3

Sıvı Sabun Makinası
Soap Dispenser
1100 ml

PRICE
229,17



302323

Sıvı Sabun Makinası
Soap Dispenser
1100 ml

PRICE
94,44

Paslanmaz Çelik Bakımı

Paslanmaz çelik'in en önemli iki elementi Krom ve Nikel'dir. Paslanmaz çelik parlaklığını kromdan ve paslanmazlık özelliğinden nikelden alır. Paslanmaz çelik, yapı olarak pas tutmaya eğilim gösterdiği durumlar vardır, bu ancak metaller ile uzun süre temas halinde ortaya çıkabilir.

Paslanmaz çelik ürünlerinizi doğru bakım uygulayarak çok daha uzun ömürlü yapabilirsiniz. Ürünlerinizi dikkatli kullanırsanız, paslanmaz çelik kalitesini ve görünümünü devamlı koruyabilirsiniz.

• Paslanmaz Çelik Ürünün Temizlenmesi

Günlük bakım için, sadece temiz suyla veya ıslak bez ile temizlenmesini tavsiye ederiz. Yüzeydeki toz, kurumuş lekeler, yiyecek ve içecek kalıntıları ile benzeri kirlilik yaratan artıkları ıslak bir bez ile temizlenmeli.

Kurumuş yağ lekeleri için bulaşık deterjanı da kullanılabilir. Temizleme işleminden sonra yüzey tamamen kurulanmalıdır. Bulaşık deterjanı çamasır suyu içermemelidir, örn. Cif.

• Kimyasal Maddelerden Dolayı Olusan Lekeler

Ürün güçlü kimyasallar ile temas halinde zarar görür. Yüzey kimyasal maddeler ile uzun süre temas halinde kalırsa, yüzeyde oksitlenmeler oluşabilir ve bu durumdan ötürü paslanma başlayabilir.

Paslanmaz çelik ile temasta bulunulmaması gereken bazı kimyasal ürünler başlıca şunlardır: S-39 solder ux, boya çıkarıcılar, fırça temizleyicileri, metal kazıcılar ve yapıştırıcılar.

Ürünün yukarıda belirtilen herhangi bir kimyasal ile teması halinde, aşağıdaki önlemlere başvurulabilir:

- Etkilenen yüzeyi temiz suyla bolca temizleyiniz;
- Etkilenen yüzeyi kuruyunuz;
- Paslanmaz çelik koruyucuları kullanınız;

Temizleme suyu kireçli ise yüzeyde leke bırakabilir. Bunun için temizleme sırasında sert tanecikli ve lif yapıda olmayan bir bez kullanılmalıdır.

Paslanmaz ürünün yüzeyindeki kalan parmak izleri için de cam yüzeyleri temizlemek için kullanılan sıvı temizleyicilerinden faydalanılabilir.

Maintenance for Stainless Steel Products

Stainless steel is a metal alloy, the most important elements of which are chrome and nickel. Stainless steel gets its lustre from the chrome and its stainless quality from the nickel. Stainless steel may be prone to surface rust, but only as a result of prolonged contact with base metals.

Adhering to the maintenance tips will ensure that you enjoy your product for even longer. If you handle your product with care, it will retain its quality and appearance for much longer.

Cleaning your stainless steel product

For everyday maintenance we advise using clean water or a wet cloth only. The product's surface must be cleaned with a wet cloth for dust, dried stains, and food and beverages residues.

Dish liquid soap may be used to clean the surface from dried grease stains. Afterwards the surface must be fully dried. Please note dish liquid must not contain bleach, such as Cif.

Stains caused by chemical substances

The quality of the product will be damaged if it is exposed to harsh chemicals. If the surface is exposed to harsh chemicals for a long period of time an oxidization process may occur, which will cause the stainless steel to rust.

You are advised to prevent the product from coming into contact with the following chemicals: S-39 solder ux, paint stripping agents, brush cleaners, metal shavings, and adhesives.

Should the product come into contact with one of the above-mentioned chemicals, the following action should be taken:

- Rinse the affected surface immediately using plenty of water;
- Rub the affected surface dry;
- Treat the resulting stains with Inox Care;

If the cleaning water is calcareous, there may be some spots left on the surface. It will be sufficient to use of a non-rigid particulate and brous structure cloth.

If there are finger prints on the stainless steel products surface, liquid window cleaner can be used.

• Copyright ©2019 Tüm Hakları Saklıdır. Kısmen veya tamamen kopyalanamaz.

• Noksi Metal, tüm ürünlerinde önceden haber vermeksizin değişiklik yapma hakkına sahiptir.

• Bu katalogta basılan renkler ofset renkler ile görüntülenebilmistir. Katalogdaki renkler ile ürün renkleri arasında ton farkı olabilir.

• Doğru renkleri görmek için numuneye bakınız.

Noksi Metal San. ve Dış. Tic. Ltd. Şti.

Fatih Mah. Emirhan Sk. No:1 Samandıra,
Sancaktepe, İstanbul Pk: 34885

T: +90 (216) 314 03 30 - 31

F: +90 (216) 314 03 02

Fabrika Satış Mağazası

İstoç Ticaret Merkezi, 2433 Sk. 15 Ada
No:32 İstoç, Bağcılar, İstanbul

T: +90 (212) 659 5 658

www.noksi.com.tr - info@noksi.com.tr