



formül®



Made in
Turkey

**PRODUCT
CATALOGUE**



Formül produces PP-R pipes and fittings, PVC pipes and fittings and PE-RT pipes, as well as metal inserts for its PP-R fittings.

In order to meet the needs of the plastic sector **Formül** started its production adventure as a **plastic industry mold producer** in the **early 1990's** when it was founded.

Formül has recently made major innovations and breakthroughs, one of the which is to move to its **privately-owned brand-new plant premises.**

Boasting a privileged location in the **Çerkezköy / Tekirdağ** industrial zone, all of the systems and facilities of the new plant premises covering approximately **40,000 sqm** were built in such a modern fashion as to compel **European standards.**

All of the fitting moulds were replaced with the **multispan moulds.**

Formül meets-up the metal and insert requirements of its **valves and all metal fittings** with production from its own facility which are manufactured with **fully automatic machines** in **Çerkezköy.** Completing its investments in the field of "Machining" with its modern tools and machines and **shaping metal as well as plastic,** **Formül** is one of the rare companies that **produce its own metal needs.**

Formül is now **leading** the field in the **PPRC industry** thanks to its **product range, capacity and excellent and impeccable quality.**





The World's Preference,
Turkey's Brand

formül[®]



Quality System Management



Our company, which is located in **Istanbul Turkey** is a major manufacturer and exporter of **PP-R pipes and fittings** for cold and hot water supply systems.

Our company was established in **1990** for the purpose of **mold construction and manufacturing**. In course of time, having several years of experience and expertise, has begun to produce also the **pipes and fittings** in **PP-R** and **PE-X** systems, and the **brass inserts** for the fittings. Step by step, following the developing technology, has reached currently to the **most extensive product range** in the sector.

We ensure our clients **high quality product, project-specific services and solutions** as well as successful organization, approved by the certificates

ISO 9000, CE, TSE, DVGW, SKZ, TZW, AENOR, AEO, GOST-R, CSTB, Ukr-SEPRO and other national certificates.

Becoming **leader company** in its field, several projects and works have been successfully completed by **professional staff** in our laboratory and by collaboration of different universities. As a result of this work, our company is among few companies in the sector with **patents, utility models and model certificates**, including giving **know-how** service to the new investors.

Our products have become a popular and requested brand in **Africa, CIS countries, Far and Middle East** within short time. We are proud of exporting our products to more than **80 countries** as a result of **accumulation of experience, using latest technology, environment friendly systems** and meeting the **customer expectations**.

Our highly qualified and well experienced team will be **happy to serve you...**





Fields of Application

Formül PP-R pipes and fittings are commonly used for hot and cold water systems.

Formül PP-R pipes and fittings can be directly used drinking water systems, wall, floor and radiator heating systems, air conditioning systems and transferring any kind of liquid systems.



formül[®]
PP-R, PVC PIPES and FITTINGS

World-wide



formul.com.tr

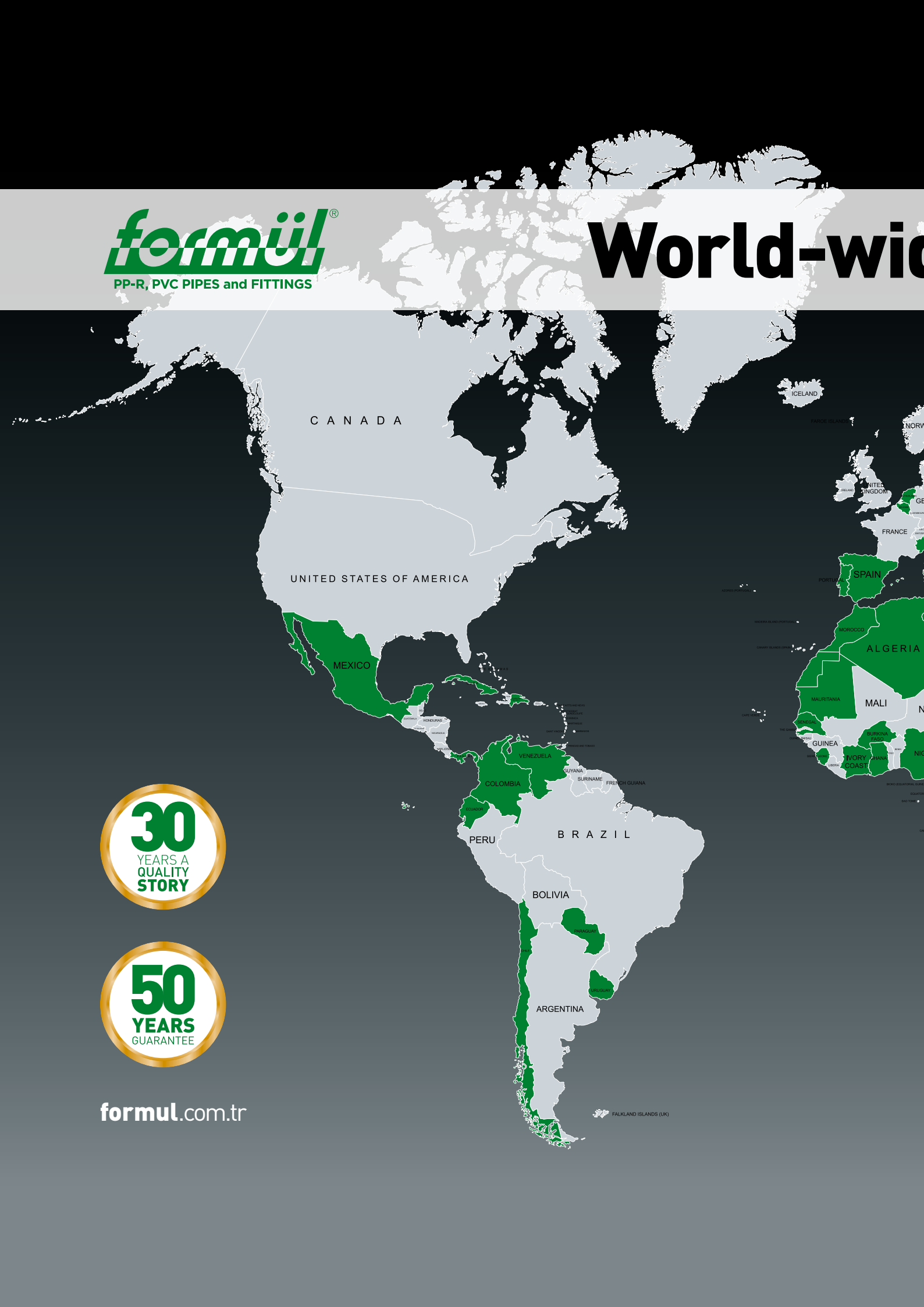

de Service

more than **80** Countries in **5** Continents

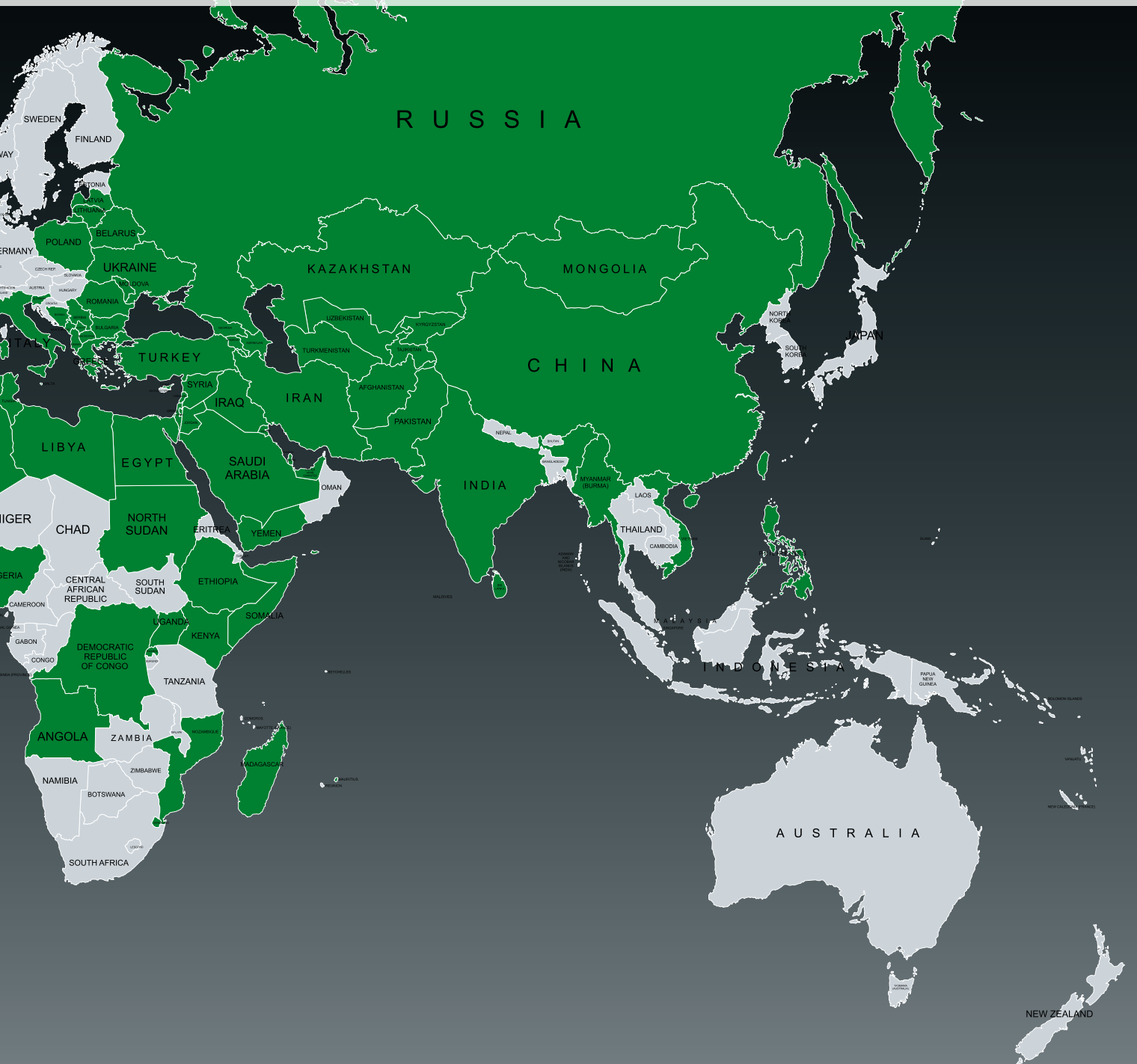



**First
Quality**



formül[®]

**TECHNICAL
INFORMATION**

1

Raw Material

Technical data

Polypropylene Random Copolymer (PP-R)

Pipe and fittings are produced using PP Random Copolymer (PP-R). PP Random Copolymer is commonly used in drinking water installations, hot water, floor and radiator heating systems and every kind of industrial liquid distribution systems.

PP-R has a lot of advantages over other plastics such as; long life duration, high resistance to pressure and heat, better flexibility, high acoustic and thermal insulation, high molecular weight, low MFI.

PP-R confirms the requirements of ASTM F 2389, DIN 8077, DIN 8078, EN ISO 15874 standards.

Technical Specifications

Characteristics		Unit	Test Method	Values
Density	+23°C	g/cm ³	ISO 1183	0,909
Melt Flow Index (MFI)	190 °C /5 kg	g/10 min	ISO 1133	0,4-0,6
	230°C /2,16 kg	g/10 min	ISO 1133	0,2-0,5
	230°C /5 kg	g/10 min	ISO 1133	0,8-1,3
Tensile Stress at yield (23°C)	(50 mm/min)	MPa	ISO 527	25
Tensile Strain at Yield	(50 mm/min)	%	ISO 527	10
Flexural Modules	+23°C	N/mm ²	ISO 527	800
Charpy Impact Strength (notched)	+23°C	kJ/m ²	ISO 179	>15
	0°C	kJ/m ²	ISO 179	>5
Charpy Impact Strength (unnotched)	0°C	kJ/m ²	ISO 179	No break
Vicat Softening Point	(1 kg)	°C	ASTM D 1525 ISO 306 DIN 53460	130
	(5 kg)	°C		60
Melting Range		°C	Polarizing Microscope	140-150
Linear Thermal Expansion Co-efficient		1/K	DIN 53752	1,5x10 ⁻⁴
Thermal Conductivity		W/mK	DIN 52612	0,24
Hardness (Shore D)	(3 sec value)		ISO 868	65
Pipe Friction Factor				0,007

Mechanical characteristics of tubular test pieces made of PP-R by injection moulding (TS EN ISO 15874-3)

Characteristic	Requirement	Test parameters for the individual tests PP-R					Test method
Resistance to Internal pressure	No failure during the test period	Hydrostatic Stress (Mpa)	Test Temp. (C°)	Test Period (h)	Number of test pieces	Test Pressure (Bar)	ISO 1167-1 ISO 1167-3
		16,0	20	1	3	53,1	
		3,5	95	1000	3	11,6	

Mechanical characteristics of pipes (TS EN ISO 15874-2)

Characteristic	Requirement	Test parameters for the individual tests PP-R					Test method
Resistance to internal pressure	No failure during the test period	Hydrostatic Stress (Mpa)	Test Temp. (C°)	Test Period (h)	Number of test pieces	Test Pressure (Bar)	ISO 1167-1 ISO 1167-2
		16,0	20	1	3	64	
		4,3	95	22	3	17,2	
		3.8	95	165	3	15,2	
		3,5	95	1000	3	14	

Physical and chemical characteristics of pipes (TS EN ISO 15874-2)

Characteristic	Requirement	Test parameters		Test method
		Parameter	Value	
Longitudinal reversion	≤ %2	Test temperature PP-R Duration of exposure for: en ≤ 8 mm 8mm ≤ en ≤ 16mm en > 16mm Number of test pieces	135 °C 1 h 2 h 4 h 3	Method B of ISO 2505 (oven test)
Thermal stability by hydrostatic pressure testing	No bursting during the test period	Test temperature Hydrostatic stress Test period Number of test pieces	110 °C 1,9 MPa 8760 h 1	ISO 1167-1 ISO 1167-2
Impact resistance	≤ %10	Test temperature Number of test pieces	0 °C 10	ISO 9854-1 ISO 9854-2
MFI (Raw material)	≤ 0,5g /10 min	Test temperature Mass Number of test pieces	230 °C 2,16 kg 3	ISO 1133-1
MFI (Pipe)	%30 maximum difference compared with compound from the same batch	Test temperature Mass Number of test pieces	230 °C 2,16 kg 3	

Pipe Dimension and Tolerances According to DIN 8077

SDR 11 (PN 10)

Outside Ø mm.	Tolerance mm.	Thickness mm.	Tolerance mm.	Inside Ø mm.	In" inches
20	+0.3/-0	1.9	+0.3/-0	16.20	1/2"
25	+0.3/-0	2.3	+0.4/-0	20.40	3/4"
32	+0.3/-0	2.9	+0.4/-0	26.20	1"
40	+0.4/-0	3.7	+0.5/-0	32.60	1 1/4"
50	+0.5/-0	4.6	+0.6/-0	40.80	1 1/2"
63	+0.6/-0	5.8	+0.7/-0	51.40	2"
75	+0.7/-0	6.8	+0.8/-0	61.40	2 1/2"
90	+0.9/-0	8.2	+1.0/-0	73.60	3"
110	+1.0/-0	10.0	+1.1/-0	90.00	4"
125	+1.2/-0	11.4	+1.3/-0	102.20	5"

SDR 7,4 (PN 16)

Outside Ø mm.	Tolerance mm.	Thickness mm.	Tolerance mm.	Inside Ø mm.	In" inches
20	+0.3/-0	2.8	+0.4/-0	14.00	1/2"
25	+0.3/-0	3.5	+0.5/-0	18.00	3/4"
32	+0.3/-0	4.4	+0.6/-0	23.20	1"
40	+0.4/-0	5.5	+0.7/-0	29.00	1 1/4"
50	+0.5/-0	6.9	+0.8/-0	36.20	1 1/2"
63	+0.6/-0	8.6	+1.0/-0	45.80	2"
75	+0.7/-0	10.3	+1.2/-0	54.40	2 1/2"
90	+0.9/-0	12.3	+1.4/-0	65.40	3"
110	+1.0/-0	15.1	+1.7/-0	79.80	4"
125	+1.2/-0	17.1	+1.9/-0	90.80	5"

SDR 6 (PN 20)

Outside Ø mm.	Tolerance mm.	Thickness mm.	Tolerance mm.	Inside Ø mm.	In" inches
20	+0.3/-0	3.4	+0.5/-0	13.20	1/2"
25	+0.3/-0	4.2	+0.6/-0	16.60	3/4"
32	+0.3/-0	5.4	+0.7/-0	21.20	1"
40	+0.4/-0	6.7	+0.8/-0	26.60	1 1/4"
50	+0.5/-0	8.3	+1.0/-0	33.40	1 1/2"
63	+0.6/-0	10.5	+1.2/-0	42.00	2"
75	+0.7/-0	12.5	+1.4/-0	50.00	2 1/2"
90	+0.9/-0	15.0	+1.7/-0	60.00	3"
110	+1.0/-0	18.3	+2.0/-0	73.40	4"
125	+1.2/-0	20.8	+2.2/-0	83.40	5"

Operating Life According to DIN 8077 (SF=1,5)

Temperature (C°)	Years of Service	PN10	PN16	PN20
		Pipe Series (S)		
		5	3,2	2,5
		Standart Dimension Ratio (SDR)		
		11	7,4	6
		Allowable Operating Pressure (Bar)		
10	1	17,5	27,8	35,1
	5	16,5	26,2	33,0
	10	16,1	25,6	32,2
	25	15,6	24,7	31,1
	50	15,2	24,1	30,3
20	1	15,0	23,7	29,9
	5	14,1	22,3	28,1
	10	13,7	21,7	27,4
	25	13,2	21,0	26,4
	50	12,9	20,4	25,7
30	1	12,7	20,2	25,4
	5	11,9	18,9	23,8
	10	11,6	18,4	23,2
	25	11,2	17,7	22,3
	50	10,9	17,2	21,7
40	1	10,8	17,1	21,6
	5	10,1	16,0	20,2
	10	9,8	15,5	19,6
	25	9,4	15,0	18,8
	50	9,2	14,5	18,3
50	1	9,1	14,5	18,2
	5	8,5	13,5	17,0
	10	8,2	13,1	16,5
	25	7,9	12,6	15,9
	50	7,7	12,2	15,4
60	1	7,7	12,2	15,4
	5	7,1	11,3	14,3
	10	6,9	11,0	13,9
	25	6,6	10,5	13,3
	50	6,4	10,2	12,9
70	1	6,5	10,3	12,9
	5	6,0	9,5	12,0
	10	5,8	9,2	11,6
	25	5,0	8,0	10,0
	50	4,2	6,7	8,5
80	1	5,4	8,6	10,8
	5	4,8	7,6	9,6
	10	4,0	6,4	8,1
	25	3,2	5,1	6,5
95	1	3,8	6,1	7,6
	5	2,6	4,1	5,2

Thermal Expansion in PP-R Pipes

PP-R pipes have an expansion coefficient that is much higher than the metal pipes. So, this characteristic should be taken into consideration during installations.

Calculation of thermal expansion is as follows:

$$\Delta L = L * \Delta T * \alpha$$

where

ΔT = The difference between environmental temperature and water temperature in Kelvin degrees (K) or Celsius (°C).

ΔL = Variation of length in mm.

L = Initial length of the pipe in m.

α = Coefficient of linear thermal expansion. The value of α is $1,5 * 10^{-4}$ (K-1) for PP-R pipes.

Pipe Length L (m.)	Linear Expansion ΔL (mm.)									
	Temperature Difference ΔL (°C)									
	10	20	30	40	50	60	70	80	90	100
1	1.5	3	4.5	6	7.5	8	10.5	12	13.5	15
2	3	6	9	12	15	18	21	24	27	30
3	4.5	9	13.5	18	22.5	27	21..5	36	40.5	45
4	6	12	18	24	30	36	42	48	54	60
5	7	15	22.5	30	37.5	45	52.5	60	67.5	75
6	9	18	27	36	45	54	63	72	81	90
7	10.5	21	31.5	42	52.5	63	73.5	84	94.5	105
8	12.5	24	36	48	60	72	84	96	108	120
9	13.5	27	40	54	67.5	81	94.5	108	121.5	135
10	15	30	45	60	75	90	105	120	135	150

Thermal Expansion of the Standart PP-R Pipe

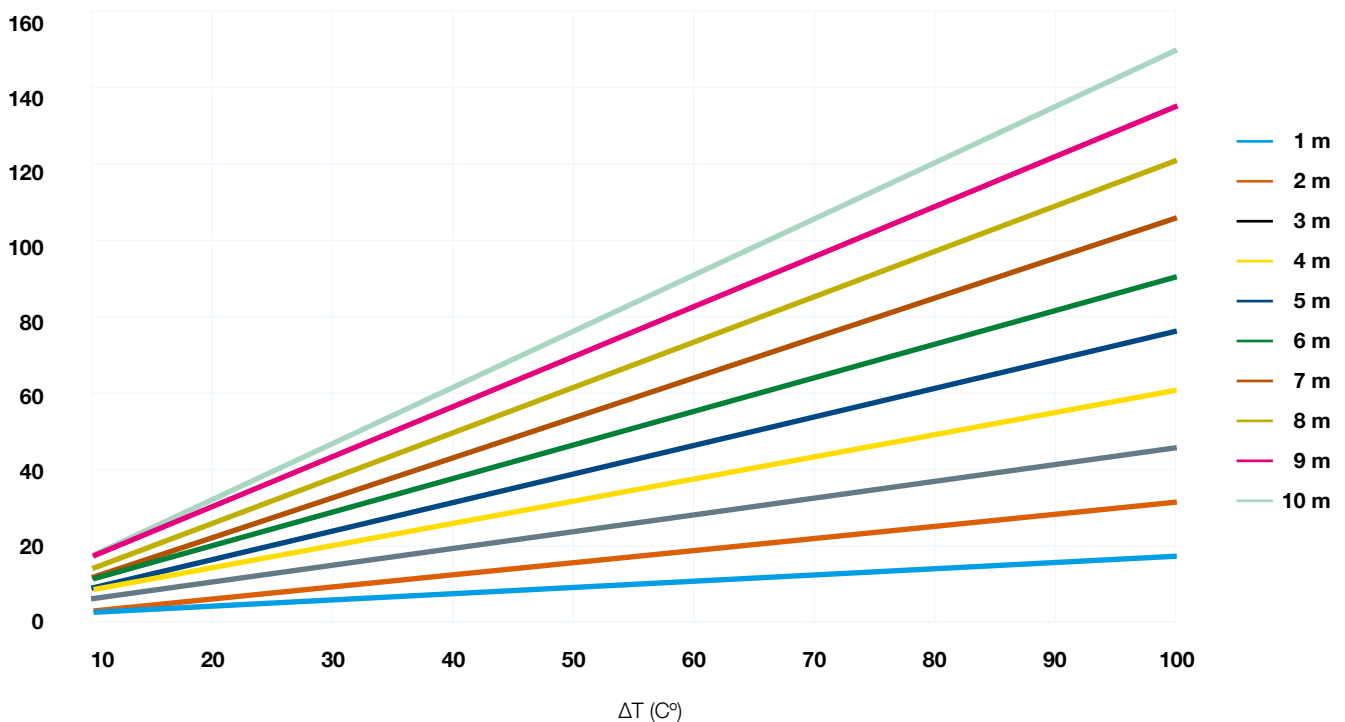

Example; at 70 °C for 8m PP-R pipe, $\Delta L=?$

$$\Delta L = L * \Delta T * \alpha$$

$$\Delta L = 8000 \text{ mm} * 70 * 0,00015$$

$$\Delta L = 84 \text{ mm}$$

PP-R Glassfiber Reinforced Pipe

PP-R Glassfiber Reinforced Pipe (PP-R/GF/PP-R) consist of three layers where the inner and outer layers are produced of PP-R and the middle layer is produced of the special mixture of PP-R and Glassfiber raw material.

Main Advantages of the PP-R Glassfiber Reinforced Pipe

- 1) Easier and faster installation since it does not require peeling before the welding operation.
- 2) It has 75 % less linear expansion than the standart PP-R pipe.
- 3) Higher stiffness than standart PP-R pipe.
- 4) Glassfiber PP-R pipes have thermal expansion co-efficient close to foil pipes, they can conveniently be used in the areas where foil pipes are used. Expansion co-efficient:
For Glassfiber Reinforced PP-R pipe: 0,035 mm/mK
For Aluminium Foil Reinforced PP-R Pipe: 0,030 mm/mK
For Standart PP-R Pipe: 0,15 mm/mK
- 5) Lighter than standart PP-R pipes.

Application Areas:

- 1) All kinds of hot and cold water installations.
- 2) Air pressure installations.
- 3) Heating installations and radiator connections.
- 4) Industry.

Thermal Expansion in Glassfiber Reinforced PP-R pipe

Calculation of Glassfiber Reinforced PP-R pipe thermal expansion is as follows:

$$\Delta L = L * \Delta T * \beta$$

where

ΔT = The difference between environmental temperature and water temperature in Kelvin degrees (K) or Celsius (°C).

ΔL = Variation of length in mm.

L = Initial length of the pipe in m.

ΔT = The difference between environmental temperature and water temperature in Kelvin degrees (K) or Celsius (°C).

β = Coefficient of linear thermal expansion. The value of β is $0,35 * 10^{-4}$ (K-1) for Glassfiber Reinforced PP-R pipes.

Thermal Expansion of the Glassfiber Reinforced PP-R Pipe

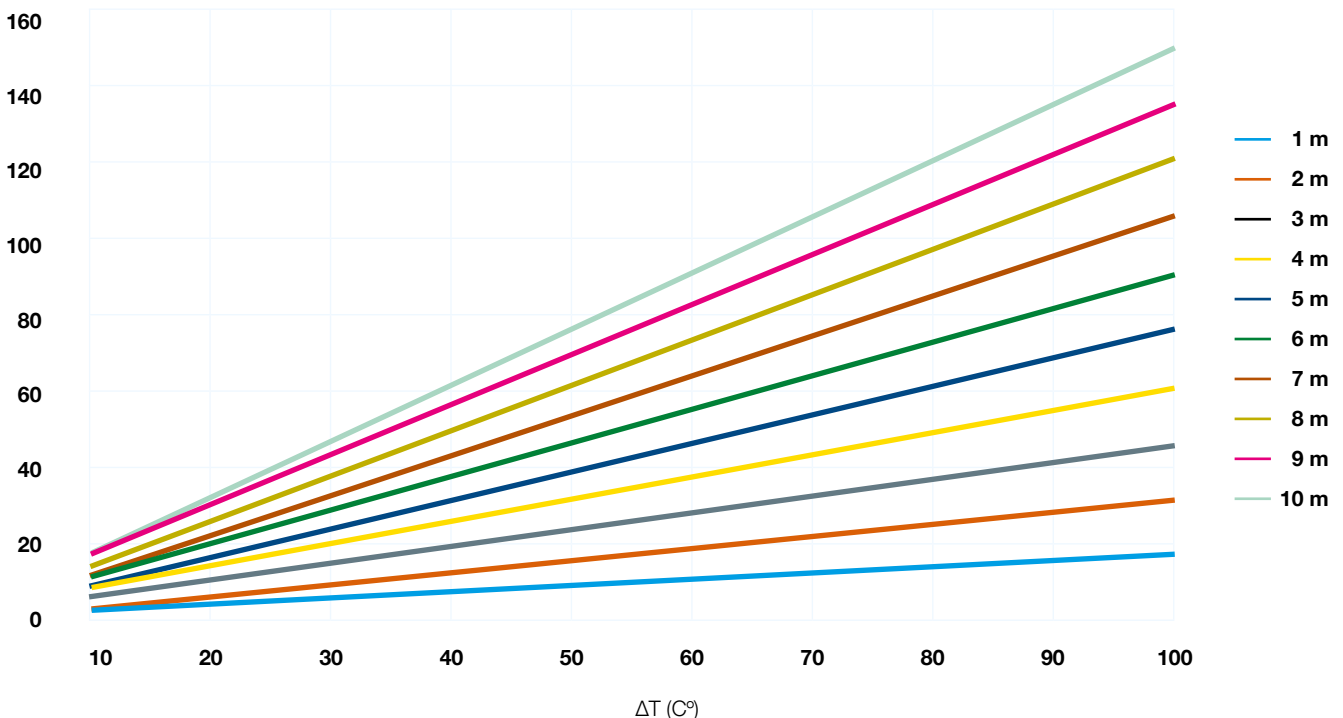

Example; at 70 °C for 8m Glassfiber Reinforced PP-R pipe, $\Delta L=?$

$$\Delta L = L * \Delta T * \beta$$

$$\Delta L = 8000 \text{ mm} * 70 * 0,000035$$

$$\Delta L = 19,6 \text{ mm}$$

PP-R Aluminium Foil Reinforced Pipe

This pipe consists of three layers: the pipe and the coat are made of PP-R with aluminium foil inbetween. The Aluminium foil is attached with wrapping welding and by using a special PP coating film to establish the mechanical connection between the aluminium foil and the PP-R layer.

Characteristics

- Low thermal expansion
- Oxygen impermeability
- Low heat loss
- High resistance to pressure and heat
- Easy forming, installation and application
- Hygenic
- Resistance to chemicals
- Low pressure loss due to the smoothness

Oxygen Impermeability

Oxygen penetration reduces the operating life by corroding the radiator and heater device. Oxygen diffusion from the atmospheric air is one of the most common ways of oxygen penetration into the system. Plastic pipes do not prevent this penetration. The aluminium layer increases the life of the radiator and the heater device by preventing.

Thermal Expansion in Aluminium Foil Reinforced PP-R Pipe

Calculation of Aluminium Foil Reinforced PP-R pipe thermal expansion is as follows:

$$\Delta L = L * \Delta T * \Phi$$

where

ΔT = The difference between environmental temperature and water temperature in Kelvin degrees (K) or Celsius (°C).

ΔL = Variation of length in mm.

L = Initial length of the pipe in m.

ΔT = The difference between environmental temperature and water temperature in Kelvin degrees (K) or Celsius (°C).

Φ = Coefficient of linear thermal expansion. The value of Φ is $0,30 * 10^{-4}$ (K-1) for Aluminium Foil Reinforced PP-R pipes.

Thermal Expansion of the Aluminium Foil Reinforced PP-R Pipe

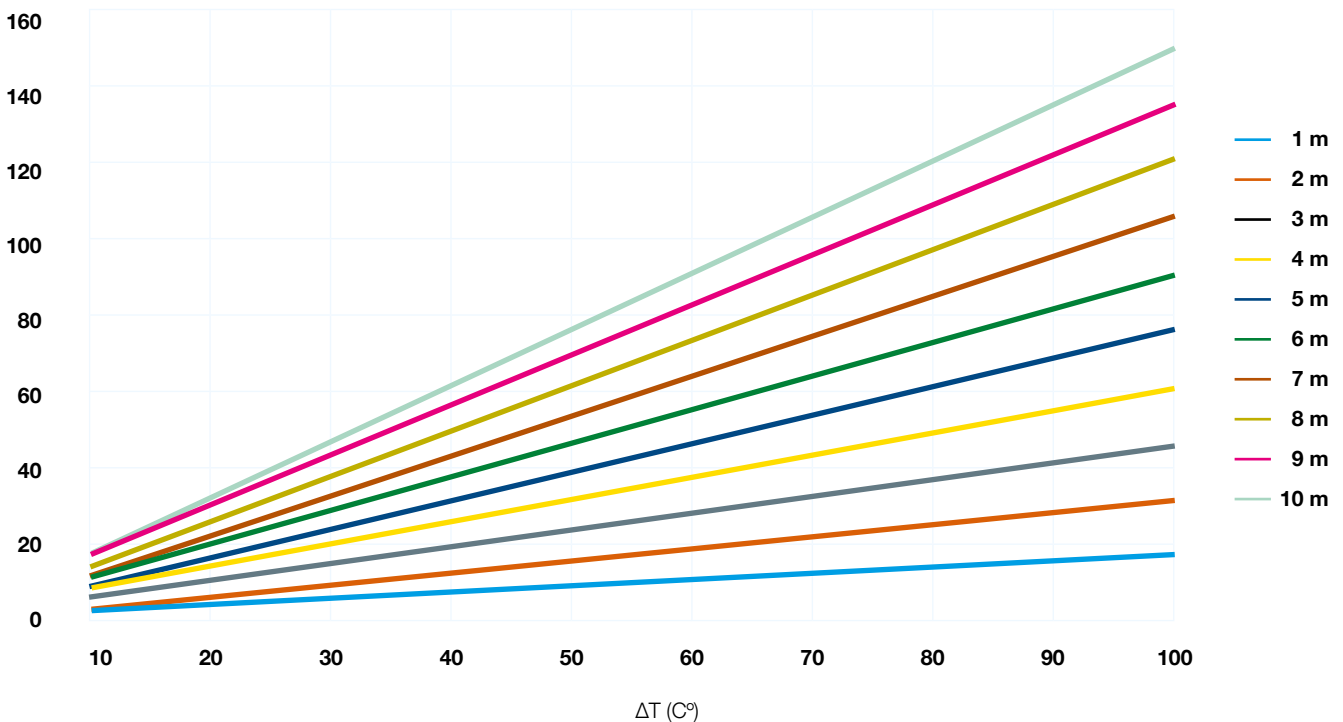

Example; at 70 °C for 8m Aluminium Foil Reinforced PP-R pipe, $\Delta L=?$

$$\Delta L = L * \Delta T * \Phi$$

$$\Delta L = 8000 \text{ mm} * 70 * 0,000030$$

$$\Delta L = 16,8 \text{ mm}$$

Expansion Comparison Among Standard Pipe, Glassfiber Pipe and Aluminium Foil Reinforced PP-R Pipe

As for seen from the examples above, at 70 °C for 8m of pipe expansion is;

ΔL (Standart PP-R Pipe) = 84 mm

ΔL (Glassfiber Reinforced PP-R Pipe) = 19,6 mm

ΔL (Aluminium Foil Reinforced PP-R Pipe) = 16,8 mm

In conclusion we can say Glassfiber and Aluminium Foil Reinforced PP-R pipes have very closer expansion values. Therefore Glassfiber Reinforced PP-R Pipe might be used easily instead of Aluminium Foil Reinforced PP-R pipe.

Expansion Comparison Among Standard Pipe, Glassfiber Pipe and Aluminium Foil Reinforced PP-R Pipe

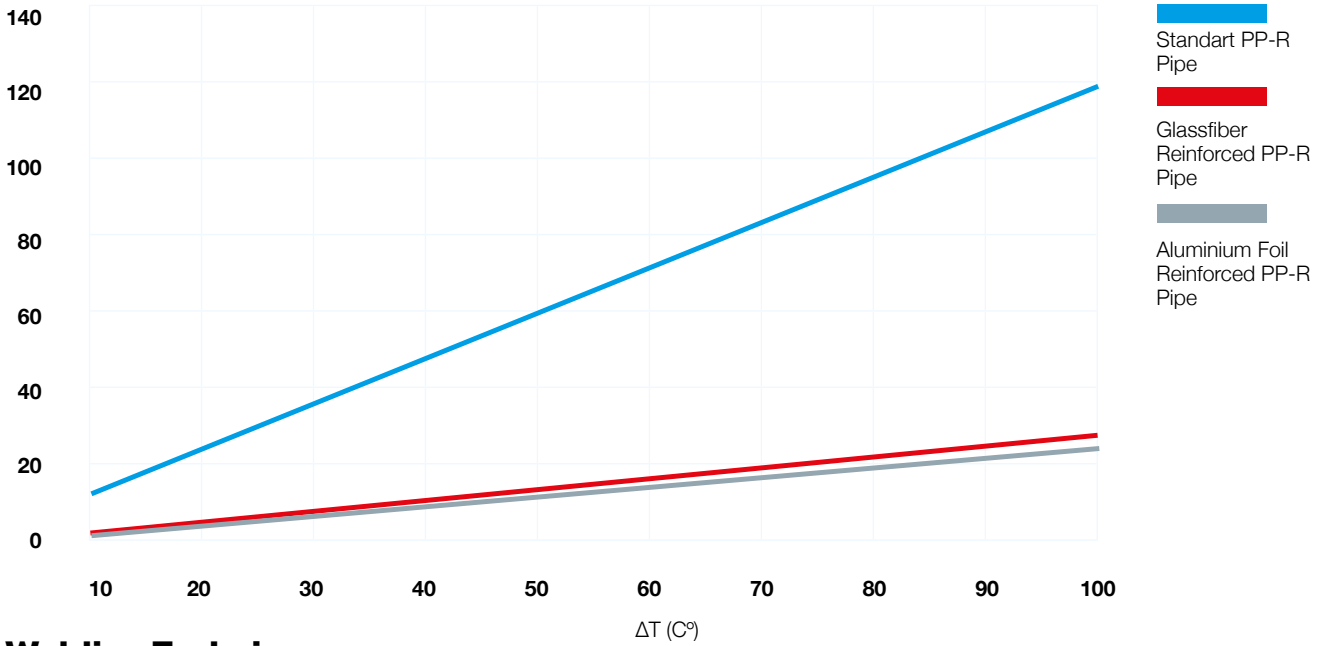

Welding Technique

The quality of an installation depends on the tightness, stability and lifetime of its connections. Fusion welding technique is safe because parts made of polypropylene create a homogenous connection within the process. When the welded joint cools down, it can be fully loaded. The resulting joints are very reliable, and they are as strong as the pipe itself. The pipe may even break before the socket welded joint under tension.

Welding takes only a few seconds. After cutting the pipe perpendicularly to its axis, both the pipes and the fittings (these must be clean if not please clean it with a cloth or alcohol-water solution) are heated with the welding machine (generally up to 260 °C +/- 10 °C) and they are joined without twisting. For proper connections please follow the table given below.



Outer Diameter (mm)	Heating Time (Secs)	Joining Time (Secs)	Cooling Time (Minutes)	Welding Depth (mm)
20	5	4	2	14,5
25	7	4	3	16
32	8	6	4	18
40	12	6	4	20,5
50	18	6	5	23,5
63	24	8	6	27,5
75	30	8	8	31
90	40	8	8	35,5
110	50	10	8	41,5
125	60	10	8	46,5

After Assembling Test Procedure

After assembling to start the test procedure system should be checked please see the steps below.

- Whole valves in the system must be turned off.
- While filling the system, first main valve is opened slightly.
- In order to avoid strong pressure impacts, pipe lines must be reduced air pressure from the utilization points at the highest and farthest sections.
- Separate tests are made by opening the valves of every zone.

When finishing the assembly of the installation, quality control of the system must be made by following below test procedure. Pressure testing shall be carried out in two stages.

1) For the first stage, a test pressure equal to the permissible working pressure plus 5 bar shall be produced twice within 30 minutes at 10 minute intervals. Then it shall be checked whether, over a further period of 30 minutes, the pressure has dropped by more than 0,6 bar and leakage has occurred.

2) The second stage shall follow the first stage without interval and shall last 2 hours. Then, it shall be checked whether the pressure has dropped by more than 0.2 bar and the pipework shows any signs of leakage.

Finally, If pressure drops more than the values given above in the manometer where test is observed, then leakage occurs. Leaking pipe line must be controlled and replaced or re-tightened.

Installation and Expansion Compensation

Pipes can be installed under or above the floor. The installation is very easy and quick. However, one has to pay attention to the following simple points when installing polypropylene pipes.

Pipes have to discharge the radial and axial extensions; compensation may be done by using Omega and U parts. As an alternative, metal compensator also can be used instead of the omega and U parts.

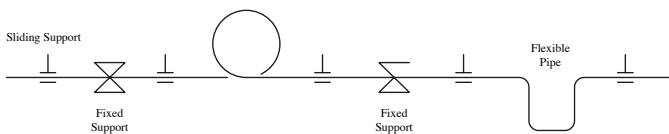

Figure 1- Omega and U part

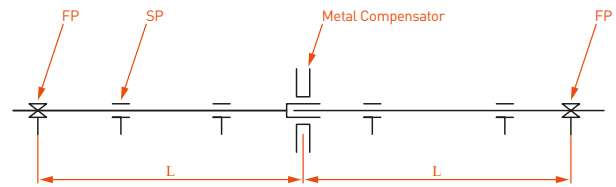

Figure 2- Metal Compensator

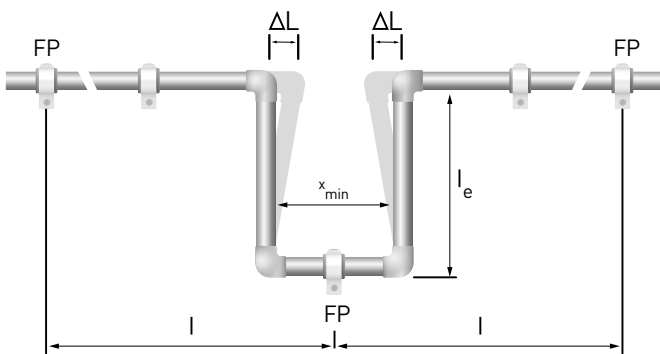

Figure 3-Distance of bending part

Length of the bending part is calculated by following equation.

$$Le = k * d * \Delta L$$

Le = Length of the bending part (U part, mm)

d = Outside diameter of the pipe (mm)

ΔL = Variation of length (mm)

k = Material dependent constant (15 for PP)

FP: Fixing point, support point, SP: Sliding point, support point.

CLAMPS INTERFACES

Clamps interface of standart PP-R pipes (cm)

Temperature Difference ΔT (°C)	Standart PP-R Pipe Diameter (mm)									
	20	25	32	40	50	63	75	90	110	125
0	85	105	125	140	165	190	205	220	250	270
20	60	75	90	100	120	140	150	160	180	195
30	60	75	90	100	120	140	150	160	180	195
40	60	70	80	90	110	130	140	150	170	185
50	60	70	80	90	110	130	140	150	170	185
60	55	65	75	85	100	115	125	140	160	175
70	50	60	75	80	95	105	115	125	140	150

Clamps interface of Glassfiber Reinforced PP-R pipes (cm)

Temperature Difference ΔT (°C)	Glassfiber Reinforced PP-R Pipe Diameter (mm)									
	20	25	32	40	50	63	75	90	110	125
0	115	130	150	165	185	215	240	260	280	295
20	90	100	115	130	145	165	185	200	215	225
30	90	100	115	130	145	165	185	200	210	220
40	80	90	105	120	135	155	175	190	200	210
50	80	90	105	120	135	155	175	190	180	190
60	70	80	100	115	130	145	165	180	175	180
70	65	75	90	105	120	135	155	175	175	180

Clamps interface of Aluminium Foil Reinforced PP-R pipes (cm)

Temperature Difference ΔT (°C)	Aluminium Foil Reinforced PP-R Pipe Diameter (mm)									
	20	25	32	40	50	63	75	90	110	125
0	155	170	195	220	245	270	285	300	325	345
20	120	130	150	170	190	210	220	230	250	265
30	120	130	150	170	190	210	220	230	240	250
40	110	120	140	160	180	200	210	220	210	220
50	110	120	140	160	180	200	210	220	210	220
60	100	110	130	150	170	190	200	210	200	210
70	90	100	120	140	160	180	190	200	200	200

CHEMICAL RESISTANCE

Polypropylene is a polymer with very high chemical resistance. Chemical resistance varies on factors such as composition, quality condition, time of affection, concentration and temperature. The tables shown below give chemical resistance in different temperature and concentrations.

The Symbols used in the table are:

S : Saturated solution

f : Resistant

p : Partially resistant

n : Nonresistant

Products	Concentration	Temperature		
	%	20 C°	60 C°	100 C°
Accumulator acid		f	f	
Acetic glacial acid	100	f	p	n
Acetic acid	50	f	f	
Acetic acid	10	f	f	
Acetic anhydride	100	f		
Acetone	100	f	p	n
Acrylonitrile	100	p		
Alum	All	f	f	
Ammonia	High	f	f	

Products	Concentration	Temperature		
	%	20 C°	60 C°	100 C°
Ammonia	10	f	f	
Ammonia	100	f	f	
Ammonium acetate	All	f	f	f
Ammonium carbonate	All	f	f	
Ammonium chloride	All	f	f	f
Ammonium nitrate	All	f	f	f
Ammonium metaphosphate	S	p	p	p
Ammonium phosphate	All	f	f	f
Ammonium sulphate	S	p	p	p
Ammonium bicarbonate	S	p	p	
Animal cooking oil		f	p	
Anti-freze car		f	f	
Aqua regia		f	n	
Barrium chloride	All	f	f	f
Beer		f		
Benzaldehyde		f	f	
Benzaldehyde	S	f	f	f
Benzene		p	n	
Benzoic acid	S	f	f	p
Benzoyl chloride	100	n		
Bitter almonds fragrance		f		
Bleach	12.50%	p	p	
Borax				
Boric acid	100	f	f	
Boric acid	S	f	f	
Brandy		f		
Bromine	100	n		
Bromine	High	n	n	
Bromine	Low	n	n	
Butane	100	f		
Butane (P)	100	f	f	
Butter		f	f	
Butyl alcohol	100	f	f	
Calcium nitrate	S	f	f	
Camphor		f		
Carvon tetrachloride	100	p	n	
Chlorine	100	n		
Chlorine (dry)	100	n	n	n
Chlorine (wet)	10	p	n	n
Chlorosulphonic	100	n	n	

Products	Concentration	Temperature		
	%	20 C°	60 C°	100 C°
Chromic acid	S	f	n	
Chromium (3) salts				
Chromium (6) salts				
Citric acid	S	f	f	f
Cocoa		f	f	p
Cod liver oil		f		
Cresol	100	f	p	
Cresol	S	f	p	
Cresol oil		f		
Cyclohexane	100	f		
Cyclohexanol	100	f	p	
Cyclohexanon	100	f	n	
Decahydronaphthlene	100	p	n	n
Dioxan	100	f	p	n
Distilled water	100	f	f	n
Engine oil		f	p	
Ethyl alcohol	100	f		
Ethyl alcohol	96	f	f	
Ethyl alcohol	50	f	f	
Ethers	100	f	p	
Ethyl alcohol (denatured)	10	f	f	
Ethyl chlorides	100	n		
Ethylene chlorides	100	p	p	
Ethylene tetrachloride	100	p	n	
Formaldehyde	40	f	f	
Formaldehyde	30	f	f	
Formaldehyde	10	f	f	
Formic acid	98	f	p	
Formic acid	90	f		
Formic acid	50	f	f	
Formic acid	10	f	f	f
Fruit-juice		f	f	
Fumic sulfuric acid		n	n	n
Galvanic solutions		f	f	
Glycerol	100	f	f	
Glycerol	High	f	f	
Glycerol	Low	f	f	f
Glycol	100	f	f	
Glycol	High	f	f	
Glycol	Low	f	f	f

Products	Concentration	Temperature		
	%	20 C°	60 C°	100 C°
Heptan	100	f	p	
Hexan	100	f	p	
Honey		f	f	
Hydrobromic acid	10	f	f	
Hydrofluoric acid	40	f	f	
Hydrogen peroxide water	30	f	p	
Hydrobromic acid	High	f	f	
Hydrogen peroxide water	10	f	f	
Hydrogen peroxide water	3	f	f	f
Ink		f	f	
Isooctane	100	f	p	
Lactic acid	90	f	f	
Lactic acid	50	f	f	
Lactic acid	10	f	f	f
Lacual water	100	f	f	f
Limestone		f	f	f
Linseed oil		f	f	
Mercury		f	f	
Mercury salts	100			
Methyl alcohol	50	f	f	
Methyl alcohol	100	f	f	
Methyl chloride	100	p		
Methym ethyl ketone	100	f	p	
Methylene diformammyde		f		
Milk		f	f	p
Mineral water		f	f	f
Naphtha		f	p	
Naphthalene	100	f		
Nitro benzene	100	p	p	
Normal gasoline		p	n	
Oil		n	n	
Oleic acid	100	f		
Olive oil		f	f	
Nitric acid	50	p	n	
Nitric acid	25	f	f	
Nitric acid	10	f	f	
Oxalic acid	S	f	f	f
Ozone	<0.5 ppm	p	p	
Paraffine	100	f	f	n
Petroleum	100	f	p	

Products	Concentration	Temperature		
	%	20 C°	60 C°	100 C°
Phenylamine		f	p	
Phenylmethylketone	100	p	p	
Phosphoric acid	S	f	p	
Phosphoric acid	50	f	f	
Phosphoric acid	10	f	f	f
Potassium carbonate	S	f	f	
Potassium chlorate	S	f	f	
Potassium chloride X	S	f	f	f
Potassium dichromate	S	f	f	f
Potassium hydroxide	50	f	f	
Potassium hydroxide	25	f	f	
Potassium hydroxide	10	f	f	
Potassium hypochlorite	5	f		
Potassium iodide	S	f	f	
Potassium nitrate	S	f	f	
Sea water		f	f	f
Shampoo		f	f	
Silicone oil		f	p	
Soap solution	S	f	f	
Soap solution	10	f	f	f
Sodium bicarbonate	S	f	f	f
Potassium sluphate	S	f	f	f
Propane @	100	f	f	f
Propane	100	f	f	f
Pyridine	100	f	p	
Sodium carbonate	S	f	f	
Sodium carbonate	10	f	f	f
Sodium chlorate	5	f		
Sodium chlorite	25	f	f	
Sodium chloride	S	f	f	f
Sodium disulphite	S	f	f	f
Sodium hidrokside	100	f	f	
Sodium hidrokside	50	f	f	
Sodium hidrokside	25	f	f	
Sodium hidrokside	10	f	f	
Sodium nitrate	S	f	f	
Sodium nitrite (P)	S	f		
Sodium perborate	S	f	f	f
Sodium phosphate	S	f	f	f

Products	Concentration	Temperature		
	%	20 C°	60 C°	100 C°
Sodium sulphate	S	f	f	f
Sodium sulphite	S	f	f	
Soluble coffee		f	f	f
Soy-bean oil		f	p	
Sulphochromic acid		n	n	
Sulphur	100	f	f	f
Sulphuric acid	96	f	p	
Sulphuric acid	50	f	f	
Sulphuric acid	25	f	f	
Sulphuric acid	10	f	f	f
Sulphurous anhydride	Low	f	f	
Spirits		f		
Stannus chloride	S	f	f	
Starch	All	f	f	
Stearic acid	100	f		
Succinic acid	100	f	f	
Super gasoline		p	n	
Syntetic deterive		f	f	f
Tar		f	p	
Tartaric acid	S	f	f	
Tartaric acid	10	p	p	
Tetrahydrofurane	100	p	n	
Tetrahydronaphtalene	100	p	n	
Thea		f	f	p
Thiophene	100	p	n	
Tlouen	100	p	n	
Tomatoes-juice		f	f	
Tooth paste		f	f	
Trichlorcethylene	100	p	p	
Turpentine		n	n	n
Turpentine oil		p	n	
Two stroke engine oil		p	p	
Typewriter oil		f	p	
Urea	S	f	f	
Vaselina		f	p	
Vegetable cooking oil		f	p	
Water	100	f	f	f
Whipped cream		f		
Whisky	40	f		
Xylene or xylol	100	p	n	

Metal Insert Used For The Fittings Are BRASS MS 58
Which Means

Copper

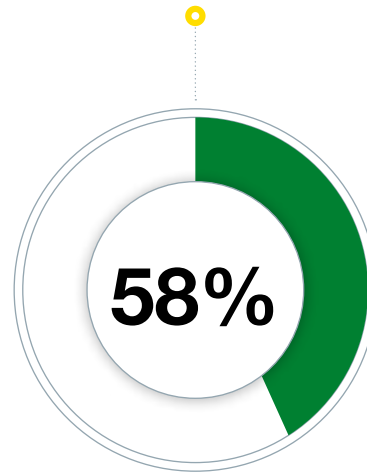

Zinc

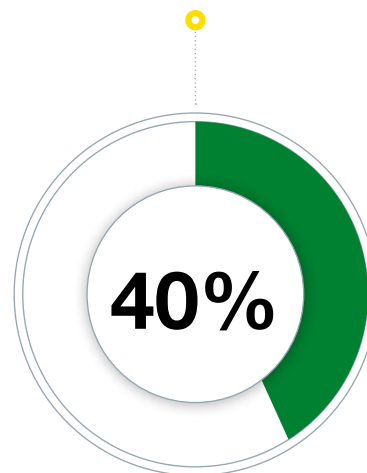

Others

Pb, Sn, P, Mn, Fe, Ni, Si, Mg, Cr, Al, etc.

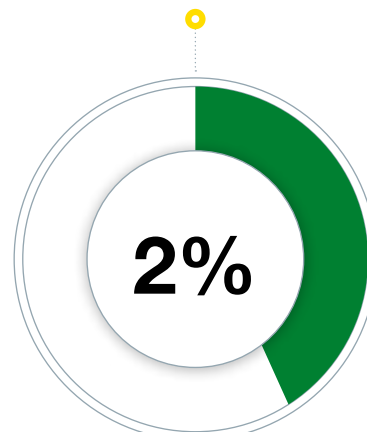

PP-RCT PIPES

- Polypropylene Random Copolymer with improved temperature resistance and enhanced crystalline structure.
- Leads to more and smaller crystals compared to PP-R.
- Higher strength at higher temperatures.
- 25% less expansion in multilayer PP-RCT pipes compared to multilayer PP-R pipes.
- Safety and life-time longer which means lower costs.
- Higher pressure rates with lower thickness.
- 17% higher flow rate.
- 5 MPa at 70°C in comparison to 3,21 MPa for standard PP-R.
- More than 50% improved long-term strength enables designers to achieve higher pipe hydraulic capacity and higher pressure.
- Lightweight according to higher ID compared to PP-R.
- Provides resistance to highly acidic and basic solutions.
- Better mechanical characteristics than PP-R.

DIMENSIONS AND TOLERANCES

S 2,5

Outside Ø mm.	Tolerance mm.	Thickness mm.	Tolerance mm.	Inside Ø mm.	In" inches
20	+0,3/-0	3.4	+0,5/-0	13,20	1/2"
25	+0,3/-0	4,2	+0,6/-0	16,60	3/4"
32	+0,3/-0	5,4	+0,7/-0	21,20	1"
40	+0,4/-0	6,7	+0,8/-0	26,60	1 1/4"
50	+0,5/-0	8,3	+1,0/-0	33,40	1 1/2"
63	+0,6/-0	10,5	+1,2/-0	42,00	2"
75	+0,7/-0	12,5	+1,4/-0	50,00	2 1/2"
90	+0,9/-0	15,0	+1,7/-0	60,00	3"
110	+1,0/-0	18,3	+2,0/-0	73,40	4"
125	+1,2/-0	20,8	+2,2/-0	83,40	5"
160	+1,5/-0	26,6	+2,8/-0	106,80	6"

S 3,2

Outside Ø mm.	Tolerance mm.	Thickness mm.	Tolerance mm.	Inside Ø mm.	In" inches
20	+0,3/-0	2,8	+0,4/-0	14,00	1/2"
25	+0,3/-0	3,5	+0,5/-0	18,00	3/4"
32	+0,3/-0	4,4	+0,6/-0	23,20	1"
40	+0,4/-0	5,5	+0,7/-0	29,00	1 1/4"
50	+0,5/-0	6,9	+0,8/-0	36,20	1 1/2"
63	+0,6/-0	8,6	+1,0/-0	45,80	2"
75	+0,7/-0	10,3	+1,2/-0	54,40	2 1/2"
90	+0,9/-0	12,3	+1,4/-0	65,40	3"
110	+1,0/-0	15,1	+1,7/-0	79,80	4"
125	+1,2/-0	17,1	+1,9/-0	90,80	5"
160	+1,5/-0	21,9	+2,3/-0	116,20	6"

S 4

Outside Ø mm.	Tolerance mm.	Thickness mm.	Tolerance mm.	Inside Ø mm.	In" inches
20	+0,3/-0	2,3	+0,4/-0	15,40	1/2"
25	+0,3/-0	2,8	+0,4/-0	19,40	3/4"
32	+0,3/-0	3,6	+0,5/-0	24,80	1"
40	+0,4/-0	4,5	+0,6/-0	31,00	1 1/4"
50	+0,5/-0	5,6	+0,7/-0	38,80	1 1/2"
63	+0,6/-0	7,1	+0,7/-0	48,80	2"
75	+0,7/-0	8,4	+0,9/-0	58,20	2 1/2"
90	+0,9/-0	10,1	+1,2/-0	69,80	3"
110	+1,0/-0	12,3	+1,4/-0	85,40	4"
125	+1,2/-0	14,0	+1,5/-0	97,00	5"
160	+1,5/-0	17,9	+1,9/-0	124,20	6"

S 5

Outside Ø mm.	Tolerance mm.	Thickness mm.	Tolerance mm.	Inside Ø mm.	In" inches
20	+0,3/-0	1,9	+0,3/-0	16,20	1/2"
25	+0,3/-0	2,3	+0,4/-0	20,40	3/4"
32	+0,3/-0	2,9	+0,4/-0	26,20	1"
40	+0,4/-0	3,7	+0,5/-0	32,60	1 1/4"
50	+0,5/-0	4,6	+0,6/-0	40,80	1 1/2"
63	+0,6/-0	5,8	+0,7/-0	51,40	2"
75	+0,7/-0	6,8	+0,8/-0	61,40	2 1/2"
90	+0,9/-0	8,2	+1,0/-0	73,60	3"
110	+1,0/-0	10,0	+1,1/-0	90,00	4"
125	+1,2/-0	11,4	+1,3/-0	102,20	5"
160	+1,5/-0	14,6	+1,6/-0	130,80	6"

LIFE-TIME ACCORDING TO TEMPERATURES AND PRESSURE RATES

Temperature °C	Years of Services	Pipe Series (S)			
		5	4	3,2	2,5
		Standart Dimension Ratio (SDR)			
		11	9	7,4	6
Allowable Operating Pressure (Bar)					
10	1	19,0	24,0	30,2	38,0
	5	18,4	23,2	29,3	36,9
	10	18,2	22,9	28,9	34,4
	25	17,9	22,5	28,4	35,7
	50	17,7	22,2	28,0	35,3
	100	17,4	21,9	27,6	34,8
20	1	16,6	20,9	26,3	33,1
	5	16,0	20,2	25,4	32,0
	10	15,8	19,9	25,1	31,6
	25	15,5	19,6	24,6	31,0
	50	15,3	19,3	24,3	30,6
	100	15,1	19,0	24,0	30,2
30	1	14,3	18,1	22,7	28,7
	5	13,9	17,4	22,0	27,7
	10	13,6	17,2	21,7	27,3
	25	13,4	16,9	21,2	26,8
	50	13,2	16,6	20,9	26,4
	100	13,0	16,4	20,6	26,0
40	1	12,3	15,5	19,6	24,6
	5	11,9	15,0	18,9	23,8
	10	11,7	14,7	18,6	23,4
	25	11,5	14,4	18,2	22,9
	50	11,3	14,2	17,9	22,6
	100	11,1	14,0	17,6	22,2
50	1	10,5	13,3	16,7	21,0
	5	10,1	12,0	16,1	20,3
	10	10,0	12,6	15,8	19,9
	25	9,7	12,3	15,5	19,5
	50	9,6	12,1	15,2	19,2
	100	9,4	11,9	15,0	18,9
60	1	8,9	11,2	14,2	17,8
	5	8,6	10,8	13,6	17,1
	10	8,4	10,6	13,4	16,8
	25	8,2	10,4	13,1	16,5
	50	8,1	10,2	12,8	16,2
70	1	7,5	9,4	11,9	15,0
	5	7,2	9,1	11,4	14,4
	10	7,0	8,9	11,2	14,1
	25	6,9	8,7	10,9	13,8
	50	6,8	8,5	10,7	13,5
80	1	6,2	7,9	9,9	12,5
	5	6,0	7,5	9,5	12,0
	10	5,9	7,4	9,3	11,7
	25	5,7	7,2	9,1	11,4
95	1	4,7	5,9	7,4	9,4
	5	4,4	5,6	7,1	8,9

LIFE-TIME ACCORDING TO TEMPERATURES AND PRESSURE RATES

Characteristic	Requirement	Test parameters		Test method
		Parameter	Value	
Longitudinal reversion	≤ %2	Test temperature PP-RCT Duration of exposure for: en ≤ 8 mm 8mm ≤ en ≤ 16mm en > 16mm Number of test pieces	135 °C 1 h 2 h 4 h 3	Method B of ISO 2505 (oven test)
Thermal stability by hydrostatic pressure testing	No bursting during the test period	Test temperature Hydrostatic stress Test period Number of test pieces	110 °C 2,6 MPa 8760 h 1	ISO 1167-1 ISO 1167-2
Impact resistance	≤ %10	Test temperature Number of test pieces	0 °C 10	ISO 9854-1 ISO 9854-2
MFI (Raw material)	≤ 0,5g /10 min	Test temperature Mass Number of test pieces	230 °C 2,16 kg 3	ISO 1133-1
MFI (Pipe)	%30 maximum difference compared with compound from the same batch	Test temperature Mass Number of test pieces	230 °C 2,16 kg 3	

Norms in Use

TS-DIN 1988

Drinking water line installation.

TS-DIN 2999

Whitworth pipe threads for tubes and Fittings.

TS-DIN 4109

Sound insulation in building construction.

TS-DIN 8077

Polypropylene (PP-R) pipes dimensions.

TS-DIN 8078

Polypropylene (PP-R) pipes general quality requirements and testing.

TS-DIN 16928

Pipe connections and components - Pipes of thermoplastic materials; pipe joints, elements for pipes, laying; general directions.

TS-DIN 16962 (6-9)

Pipe joints and elements for polypropylene (PP-R) pressure pipelines, types 1 and 2; injection moulded elbows for socket-

welding, dimension.

TS-DIN 16962.5

Pipe joints and components of polypropylene (PP-R) For pipes under pressure, Part 5: General quality requirements, testing.

TS-DVS 2207.11

Welding regulations for plastic pipes.

TS-DVS 2208.1

Machines and devices for welding thermoplastic pipes.

TS-EN ISO 15874 -2-3

Plastics piping systems for hot and cold water installations polypropylene (PP-R)

TSE K 28

Multi-layer glass Fiber pipes From Polypropylene (PP) - pressure pipes used for hot and cold water systems.

TS 9937

Plastic Pipes from Polypropylene (PP) - general purpose.

Transport & Storage

Транспортировка и хранение

النقل و التخزين

• Store the pipe and fittings sheltered from sun and rain. Do not expose the UV radiation for a long time.

• Хранить трубы и фитинги в защищенном от солнца и дождя месте. Не подвергайте УВ излучению в течении длительного времени.

• تخزين الأنابيب وملحقاتها بعيداً عن اشعة الشمس والمطر لا تعرضها للأشعة فوق البنفسجية لفترة طويلة



• Do not store at temperatures below 0°C. Impacts can form cracks on pipes.

• Не храните при температуре ниже 0°C. Есть вероятность образования трещин на трубах.

• لا تخزين في درجة حرارة اقل من 0 درجة مئوية التآثيرات: قد تسبب تشقق في الأنابيب



• Protect the impact of hard and sharp objects.

• Защищайте от воздействия твердых и острых предметов.

• الأجسام الحادة والصلهه قد تسبب التلف



• Although it is quite durable please do not throw of during loading and unloading.

• Не бросайте во время погрузки и разгрузки.

• الرجاء عدم رمي خلال التحميل والتفريغ



• Please move carefully and stacked.

• Передвигайте и складывайте осторожно.

• الرجاء نقل بعناية وترتيب



PE-RT PIPE

PE-RT pipe (Polyethylene - Raised Temperature Resistance) is a shortened version of heat resistant PE pipe. PE-RT pipes are produced by our experienced and expert team in high quality machines in accordance with ISO 22391-2 standard.

PE-RT Pipe Characteristic

- PE-RT pipes are produced from environmentally friendly recyclable thermoplastic materials, Type 2 PE-RT raw material.
- PE-RT pipes can be laid easily in cold weather without the need for heating thanks to its flexibility feature.
- PE-RT pipes are resistant to high heat and pressure due to specially developed raw materials and have high resistance against chemicals.
- PE-RT pipes can be used in drinking water.
- After the pipes are produced, they are packed in coils and easily transported.
- The outer diameter of the pipes is 16mm, and the wall thickness is 2mm.
- Red, Blue, two color sheaths, standard and oxygen barrier types are available.

PE-RT Pipe Usage Areas

- Hot & cold clean water installations
- Central heating
- Underfloor heating
- Radiator connections and
- It is used in industrial applications.

What is the difference between PE-RT pipe from other pipes?

Other types of pipes on the market lose their flexibility, especially in cold weather conditions. Heating devices are needed for the system to be laid. PE-RT pipes have a flexible structure due to their raw material structure and thus can be installed without the need for heating in cold weather.

PE-RT Type 2 raw material PE-RT pipes have long-term hydrostatic strength at high temperature without the need for cross-linking existing in PE-X pipes. Thanks to this feature, it is environmentally friendly and recyclable.

It is suitable for use in drinking water as it does not contain any chemicals that allow cross-linking, as in PE-X pipes. It is not harmful to human health.

Two types of plastic pipes are used in floor heating and radiator systems. One of them is PE-X (polyethylene cross-linked, PE cross-linked) and the other is PE-RT (polyethylene raised temperature resistance). Both PE-X and PE-RT pipes are made of polyethylene raw material. There are sub-types of PE-X pipes namely; PE-Xa, PE-Xb, PE-Xc. In PE-X pipes, the resistance of the pipe to heat and pressure increases from c to a. On the other hand, the flexibility properties of the pipes decrease. Pipes must be laid by heating in order to gain flexibility during application. This situation causes losses in time and labor. PE-RT pipes, on the other hand, have the highest flexibility feature thanks to the specially developed PE-RT Type 2 raw material in its structure, while maintaining the high temperature and pressure resistance properties of the pipe. Thus, PE-RT pipes can be laid cold without the need for heating. PE-RT pipes have a life span of at least 50 years when installed with the right material selection and correct assembly techniques.

PE-RT Pipe Pressure Resistance

16x2 mm PE-RT Pipe (SF=1,5)		
Temperature °C	Year	Pressure (Bar)
20	1	18,6
	5	18,2
	10	18,1
	25	17,9
	50	17,8
30	1	16,9
	5	16,6
	10	16,5
	25	16,3
	50	16,1
40	1	15,3
	5	15,0
	10	14,8
	25	14,6
	50	14,5
50	1	13,6
	5	13,3
	10	13,2
	25	13,0
	50	12,9
60	1	12,0
	5	11,7
	10	11,5
	25	11,4
	50	11,2
70	1	10,3
	5	11,1
	10	9,9
	25	9,8
	50	9,6
80	1	8,8
	5	8,5
	10	8,4
	25	8,2
95	1	6,5
	5	6,3
	10	6,2



We owe
LIVEABLE CITIES
to our children





formül[®]

PP-R PIPES

2

PIPE PN 10

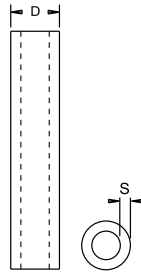
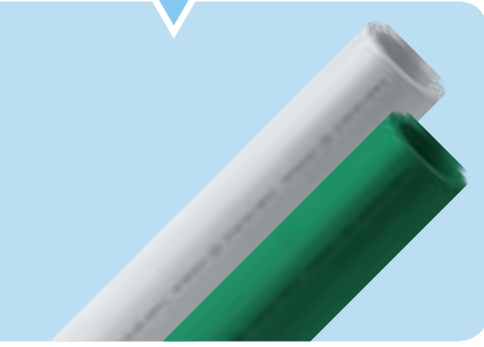

PN 10 Труба | PN 10 انبوب

Code	Size (ø)	S	D	Packing Unit/mt
DUZ-200010	20	1.9	20.3	140
DUZ-250010	25	2.3	25.3	100
DUZ-320010	32	2.9	32.3	60
DUZ-400010	40	3.7	40.4	40
DUZ-500010	50	4.6	50.5	24
DUZ-630010	63	5.8	63.6	20
DUZ-750010	75	6.8	75.7	12
DUZ-900010	90	8.2	90.9	8
DUZ-110010	110	10	111	4
DUZ-125010	125	11.4	126.2	4

PIPE PN 16

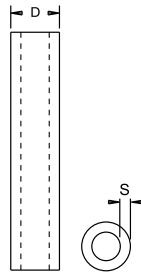
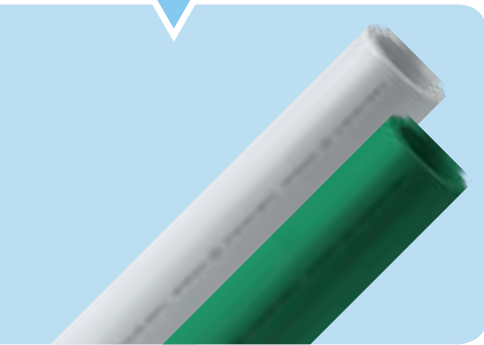

PN 16 Труба | PN 16 انبوب

Code	Size (ø)	S	D	Packing Unit/mt
DUZ-200016	20	2.8	20.3	140
DUZ-250016	25	3.5	25.3	100
DUZ-320016	32	4.4	32.3	60
DUZ-400016	40	5.5	40.4	40
DUZ-500016	50	6.9	50.5	24
DUZ-630016	63	8.6	63.6	20
DUZ-750016	75	10.3	75.7	12
DUZ-900016	90	12.3	90.9	8
DUZ-110016	110	15.1	111	4
DUZ-125016	125	17.1	126.2	4

PIPE PN 20

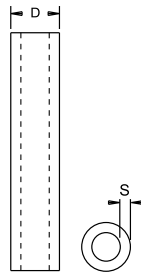
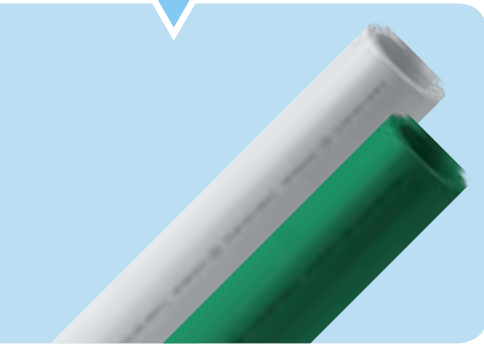

PN 20 Труба | PN 20 انبوب

Code	Size (ø)	S	D	Packing Unit/mt
DUZ-200020	20	3.4	20.3	140
DUZ-250020	25	4.2	25.3	100
DUZ-320020	32	5.4	32.3	60
DUZ-400020	40	6.7	40.4	40
DUZ-500020	50	8.3	50.5	24
DUZ-630020	63	10.5	63.6	20
DUZ-750020	75	12.5	75.7	12
DUZ-900020	90	15.0	90.9	8
DUZ-110020	110	18.3	111	4
DUZ-125020	125	20.8	126.2	4

FOROXI PIPE PN 20

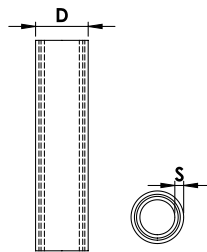
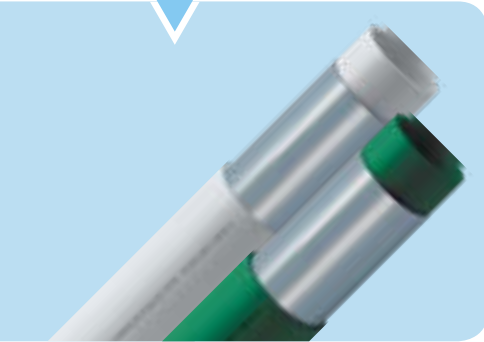

Труба FOROXI (с внутренней армировкой) PN20 | انبوب مغلف بالالمنيوم PN20

Code	Size (ø)	S	D	Packing Unit/mt
OFL-200020	20	2.8	20.3	140
OFL-250020	25	3.5	25.3	100
OFL-320020	32	4.4	32.3	60
OFL-400020	40	5.5	40.4	40
OFL-500020	50	6.9	50.5	24
OFL-630020	63	8.6	63.6	20
OFL-750020	75	10.3	75.7	12
OFL-900020	90	12.3	90.9	8
OFL-110020	110	15.1	111	4

Труба FOROXI (с внутренней армировкой) PN25 | انبوب مغلف بالالمنيوم PN25

Code	Size (ϕ)	S	D	Packing Unit/mt
OFL-200025	20	3.4	20.3	140
OFL-250025	25	4.2	25.3	100
OFL-320025	32	5.4	32.3	60
OFL-400025	40	6.7	40.4	40
OFL-500025	50	8.3	50.5	24
OFL-630025	63	10.5	63.6	20
OFL-750025	75	12.5	75.7	12
OFL-900025	90	15.0	90.9	8
OFL-110025	110	18.3	111	4

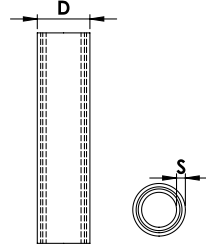

FOROXI PIPE PN 25



Труба армированная со стекловолокном PN20 | انبوب كوميوزيت PN20

Code	Size (ϕ)	S	D	Packing Unit/mt
DGF-200020	20	2.8	20.3	140
DGF-250020	25	3.5	25.3	100
DGF-320020	32	4.4	32.3	60
DGF-400020	40	5.5	40.4	40
DGF-500020	50	6.9	50.5	24
DGF-630020	63	8.6	63.6	20
DGF-750020	75	10.3	75.7	12
DGF-900020	90	12.3	90.9	8
DGF-110020	110	15.1	111	4
DGF-125020	125	17.1	126.2	4

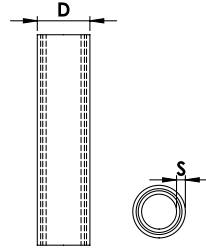

COMPOSITE PIPE PN 20

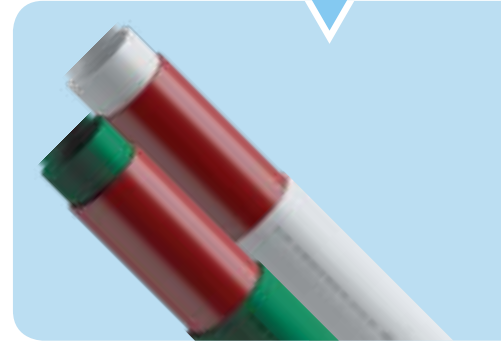

Труба армированная со стекловолокном PN25 | انبوب كوميوزيت PN25

Code	Size (ϕ)	S	D	Packing Unit/mt
DGF-200025	20	3.4	20.3	140
DGF-250025	25	4.2	25.3	100
DGF-320025	32	5.4	32.3	60
DGF-400025	40	6.7	40.4	40
DGF-500025	50	8.3	50.5	24
DGF-630025	63	10.5	63.6	20
DGF-750025	75	12.5	75.7	12
DGF-900025	90	15.0	90.9	8
DGF-110025	110	18.3	111	4
DGF-125025	125	20.8	126.2	4

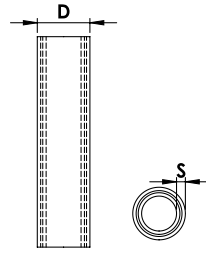

COMPOSITE PIPE PN 25

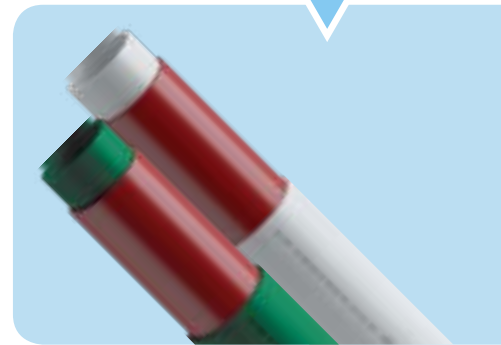

snowdrop series

call for
**Very Fast
Delivery**



Available Colours

formül[®]

3

PP-R FITTINGS

Компенсатор Омега PN20 | PN20 جسر لجام

Code	Size (ø)	S	D	L	Packing Unit/pcs
OMG-200020	20	3.4	20.3	350	85
OMG-250020	25	4.2	25.3	350	45
OMG-320020	32	5.4	32.3	350	22
OMG-400020	40	6.7	40.4	350	15

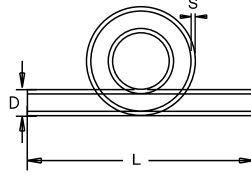

OMEGA

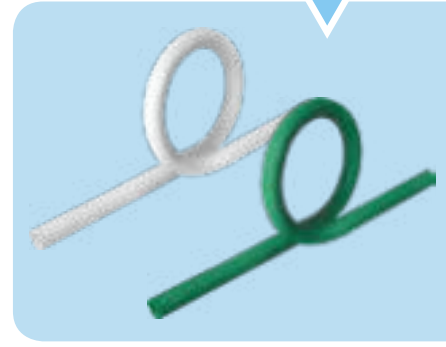

Обводное колено PN20 | PN20 انبوب منحرف

Code	Size (ø)	S	D	L	Packing Unit/pcs
KVS-200020	20	3.4	20.3	350	160
KVS-250020	25	4.2	25.3	350	100
KVS-320020	32	5.4	32.3	350	65
KVS-400020	40	6.7	40.4	350	40

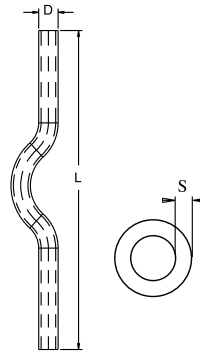

CROSSOVER



Обводное колено раструбное PN25 | PN25 انبوب منحرف مع وصل

Code	Size (ø)	ø d ₁	E	L	Packing Unit/pcs
MKV-200000	20	19.5	14.5	162	125
MKV-250000	25	24.5	16	200	80
MKV-320000	32	31.5	18	240	30

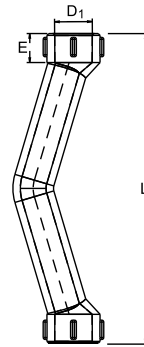

CROSSOVER WITH SOCKET - LONG



call for
**Very Fast
Delivery**



dolphin
series



Available Colours

CROSSOVER WITH SOCKET - SHORT

Обводное колено (короткое) PN25 | انبوب منحرف مع وصل PN25

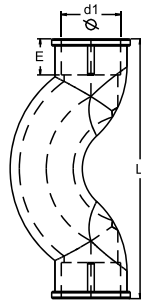

Code	Size (σ)	σ d ₁	E	L	Packing Unit/pcs
MKK-200000	20	19.5	14.5	86	200
MKK-250000	25	24.5	16	95	125
MKK-320000	32	31.5	18	117	60

BEND

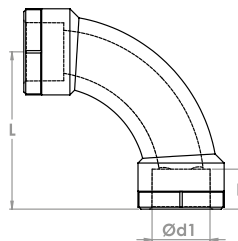

Code	Size (σ)	σ d ₁	E	L	Packing Unit/pcs
KVD-250000	25	24.5	16	66	125
KVD-320000	32	31.5	18	83	60

SOCKET

Муфта PN25 | وصل لجام PN25

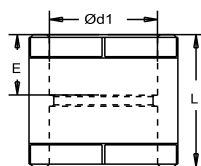

Code	Size (σ)	σ d ₁	L	E	Packing Unit/pcs
MAN-200000	20	19.5	34	14.5	600
MAN-250000	25	24.5	37	16	300
MAN-320000	32	31.5	41	18	200
MAN-400000	40	39.4	45	20.5	100
MAN-500000	50	49.4	52	23.5	60
MAN-630000	63	62.5	60	27.5	36
MAN-750000	75	74.2	65	31	24
MAN-900000	90	89.2	71	35.5	16
MAN-110000	110	109	79	41.5	6
MAN-125000	125	123.9	104	46.5	4



Муфта переходная ВН/ВН PN25 | PN25 نفاصه

Code	Size (ø)	Ø d1	Ø d2	E1	E2	L	Packing Unit/pcs
RDM-252000	25/20	24.5	19.5	16	14.5	35	400
RDM-322000	32/20	31.5	19.5	18	14.5	38	300
RDM-322500	32/25	31.5	24.5	18	16	40	250
RDM-402000	40/20	39.4	19.5	20.5	14.5	47	150
RDM-402500	40/25	39.4	24.5	20.5	16	47	150
RDM-403200	40/32	39.4	31.5	20.5	18	47	125
RDM-502000	50/20	49.4	19.5	23.5	14.5	50	100
RDM-502500	50/25	49.4	24.5	23.5	16	50	100
RDM-503200	50/32	49.4	31.5	23.5	18	50	80
RDM-504000	50/40	49.4	39.4	23.5	20.5	50	75
RDM-632000	63/20	62.5	19.5	27.5	14.5	60	40
RDM-632500	63/25	62.5	24.5	27.5	16	60	40
RDM-633200	63/32	62.5	31.5	27.5	18	60	40
RDM-634000	63/40	62.5	39.4	27.5	20.5	65	40
RDM-635000	63/50	62.5	49.4	27.5	23.5	66	35

REDUCER SOCKET

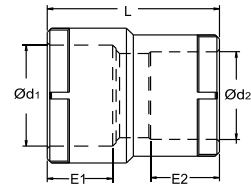

Муфта переходная ВН/НР PN25 | PN25 نفاصه

Code	Size (ø)	Ø d1	L	E	D	Packing Unit/pcs
RDS-252000	25/20	19.5	39	14.5	25	600
RDS-322000	32/20	19.5	39	14.5	32	400
RDS-322500	32/25	24.5	43	16	32	300
RDS-402000	40/20	19.5	39	14.5	40	200
RDS-402500	40/25	24.5	43	16	40	200
RDS-403200	40/32	31.5	48	18	40	150
RDS-502500	50/25	24.5	43	16	50	100
RDS-503200	50/32	31.5	48	18	50	100
RDS-504000	50/40	39.4	52	20.5	50	80
RDS-633200	63/32	31.5	48	18	63	60
RDS-634000	63/40	39.4	52	20.5	63	60
RDS-635000	63/50	49.4	60	23.5	63	50
RDS-754000	75/40	39.4	52	20.5	75	40
RDS-755000	75/50	49.4	60	23.5	75	40
RDS-756300	75/63	62.5	67	27.5	75	30
RDS-905000	90/50	49.4	60	23.5	90	20
RDS-906300	90/63	62.5	67	27.5	90	20
RDS-907500	90/75	74.2	72	31	90	16
RDS-116300	110/63	62.5	67	27.5	110	16
RDS-117500	110/75	74.2	72	31	110	16
RDS-119000	110/90	89.2	90	35.5	110	16
RDS-129000	125/90	89.2	120	35.5	125	6
RDS-121100	125/110	109	120	41.5	125	5

REDUCER

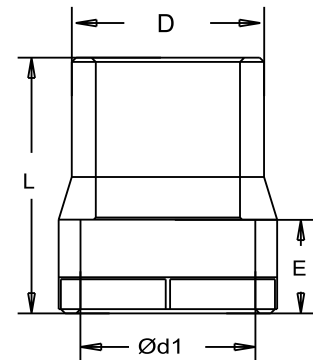

90° REDUCER ELBOW

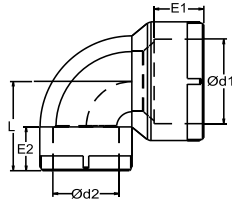

90° Угольник переходной PN25 | PN25 90° كوع منقّص

Code	Size (ø)	Ø d1	Ø d2	E1	E2	L	Packing Unit/pcs
RDD-252000	25/20	24.5	19.5	16	14.5	29	250
RDD-322500	32/25	31.5	24.5	18	16	33	150

90° TAIL ELBOW

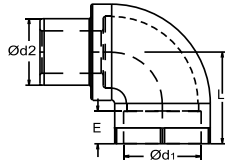

90° Угольник переходной внутр./наруж. PN25 | PN25 90° كوع زاويه 90° منقّص

Code	Size (ø)	Ø d1	Ø d2	L	E	Packing Unit/pcs
KDR-200090	20	19.5	20.3	23	14.5	300
KDR-250090	25	24.5	25.3	25	16	200
KDR-320090	32	31.5	32.3	28	18	100

90° ELBOW

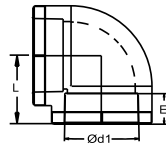

90° Угольник PN25 | PN25 90° كوع زاويه 90°

Code	Size (ø)	Ø d1	L	E	Packing Unit/pcs
DIR-200090	20	19.5	23	14.5	400
DIR-250090	25	24.5	25	16	250
DIR-320090	32	31.5	28	18	125
DIR-400090	40	39.4	32	20.5	60
DIR-500090	50	49.4	37	23.5	35
DIR-630090	63	62.5	54	27.5	15
DIR-750090	75	74.2	60	31	12
DIR-900090	90	89.2	76	35.5	6
DIR-110090	110	109	94	41.5	2
DIR-125090	125	123.9	110	46.5	2

REDUCER TEE

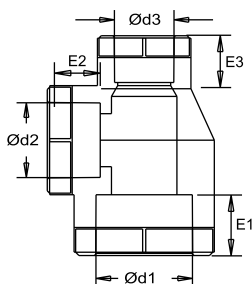

Тройник переходной PN25 | PN25 تى منقّص

Code	Size (ø)	Ø d1	E1	Ø d2	E2	Ø d3	E3	Packing Unit/pcs
ITE-202520	20/25/20	19.5	14.5	24.5	16	19.5	14.5	200
ITE-252020	25/20/20	24.5	16	19.5	14.5	19.5	14.5	150
ITE-252025	25/20/25	24.5	16	19.5	14.5	24.5	16	200
ITE-252520	25/25/20	24.5	16	24.5	16	19.5	14.5	150
ITE-322020	32/20/20	31.5	18	19.5	14.5	19.5	14.5	100
ITE-322025	32/20/25	31.5	18	19.5	14.5	24.5	16	100
ITE-322032	32/20/32	31.5	18	19.5	14.5	31.5	18	100
ITE-322520	32/25/20	31.5	18	24.5	16	19.5	14.5	100
ITE-322525	32/25/25	31.5	18	24.5	16	24.5	16.0	100
ITE-322532	32/25/32	31.5	18	24.5	16	31.5	18	100
ITE-402040	40/20/40	39.4	20.5	19.5	14.5	39.4	20.5	50
ITE-402540	40/25/40	39.4	20.5	24.5	16	39.4	20.5	50
ITE-403240	40/32/40	39.4	20.5	31.5	18	39.4	20.5	40
ITE-502050	50/20/50	49.4	23.5	19.5	14.5	49.4	23.5	30
ITE-502550	50/25/50	49.4	23.5	24.5	16	49.4	23.5	30
ITE-503250	50/32/50	49.4	23.5	31.5	18	49.4	23.5	30
ITE-504050	50/40/50	49.4	23.5	39.4	20.5	49.4	23.5	25
ITE-632063	63/20/63	62.5	27.5	19.5	14.5	62.5	27.5	24
ITE-632563	63/25/63	62.5	27.5	24.5	16	62.5	27.5	24
ITE-633263	63/32/63	62.5	27.5	31.5	18	62.5	27.5	24

45° Угольник PN25 | PN25 كوع 45° درجة

Code	Size (ø)	D1	E	Packing Unit/pcs
DIR-200045	20	19.5	14.5	500
DIR-250045	25	24.5	16	300
DIR-320045	32	31.5	18	125
DIR-400045	40	39.4	20.5	80
DIR-500045	50	49.4	23.5	40
DIR-630045	63	62.5	27.5	20
DIR-750045	75	74.2	31	15
DIR-900045	90	89.2	35.5	8
DIR-110045	110	109	41.5	4

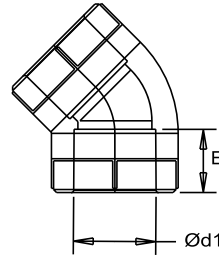

45° ELBOW



45° Угольник переходной внутр./наруж. PN25 | PN25 كوع 45° درجة

Code	Size (ø)	Ø d1	Ø d2	E	Packing Unit/pcs
KDR-200045	20	19.5	20.3	14.5	300
KDR-250045	25	24.5	25.3	16	200
KDR-320045	32	31.5	32.3	18	100

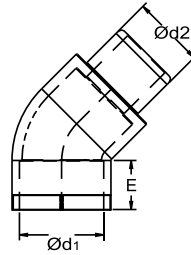

45° TAIL ELBOW



Тройник PN25 | PN25 تنى

Code	Size (ø)	Ø d1	L	E	Packing Unit/pcs
TEE-200000	20	19.5	52	14.5	250
TEE-250000	25	24.5	59	16	150
TEE-320000	32	31.5	70	18	80
TEE-400000	40	39.4	82	20.5	40
TEE-500000	50	49.4	100	23.5	25
TEE-630000	63	62.5	120	27.5	16
TEE-750000	75	74.2	137	31	10
TEE-900000	90	89.2	160	35.5	5
TEE-110000	110	109	190	41.5	2
TEE-125000	125	123.9	221	46.5	2

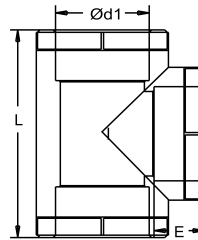

TEE



Тройник переходной PN25 | PN25 تنى منقىص

Code	Size (ø)	Ø d1	E1	Ø d2	E2	Ø d3	E3	Packing Unit/pcs
ITE-634063	63/40/63	62.5	27.5	39.4	20.5	62.5	27.5	16
ITE-635063	63/50/63	62.5	27.5	49.4	23.5	62.5	27.5	16
ITE-752075	75/20/75	74.2	31	19.5	14.5	74.2	31	10
ITE-752575	75/25/75	74.2	31	24.5	16	74.2	31	10
ITE-753275	75/32/75	74.2	31	31.5	18	74.2	31	10
ITE-754075	75/40/75	74.2	31	39.4	20.5	74.2	31	10
ITE-755075	75/50/75	74.2	31	49.4	23.5	74.2	31	10
ITE-756375	75/63/75	74.2	31	62.5	27.5	74.2	31	10
ITE-902590	90/25/90	89.2	35.5	24.5	16	89.2	35.5	5
ITE-903290	90/32/90	89.2	35.5	31.5	18	89.2	35.5	5
ITE-904090	90/40/90	89.2	35.5	39.4	20.5	89.2	35.5	5
ITE-905090	90/50/90	89.2	35.5	49.4	23.5	89.2	35.5	5
ITE-906390	90/63/90	89.2	35.5	62.5	27.5	89.2	35.5	5
ITE-907590	90/75/90	89.2	35.5	74.2	31	89.2	35.5	5
ITE-113211	110/32/110	109	41.5	31.5	18	109	41.5	2
ITE-114011	110/40/110	109	41.5	39.4	20.5	109	41.5	2
ITE-115011	110/50/110	109	41.5	49.4	23.5	109	41.5	2
ITE-116311	110/63/110	109	41.5	62.5	27.5	109	41.5	2
ITE-117511	110/75/110	109	41.5	74.2	31	109	41.5	2
ITE-119011	110/90/110	109	41.5	89.2	35.5	109	41.5	2
ITE-121112	125/110/125	123.9	46.5	109	41.5	123.9	46.5	2

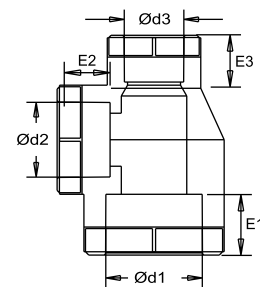

REDUCER TEE



RADIATOR BYPASS

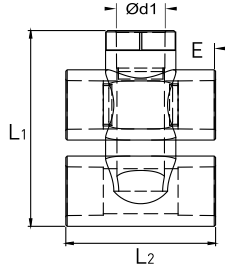

Байпас радиаторный PN25 | قطعہ توزیع المشعات PN25

Code	Size (ø)	Ø d1	E	L1	L2	Packing Unit/pcs
RBS-202000	20/20	19.5	14.5	78.3	60	100
RBS-252500	25/25	24.5	16	93	70	60

CROSS

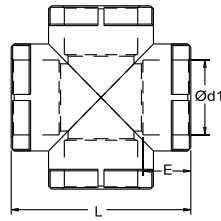

Крестовина PN25 | تى مصطب PN25

Code	Size (ø)	Ø d1	E	L	Packing Unit/pcs
IST-200000	20	19.5	14.5	50	200
IST-250000	25	24.5	16	55	125
IST-320000	32	31.5	18	60	60
IST-400000	40	39.4	20.5	86	40

REDUCER CROSS

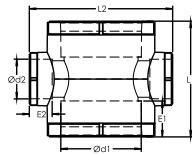

Крестовина переходная PN25 | تى منقص PN25

Code	Size (ø)	Ød1	Ød2	E1	E2	L1	L2	Packing Unit/pcs
IIS-252000	25/20	24.5	19.5	16.0	14.5	56	56	150
IIS-322500	32/25	31.5	24.5	18	16.0	70	70	75
IIS-403200	40/32	39.4	31.5	20.5	18	86	86	40
IIS-502000	50/20	49.4	19.5	23.5	14.5	84	95	30
IIS-502500	50/25	49.4	24.5	23.5	16	84	95	30
IIS-503200	50/32	49.4	31.5	23.5	18	114	95	25
IIS-504000	50/40	49.4	39.4	23.5	20.5	114	95	25
IIS-632000	63/20	62.5	19.5	27.5	14.5	91	111	16
IIS-632500	63/25	62.5	24.5	27.5	16	91	111	16
IIS-633200	63/32	62.5	31.5	27.5	18	127	113	16
IIS-634000	63/40	62.5	39.4	27.5	20.5	127	113	16
IIS-635000	63/50	62.5	49.4	27.5	23.5	127	113	12

CORNER CROSS

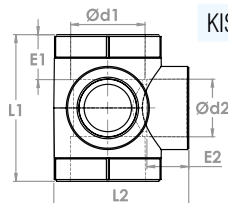
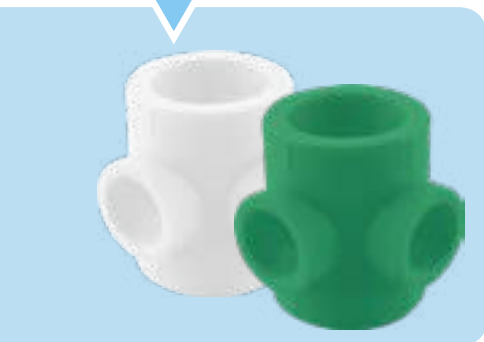

Крестовина угловая PN25 | قطعہ توزیع زوايه PN25

Code	Size (ø)	Ød1	Ød2	E1	E2	L1	L2	Packing Unit/pcs
KIS-322000	32/20	31.5	19.5	18	14.5	62	57	80
KIS-322500	32/25	31.5	24.5	18	16	62	57	80
KIS-402000	40/20	39.4	19.5	20.5	14.5	66	60	60
KIS-402500	40/25	39.4	24.5	20.5	16	66	60	60

Заглушка PN25 | PN25 سدة التحميم

Code	Size (ϕ)	ϕ d1	E	Packing Unit/pcs
KPB-200000	20	19.5	14.5	750
KPB-250000	25	24.5	16	500
KPB-320000	32	31.5	18	250
KPB-400000	40	39.4	20.5	150
KPB-500000	50	49.4	23.5	80
KPB-630000	63	62.5	27.5	50
KPB-750000	75	74.2	31	25
KPB-900000	90	89.2	35.5	18
KPB-110000	110	109	41.5	9
KPB-125000	125	123.9	46.5	6

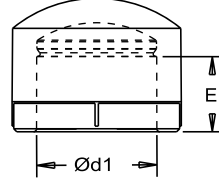

STOPEND

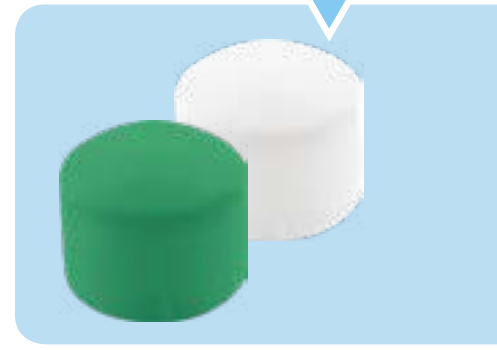

Адаптор для фланца | سدة التحميم

Code	Size (ϕ)	ϕ d1	ϕ d2	E	L	Packing Unit/pcs
FLA-500000	50	49.4	65	23.5	32	80
FLA-630000	63	62.5	80	27.5	40	50
FLA-750000	75	74.2	95	31	40	40
FLA-900000	90	89.2	111	35.5	42	25
FLA-110000	110	109	132	41.5	49	12

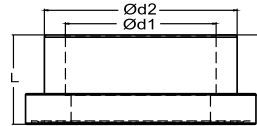

FLANGE ADAPTOR



Фланец | فلانش

Code	Size (ϕ)	ϕ d1	ϕ d2	L	Packing Unit/pcs
FLN-500000	50	66	17	109	30
FLN-630000	63	81	17	121	30
FLN-750000	75	97	17	144	16
FLN-900000	90	113	17	160	16
FLN-110000	110	133	17	180	12

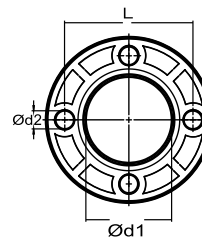

FLANGE

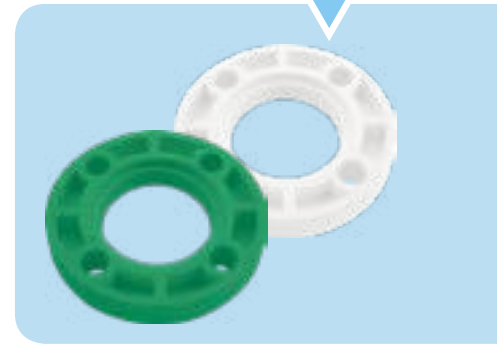

Заглушка с резьбой (Длинная) PN25 | PN25 سدة بسن دكر طويل

Code	Size (ϕ)	ϕ d	L	E	Packing Unit/pcs
UKT-200012	20 x 1/2"	20.3	56	5	750

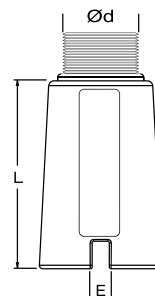

END PLUG - LONG



Available Colours

END PLUG

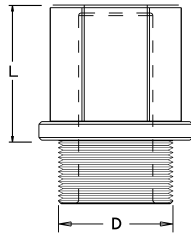

Заглушка с резьбой PN25 | PN25 سادة بسن دكر قصير

Code	Size (ø)	D	L	Packing Unit/pcs
KTP-200012	20 x 1/2"	20.3	25	2500
KTP-250034	25 x 3/4"	26	15	2500

RULER

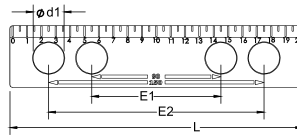
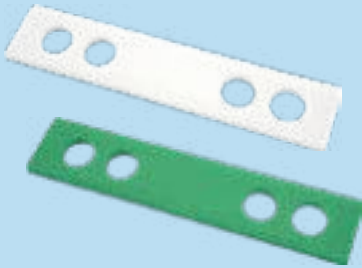

Lineyka | مسطرة

Code	Size (ø)	Ø d1	E1	E2	L	Packing Unit/pcs
CTV-000000	1/2"	20.5	90	150	200	400

MALE CROSS

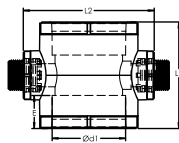

Крестовина HP | صليب بسن خارجي

Code	Size (ø)	Ø d1	E	L1	L2	Packing Unit/pcs
EIM-500012	50 x 1/2"	49.4	23.5	84	95	16
EIM-500034	50 x 3/4"	49.4	23.5	84	95	16
EIM-500100	50 x 1"	49.4	23.5	114	95	16
EIM-500114	50 x 1 1/4"	49.4	23.5	114	95	12
EIM-630012	63 x 1/2"	62.5	27.5	91	111	8
EIM-630034	63 x 3/4"	62.5	27.5	91	111	8
EIM-630100	63 x 1"	62.5	27.5	127	113	8
EIM-630114	63 x 1 1/4"	62.5	27.5	127	120	6

FEMALE CROSS

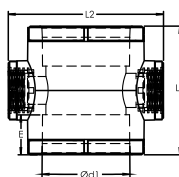

Крестовина BP PN25 | PN25 صليب بسن داخلي

Code	Size (ø)	Ø d1	E	L1	L2	Packing Unit/pcs
DIM-250012	25 x 1/2"	24.5	16	56	56	80
DIM-320034	32 x 3/4"	31.5	18	70	70	40
DIM-400034	40 x 3/4"	39.4	20.5	86	86	20
DIM-400100	40 x 1"	39.4	20.5	86	86	20
DIM-500012	50 x 1/2"	49.4	23.5	84	95	16
DIM-500034	50 x 3/4"	49.4	23.5	84	95	16
DIM-500100	50 x 1"	49.4	23.5	114	95	16
DIM-500114	50 x 1 1/4"	49.4	23.5	114	95	12
DIM-630012	63 x 1/2"	62.5	27.5	91	111	8
DIM-630034	63 x 3/4"	62.5	27.5	91	111	8
DIM-630100	63 x 1"	62.5	27.5	127	113	8
DIM-630114	63 x 1 1/4"	62.5	27.5	127	120	6



Вварное седло PN25 | وصل تلجيم الطرفين على الانبوب PN25

Code	Size (ø)	Ø d1	D	L	E	Packing Unit/pcs
KBP-200000	20	19.5	20.3	22	14.5	300
KBP-250000	25	24.5	25.3	25	16	200
KBP-320000	32	31.5	32.3	30	18	100

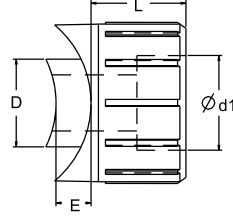

SADDLE



Вварное седло с наружной резьбой PN25 | وصلة بسن دكر PN25

Code	Size (ø)	D	L	E	Packing Unit/pcs
EKB-200012	20 x 1/2"	20.3	40	14.5	150
EKB-250034	25 x 3/4"	25.3	42	16	100
EKB-320100	32 x 1	32.3	44	18	50

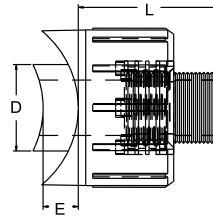

SADDLE MALE

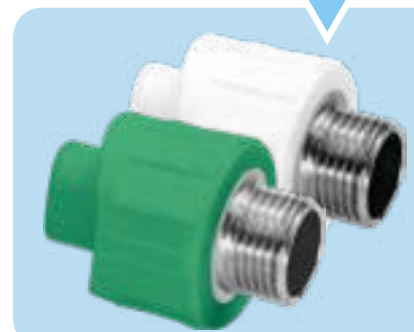

Вварное седло с внутренней резьбой PN25 | وصله تلجيم انثى مع الانبوب PN25

Code	Size (ø)	D	L	E	Packing Unit/pcs
DKB-200012	20 x 1/2"	20.3	22	14.5	150
DKB-250034	25 x 3/4"	25.3	25	16	100
DKB-320100	32 x 1	32.3	30	18	50

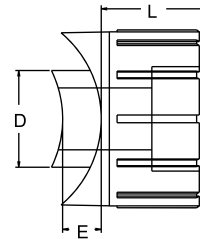

SADDLE FEMALE



Муфта комбинированная НР Круглая PN25 | محول دكر PN25

Code	Size (ø)	Ø d1	E	L	Packing Unit/pcs
EDN-200012	20 x 1/2"	19.5	14.5	48	150
EDN-250012	25 1/2"	24.5	16	56	100

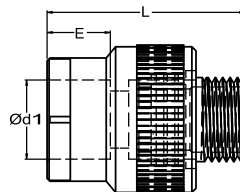

MALE NIPPLE ROUNDED



MALE NIPPLE PN 25

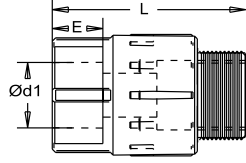

Муфта комбинированная HP PN25 | PN25 محول دكر

Code	Size (σ)	Ø d1	L	E	Packing Unit/pcs
ENP-200012	20 x 1/2"	19.5	55	14.5	125
ENP-200034	20 x 3/4"	19.5	55	14.5	100
ENP-250012	25 x 1/2"	24.5	57	16	100
ENP-250034	25 x 3/4"	24.5	57	16	80
ENP-250100	25 x 1"	24.5	57	16	50
ENP-320012	32 x 1/2"	31.5	60	18	50
ENP-320034	32 x 3/4"	31.5	60	18	60
ENP-320100	32 x 1"	31.5	60	18	60

MALE NIPPLE HEXAGONAL

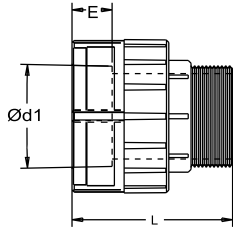

Муфта комбинированная HP под ключ PN25 | PN25 وصلة دكر بسن سداسية الشكل

Code	Size (σ)	Ø d1	L	E	Packing Unit/pcs
AEN-320100	32 x 1"	31.5	59	18	50
AEN-400100	40 x 1"	39.4	75	20.5	30
AEN-400114	40 x 1 1/4"	39.4	80	20.5	30
AEN-500112	50 x 1 1/2"	49.4	90	23.5	15
AEN-630200	63 x 2"	62.5	95	27.5	10
AEN-750212	75 x 2 1/2"	74.2	105	31	6
AEN-900300	90 x 3"	89.2	120	35.5	4
AEN-110400	110 x 4"	109	130	41.5	2
AEN-125500	125 x 5"	123.9	140	46.5	2

FEMALE NIPPLE

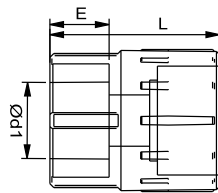

Муфта комбинированная BP PN25 | PN25 وصلة بسن انثى

Code	Size (σ)	Ø d1	L	E	Packing Unit/pcs
DNP-200012	20 x 1/2"	19.5	40	14.5	125
DNP-200034	20 x 3/4"	19.5	40	14.5	125
DNP-250012	25 x 1/2"	24.5	42	16	125
DNP-250034	25 x 3/4"	24.5	42	16	100
DNP-250100	25 x 1"	24.5	42	16	50
DNP-320012	32 x 1/2"	31.5	44	18	75
DNP-320034	32 x 3/4"	31.5	44	18	50
DNP-320100	32 x 1"	31.5	44	18	75

FEMALE NIPPLE ROUNDED

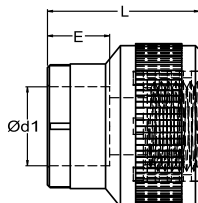

Муфта комбинированная BP Круглая PN25 | PN25 وصلة بسن انثى

Code	Size (σ)	Ø d1	L	E	Packing Unit/pcs
DDN-200012	25 x 1/2"	19.5	38	14.5	125
DDN-250012	25 x 1/2"	24.4	43	16	100

Муфта комбинированная ВР под ключ PN25 | PN25 وصله بسن انثى بشكل سداسيه

Code	Size (ø)	Ø d1	L	E	Packing Unit/pcs
ADN-320100	32 x 1"	31.5	55	18	60
ADN-400100	40 x 1"	39.4	60	20.5	30
ADN-400114	40 x 1 1/4"	39.4	65	20.5	30
ADN-500112	50 x 1 1/2"	49.4	70	23.5	20
ADN-630200	63 x 2"	62.5	75	27.5	10
ADN-750212	75 x 2 1/2"	74.2	80	31	8
ADN-900300	90 x 3"	89.2	105	35.5	6
ADN-110400	110 x 4"	109	110	41.5	2
ADN-125500	125 x 5"	123.9	130	46.5	2

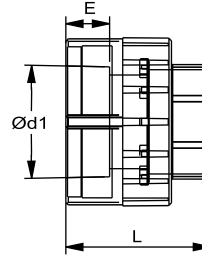

FEMALE NIPPLE HEXAGONAL



Угольник комбинированный HP PN25 | PN25 كوع بسن دكر

Code	Size (ø)	Ø d1	L	E	Packing Unit/pcs
EDR-200012	20 x 1/2"	19.5	35	14.5	100
EDR-200034	20 x 3/4"	19.5	35	14.5	75
EDR-250012	25 x 1/2"	24.5	40	16	100
EDR-250034	25 x 3/4"	24.5	40	16	75
EDR-320012	32 x 1/2"	31.5	45	18	30
EDR-320034	32 x 3/4"	31.5	45	18	30
EDR-320100	32 x 1"	31.5	45	18	30

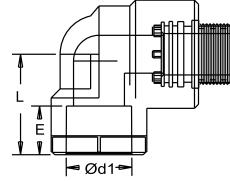

MALE ELBOW



Угольник комбинированный HP под ключ PN25 | PN25 كوع بسن الدكر سداسي الشكل

Code	Size (ø)	Ø d1	L	E	Packing Unit/pcs
AED-320100	32 x 1"	31.5	38.5	18	30
AED-400114	40 x 1 1/4"	39.4	48.5	20.5	20
AED-500112	50 x 1 1/2"	49.4	59	23.5	12
AED-630200	63 x 2"	62.5	76.5	27.5	6

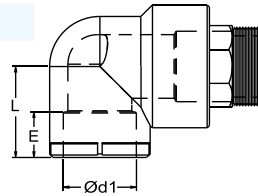

MALE ELBOW HEXAGONAL

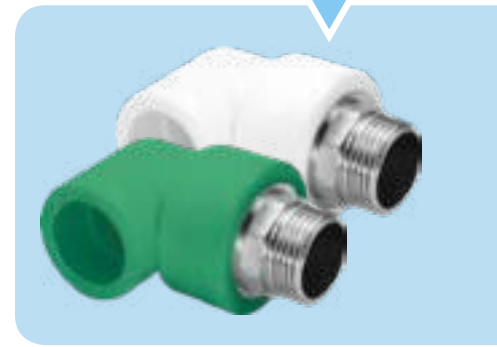

Угольник комбинированный ВР PN25 | PN25 كوع بسن داخلي انثى

Code	Size (ø)	Ø d1	L	E	Packing Unit/pcs
DDR-200012	20 x 1/2"	19.5	35	14.5	125
DDR-200034	20 x 3/4"	19.5	35	14.5	80
DDR-250012	25 x 1/2"	24.5	40	16	100
DDR-250034	25 x 3/4"	24.5	40	16	80
DDR-320012	32 x 1/2"	31.5	45	18	30
DDR-320034	32 x 3/4"	31.5	45	18	30
DDR-320100	32 x 1"	31.5	45	18	30

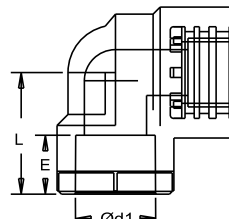

FEMALE ELBOW



FEMALE ELBOW HEXAGONAL PN 25

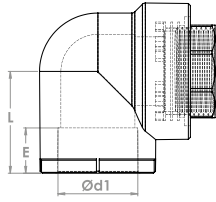

Угольник комбинированный ВР под ключ PN25 | PN25 كوع بسن انثى سداسية الشكل

Code	Size (ø)	Ø d1	L	E	Packing Unit/pcs
ADD-320100	32 x 1"	31.5	38.5	18	30
ADD-400114	40 x 1 1/4"	39.4	48.5	20.5	20
ADD-500112	50 x 1 1/2"	49.4	59	23.5	12
ADD-630200	63 x 2"	62.5	76.5	27.5	8

FEMALE BATTERY TRIPLE CONNECTION

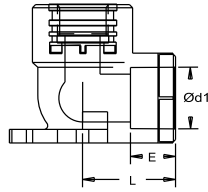

Уголок для смесителя ВР Особый PN25 | PN25 كوع بنهية الخط انثى

Code	Size (ø)	Ø d1	L	E	Packing Unit/pcs
3DB-200012	20 x 1/2"	19.5	30	14.5	75
3DB-250012	25 x 1/2"	24.5	33	16	60

MALE BATTERY TRIPLE CONNECTION PN 25

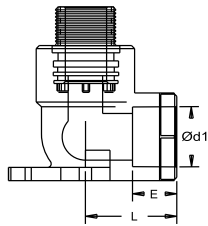

Уголок для смесителя НР Особый PN25 | PN25 كوع نهاية الخط ذكر

Code	Size (ø)	Ø d1	L	E	Packing Unit/pcs
3EB-200012	20 x 1/2"	19.5	30	14.5	60
3EB-250012	25 x 1/2"	24.5	33	16	50

FEMALE BATTERY

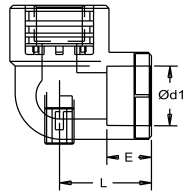

Уголок для смесителя ВР PN25 | PN25 قاعده الخياط للظهاره سن داخلي سم

Code	Size (ø)	Ø d1	L	E	Packing Unit/pcs
2DB-250034	25 x 3/4"	24.5	40	16	60

FEMALE BATTERY BYPASS

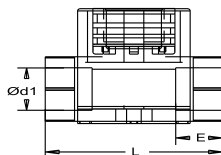

Обходной уголок для смесителя PN25 | PN25 كوع نهاية الخط انثى مزدوج

Code	Size (ø)	Ø d1	L	E	Packing Unit/pcs
GBT-200012	20 x 1/2"	19.5	60	14.5	50



Планка для смесителя BP PN25 | قاعدة الخلاط بسن الداخلي PN25

Code	Size (ø)	Ø d1	L	E	Packing Unit/pcs
CBT-200012	20 x 1/2"	19.5	150	14.5	25
CBT-250012	25 x 1/2"	24.5	150	16	20

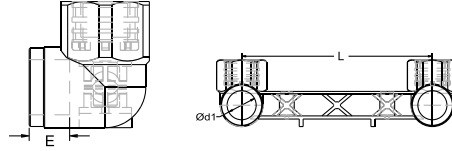

FEMALE DOUBLE BATTERY CONNECTION

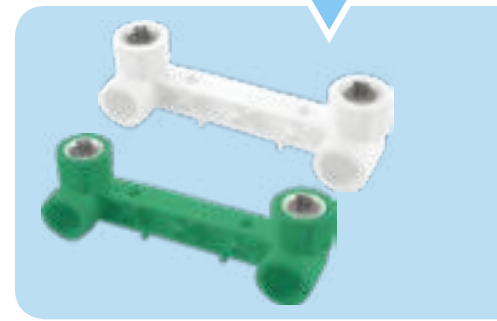

Планка для смесителя HP PN25 | قاعدة الخلاط بسن الخارجي PN25

Code	Size (ø)	Ø d1	L	E	Packing Unit/pcs
ECB-200012	20 x 1/2"	19.5	150	14.5	20
ECB-200034	20 x 3/4"	19.5	150	14.5	20
ECB-250012	25 x 1/2"	24.5	150	16	20
ECB-250034	25 x 3/4"	24.5	150	16	20

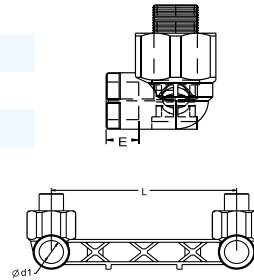

MALE DOUBLE BATTERY CONNECTION

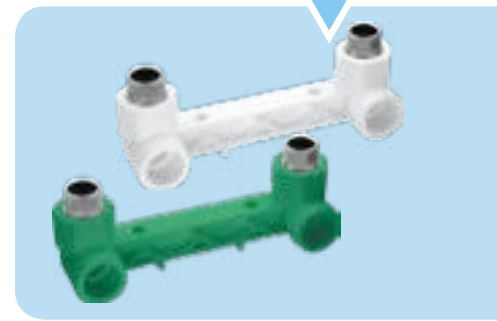

Планка для смесителя BP Плоская PN25 | قاعدة الخلاط بسن الداخلي PN25

Code	Size (ø)	Ø d1	L	E	Packing Unit/pcs
DBU-200012	20 x 1/2"	19.5	150	14.5	25
DBU-200034	20 x 3/4"	19.5	150	14.5	25
DBU-250012	25 x 1/2"	24.5	150	16	20
DBU-250034	25 x 3/4"	24.5	150	16	20

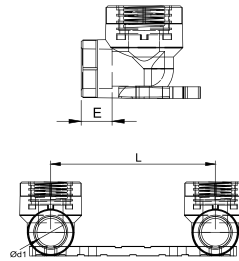

FEMALE DOUBLE BATTERY CONNECTION - SLAB

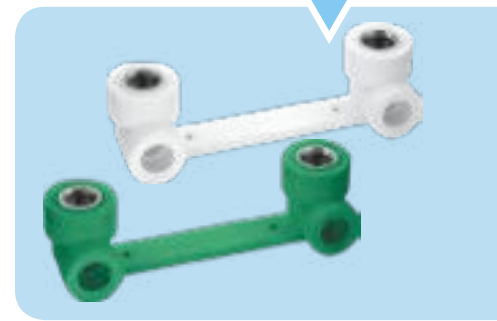

Планка для смесителя HP Плоская PN25 | قاعدة الخلاط بسن الخارجي PN25

Code	Size (ø)	Ø d1	L	E	Packing Unit/pcs
EBU-200012	20 x 1/2"	19.5	150	14.5	20
EBU-200034	20 x 3/4"	19.5	150	14.5	20
EBU-250012	25 x 1/2"	24.5	150	16	20
EBU-250034	25 x 3/4"	24.5	150	16	20

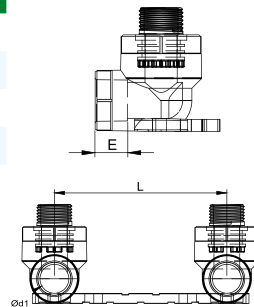

MALE DOUBLE BATTERY CONNECTION - SLAB

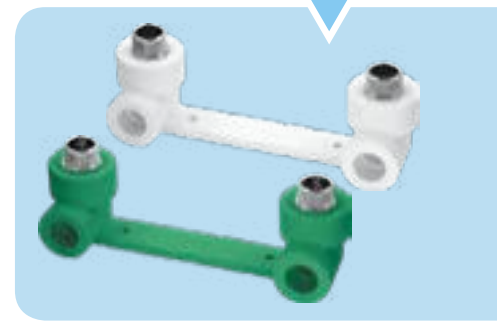

Комплект универсальный настенный PN25 | قاعدة خلاط متحرك PN25

Code	Size (ø)	Ø d1	L1	L2	L3	E	Packing Unit/pcs
ABT-200012	20 x 1/2"	19.5	105	135	150	14.5	15
ABT-250012	25 x 1/2"	24.5	105	135	150	16	15

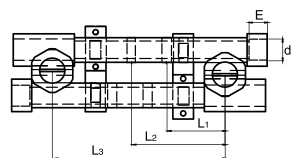

ADJUSTABLE BATTERY

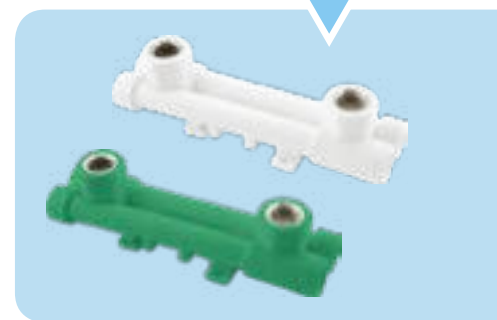

FEMALE BIDET BATTERY - DUAL

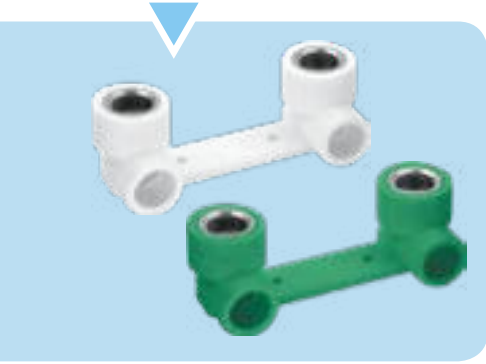

Планка для смесителя ВР Особый двойной PN25 | قاعدة الخلاط للطهارة سن داخلي 10 سم PN25

Code	Size (ø)	Ø d1	L	E	Packing Unit/pcs
DBK-200012	20 x 1/2"	19.5	100	14.5	30
DBK-250012	25 x 1/2"	24.5	100	16	25
DBK-250034	25 x 3/4"	24.5	100	16	25

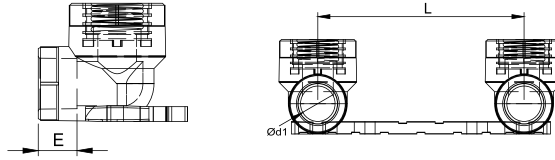

MALE BIDET BATTERY - DUAL



Планка для смесителя НР Особый двойной PN25 | قاعدة الخلاط للطهارة سن خارجي 10 سم PN25

Code	Size (ø)	Ø d1	L	E	Packing Unit/pcs
EBK-200012	20 x 1/2"	19.5	100	14.5	30
EBK-200034	20 x 3/4"	19.5	100	14.5	30
EBK-250012	25 x 1/2"	24.5	100	16	25
EBK-250034	25 x 3/4"	24.5	100	16	25

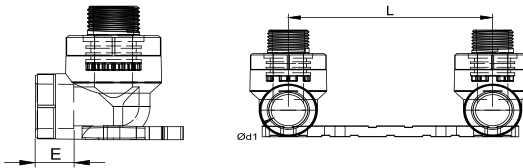

FEMALE BIDET BATTERY

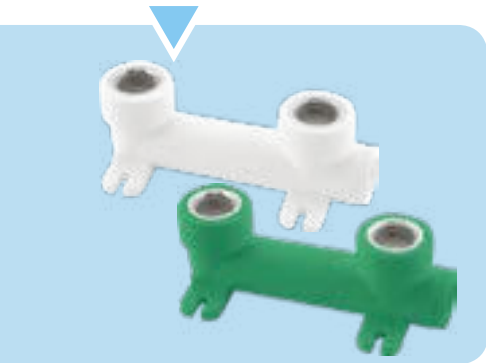

Планка для смесителя ВР Особый PN25 | قاعدة الخلاط للطهارة سن داخلي 10 سم PN25

Code	Size (ø)	Ø d1	L	E	Packing Unit/pcs
DTB-200012	20 x 1/2"	19.5	90	14.5	35
DTB-250012	25 x 1/2"	24.5	90	16	25

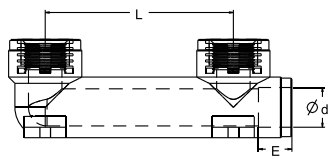

MALE BIDET BATTERY



Планка для смесителя НР Особый PN25 | قاعدة الخلاط للطهارة سن خارجي 10 سم PN25

Code	Size (ø)	Ø d1	L	E	Packing Unit/pcs
ETB-200012	20 x 1/2"	19.5	90	14.5	30
ETB-250012	25 x 1/2"	24.5	90	16	25

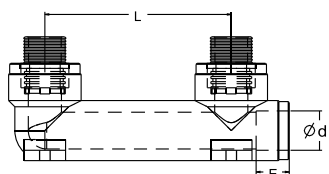

Тройник комбинированный ВР PN25 | تې بېسن انځى PN25

Code	Size (ø)	Ø d1	L	E	Packing Unit/pcs
DTE-200012	20 x 1/2"	19.5	60	14.5	100
DTE-200034	20 x 3/4"	19.5	60	14.5	75
DTE-250012	25 x 1/2"	24.5	52	16	75
DTE-250034	25 x 3/4"	24.5	66	16	50
DTE-320012	32 x 1/2"	31.5	80	18	30
DTE-320034	32 x 3/4"	31.5	80	18	30
DTE-320100	32 x 1"	31.5	80	18	30
DTE-400012	40 x 1/2"	39.4	77	20.5	20
DTE-400034	40 x 3/4"	39.4	77	20.5	20
DTE-400100	40 x 1"	39.4	82	20.5	20
DTE-500012	50 x 1/2"	49.4	87	23.5	15
DTE-500034	50 x 3/4"	49.4	87	23.5	15
DTE-500100	50 x 1"	49.4	102	23.5	15
DTE-630012	63 x 1/2"	62.5	120	27.5	9
DTE-630034	63 x 3/4"	62.5	120	27.5	9
DTE-630100	63 x 1"	62.5	120	27.5	9

FEMALE TEE

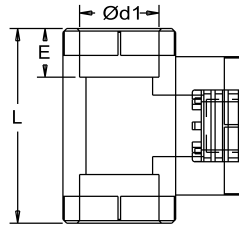

Тройник комбинированный НР PN25 | تې بېسن دكړ PN25

Code	Size (ø)	Ø d1	L	E	Packing Unit/pcs
ETE-200012	20 x 1/2"	19.5	52	14.5	100
ETE-200034	20 x 3/4"	19.5	52	14.5	75
ETE-250012	25 x 1/2"	24.5	59	16	75
ETE-250034	25 x 3/4"	24.5	59	16	50
ETE-320012	32 x 1/2"	31.5	70	18	30
ETE-320034	32 x 3/4"	31.5	44	18	30
ETE-320100	32 x 1"	31.5	44	18	30
ETE-400012	40 x 1/2"	39.4	77	20.5	20
ETE-400034	40 x 3/4"	39.4	77	20.5	20
ETE-400100	40 x 1"	39.4	82	20.5	20
ETE-500012	50 x 1/2"	49.4	87	23.5	15
ETE-500034	50 x 3/4"	49.4	87	23.5	15
ETE-500100	50 x 1"	49.4	102	23.5	15
ETE-630012	63 x 1/2"	62.5	120	27.5	8
ETE-630034	63 x 3/4"	62.5	120	27.5	8
ETE-630100	63 x 1"	62.5	120	27.5	8

MALE TEE

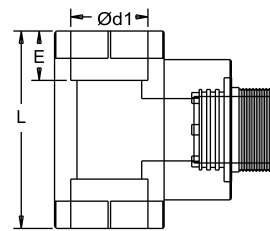

Тройник комбинированный ВР под ключ PN25 | تې بېسن انځى سداسي PN25

Code	Size (ø)	Ø d1	L	E	Packing Unit/pcs
DAT-320100	32 x 1"	31.5	80	18	30
DAT-400114	40 x 1 1/4"	39.4	97.5	20.5	20

FEMALE TEE HEXAGONAL

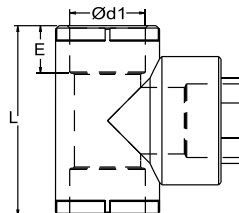

MALE TEE HEXAGONAL

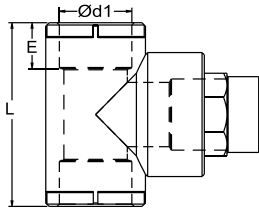

Тройник комбинированный НР под ключ PN25 | PN25 تي بسن انشئ سداسي

Code	Size (ø)	Ø d1	L	E	Packing Unit/pcs
EAT-320100	32 x 1"	31.5	70	18	30
EAT-400114	40 x 1 1/4"	39.4	97.5	20.5	15

BALL VALVE

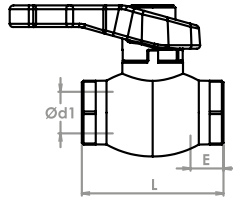

Пластиковый шаровой кран PN25 | PN25 محبس كروي بلاستيكي

Code	Size (ø)	Ø d1	L	E	Packing Unit/pcs
KSV-200012	20	19.5	66	14.5	50
KSV-250034	25	24.5	73	16	40
KSV-320100	32	31.5	88	18	20
KSV-400114	40	39.4	105	20.5	12
KSV-500112	50	49.4	125	23.5	8
KSV-630200	63	62.5	150	27.5	4
KSV-750212	75	74.2	165	31	4

BALL VALVE (EKO)

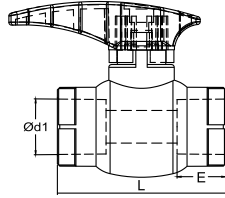

Пластиковый шаровой кран EKO PN25 | PN25 محبس كروي بلاستيكي اكنومي

Code	Size (ø)	Ø d1	L	E	Packing Unit/pcs
KVE-200000	20	19.5	59	14.5	90
KVE-250000	25	24.5	64	16	60
KVE-320000	32	31.5	75	18	40

BALL VALVE (SHORT HANDLE)

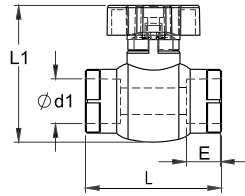

Пластиковый шаровой кран EKO PN25 | PN25 محبس كروي بلاستيكي اكنومي

Code	Size (ø)	Ø d1	L	E	Packing Unit/pcs
KVE-200000-K	20	19.5	59	14.5	90
KVE-250000-K	25	24.5	64	16	60
KVE-320000-K	32	31.5	75	18	40

BRASS BALL VALVE

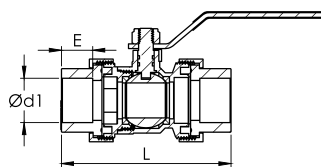

Кран латунный с американкой PN25 | PN25 صمام الكرة النحاسية

Code	Size (mm)	Ø d1	L	E	Packing Unit/pcs
PBV-200000	20	19.5	85	14.5	40
PBV-250000	25	24.5	94	16	30
PBV-320000	32	31.5	100	18	20
PBV-400000	40	39.4	116	20.5	15
PBV-500000	50	49.4	131	23.5	9
PBV-630000	63	62.5	148	27.5	4



Шаровый кран под штукатурку | محبس كروي زجت البلاط

Code	Size (ø)	Ø d1	E	L	L1	Packing Unit/pcs
SKV-200000	20	19,5	14,5	70	98	30
SKV-250000	25	24,5	16	75	102	20

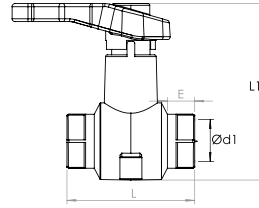

UNDERCOATING BALL VALVE



Шаровый кран с двойной раз. муфтой | محبس شد الوصل

Code	Size (ø)	Ø d1	L	E	Packing Unit/pcs
COK-200000	20	19.5	120	14.5	30
COK-250000	25	24.5	124	16	20
COK-320000	32	31.5	140	18	15

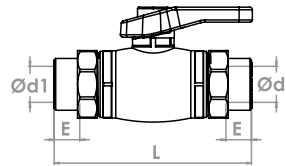

BALL VALVE WITH DOUBLE UNION



Шаровый кран ВР с раз. Муфтой PN25 | محبس شد الوصل نهاية الانثى

Code	Size (ø)	Ø d1	L	E	Packing Unit/pcs
DTV-200000	20	19.5	91	14.5	30
DTV-250000	25	24.5	95	16	25
DTV-320000	32	31.5	109	18	20

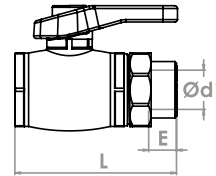

FEMALE BALL VALVE WITH SINGLE UNION



Шаровый кран с раз. Муфтой PN25 | محبس شد الوصل نهاية الانثى

Code	Size (ø)	Ø d1	L	E	Packing Unit/pcs
TOK-200000	20	19.5	91	14.5	30
TOK-250000	25	24.5	95	16	25
TOK-320000	32	31.5	109	18	20

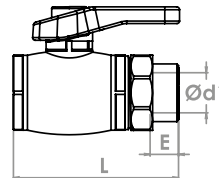

BALL VALVE WITH SINGLE UNION



Пластиковый шаровый кран ВР PN25 | محبس كروي بلاستيك

Code	Size (ø)	Ø d1	L	E	Packing Unit/pcs
DKV-200012	20 x 1/2"	19.5	64	14.5	50
DKV-250034	25 x 3/4"	24.5	67	16	40
DKV-320100	32 x 1"	31.5	78	18	20

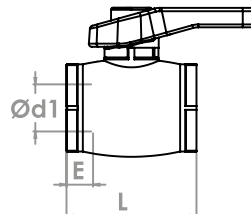

FEMALE BALL VALVE



RADIATOR VALVE STRAIGHT



Шаровый радиаторный кран прямой PN25 | محبس بلمستيك بسن الدكر

Code	Size (ø)	Ø d1	L1	L	E	Packing Unit/pcs
KRN-200012	20 x 1/2"	19.5	67	89	14.5	50
KRN-250012	25 x 1/2"	24.5	67	89	16	50
KRN-250034	25 x 3/4"	24.5	72	94	16	40

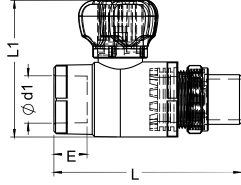

RADIATOR VALVE ELBOW



Шаровый радиаторный кран угловой PN25 | محبس بلمستيك بسن الدكر PN25

Code	Size (ø)	Ø d1	L1	L	E	Packing Unit/pcs
KRD-200012	20 x 1/2"	19.5	83	87.5	14.5	50
KRD-250012	25 x 1/2"	24.5	83	87.5	16	50
KRD-250034	25 x 3/4"	24.5	90.5	91	16	40

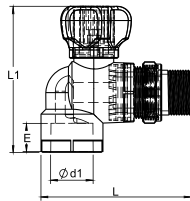

RADIATOR ADAPTOR



Муфта комбинированная разъемная для радиатора PN25 | وصلة التحويل PN25

Code	Size (ø)	Ø d1	L	E	Packing Unit/pcs
ORN-200012	20 x 1/2"	19.5	55	14.5	60
ORN-200034	20 x 3/4"	19.5	57	14.5	50
ORN-250012	25 x 1/2"	24.5	57	16	60
ORN-250034	25 x 3/4"	24.5	57	16	50

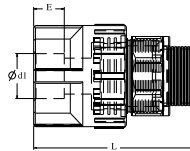

call for
**Very Fast
Delivery**



nature
series



Угольник комбинированный разъемный для радиатора PN25 | PN25 كوع زجويل

Code	Size (ø)	Ø d1	L	E	Packing Unit/pcs
ORD-200012	20 x 1/2"	19.5	30	14.5	60
ORD-200034	20 x 3/4"	19.5	35	14.5	50
ORD-250012	25 x 1/2"	24.5	40	16	60
ORD-250034	25 x 3/4"	24.5	40	16	50

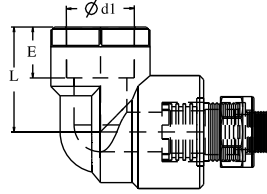

RADIATOR ELBOW ADAPTOR



Проходной вентиль PN25 | PN25 محبس بلاستيك

Code	Size (ø)	Ø d1	L	L1	E	Packing Unit/pcs
KBV-200012	20	19.5	73	96	14.5	40
KBV-250034	25	24.5	73	105	16	30
KBV-320100	32	31.5	86	109	18	20
KBV-400114	40	39.4	93	129	20.5	15

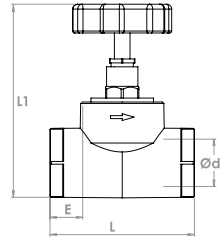

BUTTERFLY VALVE



Вентиль PN25 | PN25 محبس طهارة

Code	Size (ø)	Ø d1	L	L1	E	Packing Unit/pcs
LSV-200000	20	19.5	73	138	14.5	15
LSV-250000	25	24.5	78	138	16	15
LSV-320000	32	31.5	87	143	18	15

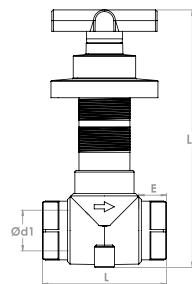

NEW

LUSTRATION VALVE



Вентиль хромированный со встроенной ручкой PN25 | PN25 محبس مخبي

Code	Size (ø)	Ø d1	L	L1	E	Packing Unit/pcs
KAV-200012	20	19.5	73	93	14.5	30
KAV-250034	25	24.5	73	94	16	25
KAV-320100	32	31.5	86	105	18	25
KAV-400114	40	39.4	93	107	20.5	20

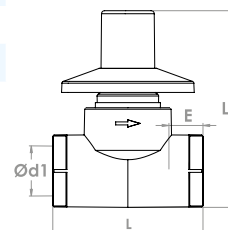

CHROME VALVE plastic encastre



CHROME VALVE plastic head

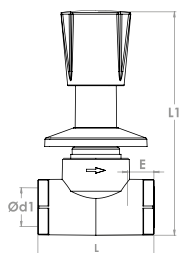

Вентиль с хромированной треугольной ручкой PN25 | PN25 محبس كروم مثلث

Code	Size (ø)	Ø d1	L	L1	E	Packing Unit/pcs
KVZ-200012	20	19.5	73	137	14.5	25
KVZ-250034	25	24.5	73	140	16	20
KVZ-320100	32	31.5	86	150	18	15
KVZ-400114	40	39.4	93	156	20.5	10

CHROME VALVE TRIANGLE plastic head

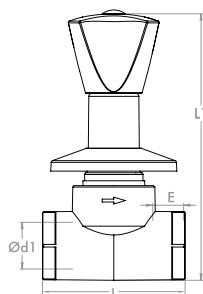

Вентиль с хромированной треугольной ручкой PN25 | PN25 محبس كروم مثلث

Code	Size (ø)	Ø d1	L	L1	E	Packing Unit/pcs
KVZ-200012-M	20	19.5	73	130	14.5	25
KVZ-250034-M	25	24.5	73	136	16	20
KVZ-320100-M	32	31.5	86	146	18	15
KVZ-400114-M	40	39.4	93	152	20.5	10

CHROME BALL VALVE plastic head

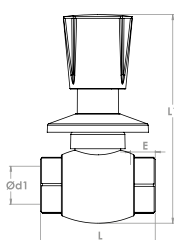

Шаровый кран с хромированной треугольной ручкой PN25 | PN25 محبس كروي مثلث

Code	Size (ø)	Ø d1	L	L1	E	Packing Unit/pcs
KKV-200012	20	19.5	67	132	14.5	25
KKV-250034	25	24.5	74	138	16	20
KKV-320100	32	31.5	87	150	18	15

CHROME BALL VALVE TRIANGLE plastic head

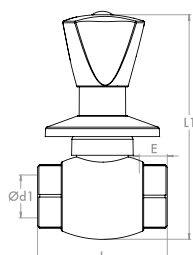

Шаровый кран с хромированной треугольной ручкой PN25 | PN25 محبس كروي مثلث

Code	Size (ø)	Ø d1	L	L1	E	Packing Unit/pcs
KKV-200012-M	20	19.5	67	126	14.5	25
KKV-250034-M	25	24.5	74	133	16	20
KKV-320100-M	32	31.5	87	148	18	15

محبس غسالات

Code	Size (ϕ)	L	L1	Packing Unit/pcs
CMS-200000	1/2"-25mm	72	39	40

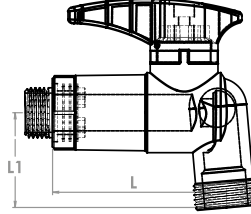

WASHING MACHINE TAP



محبس حديقة

Code		Size (ϕ)	L	L1	Packing Unit/pcs
BMS-200012	Thin Hose	1/2"	74	63	40
BMS-200058	Thick Hose	5/8"	74	63	40

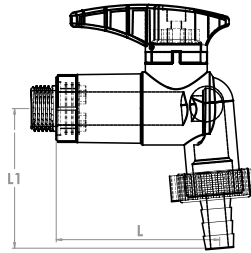

GARDEN TAP



Code	Size (ϕ)	Packing Unit/pcs
MCT-000034	3/4"	100

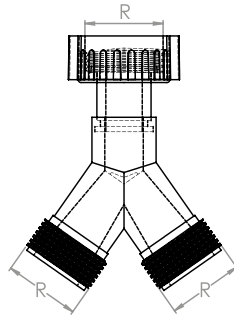

TWIN TAP



Обратный клапан HP PN25 | صمام عكسي PN25

Code	Size (ϕ)	ϕ d1	ϕ d2	L	E	Packing Unit/pcs
VEF-200012	20	19.5	20.3	67	14.5	75
VEF-250034	25	24.5	25.3	71	16	50
VEF-320100	32	31.5	32.3	100	18	25

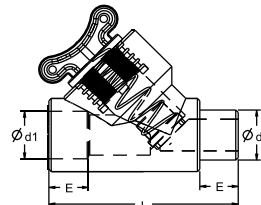

NON RETURN VALVE MALE



NON RETURN VALVE FEMALE

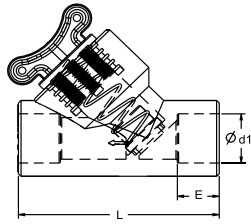

Обратный клапан ВР PN25 | صمام مصفى PN25

Code	Size (ø)	Ø d1	L	E	Packing Unit/pcs
VDF-200012	20	19.5	67	14.5	75
VDF-250034	25	24.5	71	16	50
VDF-320100	32	31.5	100	18	25

VALVE MALE

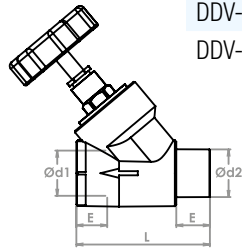

Проходной вентиль внутр./наруж. PN25 | صمام مصفى PN25

Code	Size (ø)	Ø d1	Ø d2	L	E	Packing Unit/pcs
DDV-200012	20	19.5	20.3	78	14.5	30
DDV-250034	25	24.5	25.3	88	16	30
DDV-320100	32	31.5	32.3	106	18	15

VALVE FEMALE

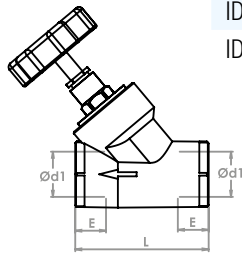

Проходной вентиль внутр./внутр. PN25 | صمام مصفى PN25

Code	Size (ø)	Ø d1	L	E	Packing Unit/pcs
IDV-200012	20	19.5	78	14.5	30
IDV-250034	25	24.5	88	16	30
IDV-320100	32	31.5	106	18	15

MALE FILTER

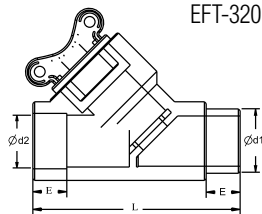

Фильтр внутр./наруж. PN25 | صمام مصفى PN25

Code	Size (ø)	Ø d1	Ø d2	L	E	Packing Unit/pcs
EFT-200012	20	20.3	19.5	78	14.5	75
EFT-250034	25	25.3	24.5	88	16	50
EFT-320100	32	32.3	31.5	106	18	25

FEMALE FILTER

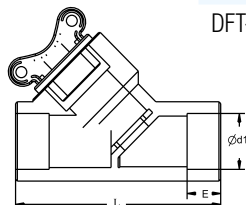

Фильтр внутр./внутр. PN25 | صمام مائل مصفى PN25

Code	Size (ø)	Ø d1	L	E	Packing Unit/pcs
DFT-200012	20	19.5	78	14.5	75
DFT-250034	25	24.5	88	16	50
DFT-320100	32	31.5	106	18	25



Муфта комбинированная НР для бойлера | محمول دكر

Code	Size (ø)	Ø d1	L	E	Packing Unit/pcs
ENK-200012	20 x 1/2"	20.3	52	14.5	125
ENK-200034	20 x 3/4"	20.3	54	14.5	100
ENK-250012	25 x 1/2"	25.3	52	16	125
ENK-250034	25 x 3/4"	25.3	54	16	75

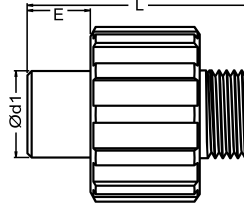

TAILED MALE NIPPLE

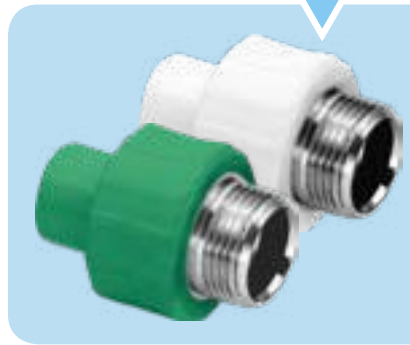

Муфта комбинированная ВР для бойлера | وصله بسن الالانش

Code	Size (ø)	Ø d1	L	E	Packing Unit/pcs
DNK-200012	20 x 1/2"	20.3	41	14.5	150
DNK-200034	20 x 3/4"	20.3	41	14.5	150
DNK-250012	25 x 1/2"	25.3	41	16	150
DNK-250034	25 x 3/4"	25.3	41	16	150

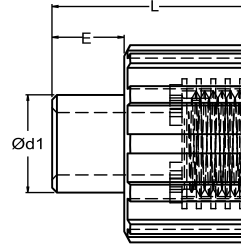

TAILED FEMALE NIPPLE



Угольник с накидной гайкой PN25 | كوع راس متحرك PN25

Code	Size (ø)	Ø d1	L	E	Packing Unit/pcs
HDR-200012	20 x 1/2"	19.5	30	14.5	120
HDR-200034	20 x 3/4"	19.5	30	14.5	80
HDR-250034	25 x 3/4"	24.5	32	16	80
HDR-250100	25 x 1"	24.5	32	16	75
HDR-320034	32 x 3/4"	31.5	38	18	50
HDR-320100	32 x 1"	31.5	38	18	50
HDR-320114	32 x 1" 1/4"	31.5	38	18	40

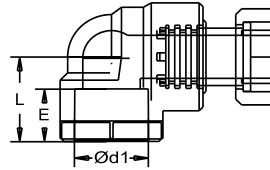

ELBOW WITH NUT



Муфта с накидной гайкой PN25 | وصل راس متحرك PN25

Code	Size (ø)	Ø d1	E	Packing Unit/pcs
HNP-200012	20 x 1/2"	19.5	14.5	175
HNP-200034	20 x 3/4"	19.5	14.5	125
HNP-250012	25 x 1/2"	24.5	16	125
HNP-250034	25 x 3/4"	24.5	16	125
HNP-250100	25 x 1"	24.5	16	80
HNP-320034	32 x 3/4"	31.5	18	75
HNP-320100	32 x 1"	31.5	18	60
HNP-320114	32 x 1" 1/4"	31.5	18	50

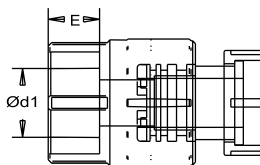

NIPPLE WITH NUT



TEE WITH NUT

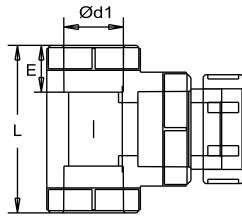

Тройник с накидной гайкой PN25 | تى وصل متحرك PN25

Code	Size (ø)	Ø d1	L	E	Packing Unit/pcs
HTE-200012	20 x 1/2"	19.5	30	14.5	125
HTE-200034	20 x 3/4"	19.5	30	14.5	80
HTE-250034	25 x 3/4"	24.5	32	16	80
HTE-250100	25 x 1"	24.5	32	16	40
HTE-320100	32 x 1"	31.5	38	18	30
HTE-320114	32 x 1 1/4"	31.5	38	18	30

TRANSITION UNION MALE

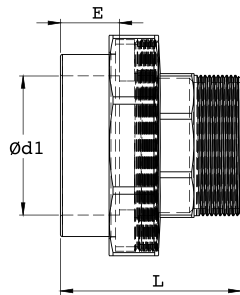

Муфта комбинированная разъемная HP PN25 | شذ وصل دكر PN25

Code	Size (ø)	Ø d1	L	E	Packing Unit/pcs
MOE-200012	20 x 1/2"	19.5	45	14.5	175
MOE-200034	20 x 3/4"	19.5	45	14.5	150
MOE-200100	20 x 1"	19.5	50	14.5	160
MOE-250012	25 x 1/2"	24.5	46	16	120
MOE-250034	25 x 3/4"	24.5	49	16	100
MOE-250100	25 x 1"	24.5	50	16	100
MOE-320012	32 x 1/2"	31.5	49	18	80
MOE-320034	32 x 3/4"	31.5	49	18	80
MOE-320100	32 x 1"	31.5	52	18	75
MOE-320114	32 x 1 1/4"	31.5	56	18	60
MOE-400114	40 x 1 1/4"	39.4	59	20.5	40
MOE-500112	50 x 1 1/2"	49.4	62	23.5	25
MOE-630200	63 x 2"	62.5	72	27.5	16
MOE-750212	75 x 2 1/2"	74.2	97	31	6
MOE-900300	90 x 3"	89.2	117	35.5	3
MOE-110400	110 x 4"	109	134	41.5	2

TRANSITION UNION FEMALE

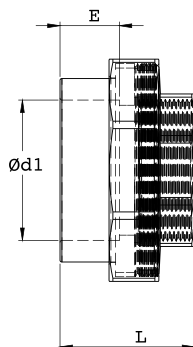

Муфта комбинированная разъемная BP PN25 | شذ وصل انثى سداسي الشكل PN25

Code	Size (ø)	Ø d1	L	E	Packing Unit/pcs
MOD-200012	20 x 1/2"	19.5	38	14.5	200
MOD-200034	20 x 3/4"	19.5	38	14.5	175
MOD-200100	20 x 1"	19.5	39	14.5	175
MOD-250012	25 x 1/2"	24.5	37	16	125
MOD-250034	25 x 3/4"	24.5	38	16	125
MOD-250100	25 x 1"	24.5	40	16	100
MOD-320012	32 x 1/2"	31.5	42	18	90
MOD-320034	32 x 3/4"	31.5	42	18	80
MOD-320100	32 x 1"	31.5	42	18	80
MOD-320114	32 x 1 1/4"	31.5	46	18	70
MOD-400114	40 x 1 1/4"	39.4	48	20.5	50
MOD-500112	50 x 1 1/2"	49.4	48	23.5	25
MOD-630200	63 x 2"	62.5	58	27.5	16
MOD-750212	75 x 2 1/2"	74.2	72	31	9
MOD-900300	90 x 3"	89.2	78	35.5	3
MOD-110400	110 x 4"	109	89	41.5	2

Штуцер с накидной гайкой HP PN25 | شذ وصل دكر PN25

Code	Size (ϕ)	ϕ d1	L	Packing Unit/pcs
ONE-200034	20 x 3/4"	20.3	38	200
ONE-250100	25 x 1"	25.3	43	150

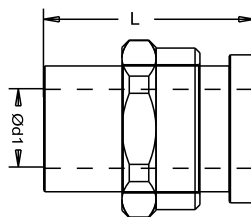

TRANSITION NIPPLE MALE

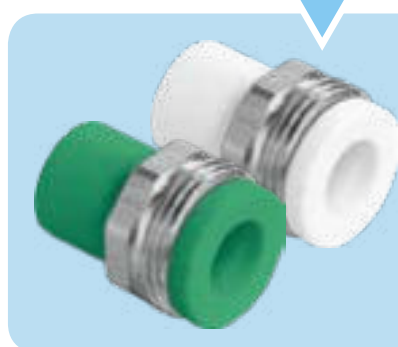

Штуцер с накидной гайкой BP PN25 | شذ وصل انثى PN25

Code	Size (ϕ)	ϕ d1	L	Packing Unit/pcs
OND-200034	20 x 3/4"	20.3	38	200
OND-250100	25 x 1"	25.3	43	150

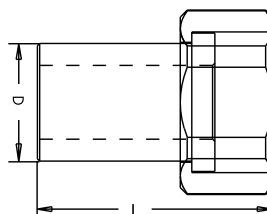

TRANSITION NIPPLE FEMALE

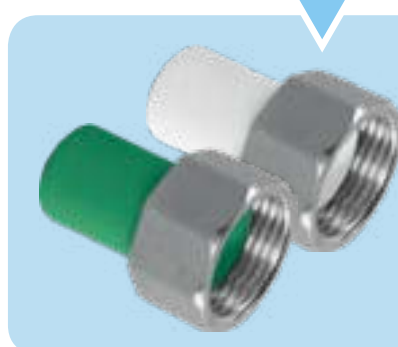

Муфта для водоизмерителя PN25 | شذ وصل انثى PN25

Code	Size (ϕ)	ϕ d1	L1	Packing Unit/pcs
SSB-200034	20 x 3/4"	20.3	68	175
SSB-250100	25 x 1"	25.3	68	150

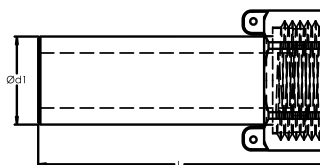

WATER METER NIPPLE

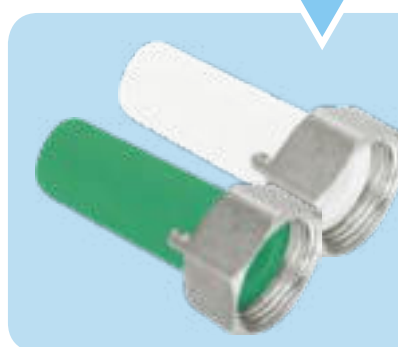

Муфта соединительная для сварки PN25 | وصل لجام الطرفين PN25

Code	Size (ϕ)	ϕ d1	E	L	Packing Unit/pcs
MCR-200000	20	19.5	14.5	56	100
MCR-250000	25	24.5	16	59	75
MCR-320000	32	31.5	18	60	50
MCR-400000	40	39.4	20.5	59	30
MCR-500000	50	49.4	23.5	59	25
MCR-630000	63	62.5	27.5	72	14

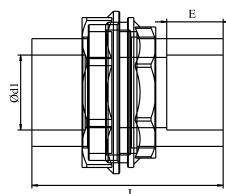

TRANSITION UNION TWO-SIDE WELDED



UNION

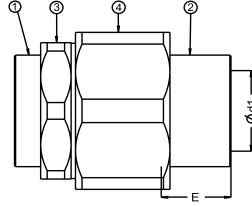

Муфта разъемная пластиковая под ключь | PN25 وصل لجام الطرفين

Code	Size (ø)	Ø d1	E	Packing Unit/pcs
CKR-200000	20	19.5	14.5	100
CKR-250000	25	24.5	16	60
CKR-320000	32	31.5	18	50

UNION

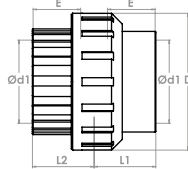

Муфта разъемная пластиковая PN16 | PN16 وصل لجام الطرفين

Code	Size (ø)	Ø d1	L1	L2	D1	Packing Unit/pcs
PKR-200000	20	19	21.5	24.3	41.6	200
PKR-250000	25	24.1	27.6	25.7	52	125
PKR-320000	32	31	25.2	30.1	58.9	80
PKR-400000	40	39.4	29	39	82	50
PKR-500000	50	49.4	34	45	92	30
PKR-630000	63	62.5	41	55	112	16
PKR-750000	75	74.9	47	53	130	10
PKR-900000	90	89.9	56	61	181	6
PKR-110000	110	110	65	71	210	3

PLASTIC TRANSITION UNION MALE

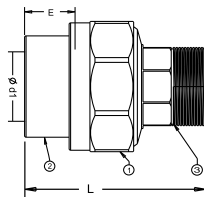

Пластиковая Разъемная муфта HP PN25 | PN25 مدحول انكس بلاستيك

Code	Size (ø)	Ø d1	E	L	Packing Unit/pcs
POE-200012	20 x 1/2"	19.5	14.5	60	100
POE-250034	25 x 3/4"	24.5	16	65	70
POE-320100	32 x 1"	31.5	18	67	50

PLASTIC TRANSITION UNION FEMALE

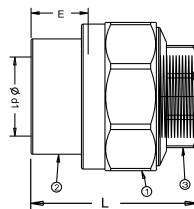

Пластиковая Разъемная муфта BP PN25 | PN25 مدحول انكس بلاستيك

Code	Size (ø)	Ø d1	E	L	Packing Unit/pcs
POD-200012	20 x 1/2"	19.5	14.5	50	100
POD-250034	25 x 3/4"	24.5	16	55	80
POD-320100	32 x 1"	31.5	18	57	60

Комплект для бойлеров с комб. муфтой PN25 | مجموعة خزان الماء PN25

Code	Box Contents	Packing Unit/pcs
KHN-080000	With Screwed Nipple (8 Pcs)	12
KHN-100000	With Screwed Nipple (10 Pcs)	12
KHD-080000	With Screwed Elbow (8 Pcs)	12
KHD-100000	With Screwed Elbow (10 Pcs)	12
KEN-080000	With Mail Nipple (8 Pcs)	12
KEN-100000	With Mail Nipple (10 Pcs)	12
KED-080000	With Mail Elbow (8 Pcs)	12
KED-100000	With Mail Elbow (10 Pcs)	12

BOILER SET

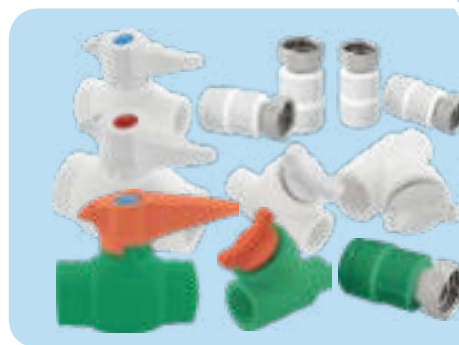

Комплект для бойлеров с комб. муфтой PN25 | مجموعة خزان الماء PN25

Code	Box Contents	Packing Unit/pcs
EKN-080000	With Screwed Nipple (8 Pcs)	12
EKN-100000	With Screwed Nipple (10 Pcs)	12
EKD-080000	With Screwed Elbow (8 Pcs)	12
EKD-100000	With Screwed Elbow (10 Pcs)	12

BOILER SET (Economic)



Муфта комбинированная наружн. для трубы PEX | نحويل

Code	Size (ø)	Ø d1	L	E	Packing Unit/pcs
SPK-201216	20x1/2x16	20.3	54	14.5	200

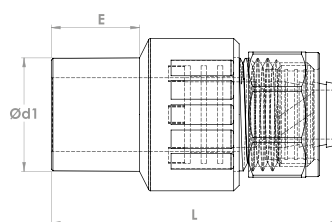

PEX TAIL ADAPTER

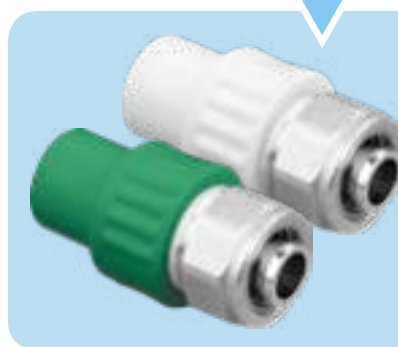

Муфта комбинированная внутр. для трубы PEX | نحويل

Code	Size (ø)	Ø d1	L	E	Packing Unit/pcs
SPD-201216	20x1/2x16	19.3	54	14.5	140

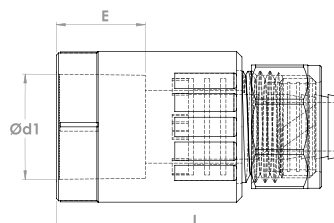

PEX FEMALE ADAPTER

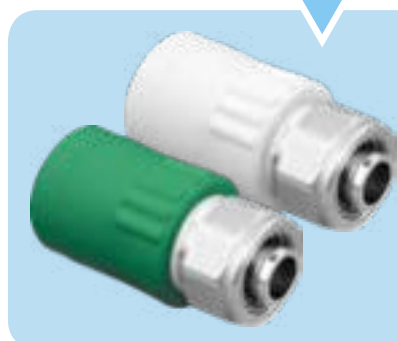

SINGLE CLAMP

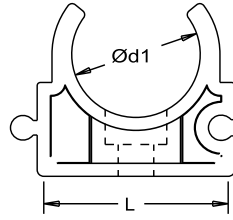

Опора | حامل الأنبوب

Code	Size (ϕ)	ϕ d1	L	Packing Unit/pcs
TKP-200000	20	20	32	3000
TKP-220000	22 Foiled Pipe	22	36	2500
TKP-250000	25	25	39	2500
TKP-270000	27 Foiled Pipe	27	41	2500
TKP-320000	32	32	46	1800
TKP-340000	34 Foiled Pipe	34	48	1500
TKP-400000	40	40	54	1400

CLAMP WITH COVER

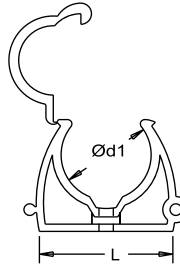

Опора с креплением | حامل الأنبوب المغلق الشاوية

Code	Size (ϕ)	ϕ d1	L	Packing Unit/pcs
KPK-160000	16	16	28	2500
KPK-200000	20	20	32	2000
KPK-220000	22 Foiled Pipe	22	34	2000
KPK-250000	25	25	37	2000
KPK-270000	27 Foiled Pipe	27	39	1500
KPK-320000	32	32	44	1000
KPK-400000	40	40	52	750
KPK-500000	50	50	62	500

DOUBLE CLAMP

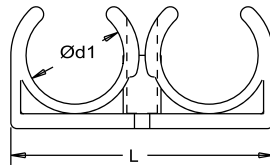

Опора двойная | اداة تثبيت الانابيب بالارض

Code	Size (ϕ)	ϕ d1	L	Packing Unit/pcs
CKP-202200	20-22	20-22	60	1800
CKP-252700	25-27	25-27	65	1500
CKP-323400	32-34	32-34	72	750

NATURAL GAS GROUNDING NIPPLE

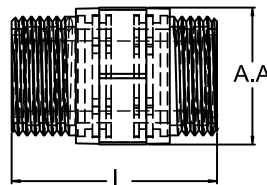

Муфта прямая диэлектрическая ш/ш ГАЗ | وصلة نحاس بسن خارجي

Code	Size (ϕ)	L1	A.A	Packing Unit/pcs
DTN-000012	1/2"	43	24	300
DTN-000034	3/4"	43	28	250

formül[®]

PP-RCT PIPES

4

PIPE S 4 - SDR 9

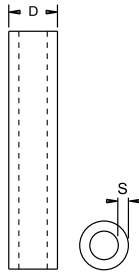
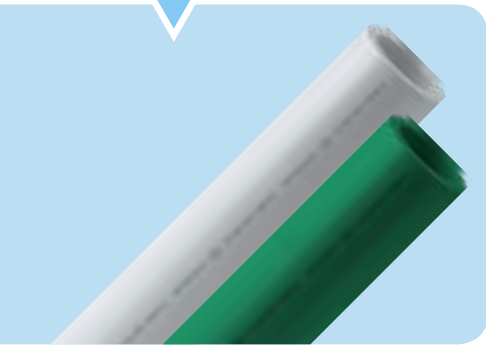

Code	Size (mm)	S	Packing Unit/mt
DUZ-200022-CT	20	2.3	140
DUZ-250022-CT	25	2.8	100
DUZ-320022-CT	32	3.6	60
DUZ-400022-CT	40	4.5	40
DUZ-500022-CT	50	5.6	24
DUZ-630022-CT	63	7.1	20
DUZ-750022-CT	75	8.4	12
DUZ-900022-CT	90	10.1	8
DUZ-110022-CT	110	12.3	4
DUZ-125022-CT	125	14.0	4

PIPE S 3,2 - SDR 7,4

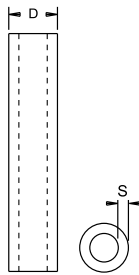
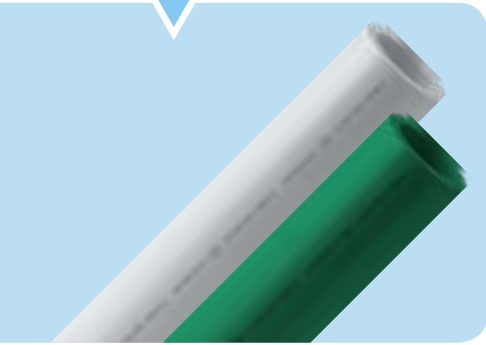

Code	Size (mm)	S	Packing Unit/mt
DUZ-200025-CT	20	2.8	140
DUZ-250025-CT	25	3.5	100
DUZ-320025-CT	32	4.4	60
DUZ-400025-CT	40	5.5	40
DUZ-500025-CT	50	6.9	24
DUZ-630025-CT	63	8.6	20
DUZ-750025-CT	75	10.3	12
DUZ-900025-CT	90	12.3	8
DUZ-110025-CT	110	15.1	4
DUZ-125025-CT	125	17.1	4

***The new generation of installation systems
for plumbing...***



formül[®]

**PE-RT PIPES
& FITTINGS**

5

PIPE



Труба PE-RT | انبوب بارت

Code	Size	Packing Unit/mt
PRT-160000	16 x 2 mm	160

PIPE IN COVER



Труба PE-RT в защитном кожухе | انبوب بارت مغلف

Code	Size	Packing Unit/mt
PRK-160000 Red	16 x 2 mm	100
PRK-160000 Blue	16 x 2 mm	100

PIPE WITH OXYGEN BARRIER



Труба PE-RT с кислородным барьером | انبوب بارت بالاكسيжан

Code	Size	Packing Unit/mt
PBR-160000	16 x 2 mm	160

PIPE WITH OXYGEN BARRIER IN COVER



Труба PE-RT с кислородным барьером в защитном кожухе | انبوب بارت مغلف بالاكسيжан

Code	Size	Packing Unit/mt
PBK-160000 Red	16 x 2 mm	100
PBK-160000 Blue	16 x 2 mm	100

Крепление с фиксатором | حاملة الأنبوب

Code	Size (ϕ)	ϕ d1	ϕ d2	E	Packing Unit/pcs
DTK-200000	20	20	8	28	2000
DTK-250000	25	25	8	28	1500
DTK-320000	32	32	8	28	1000

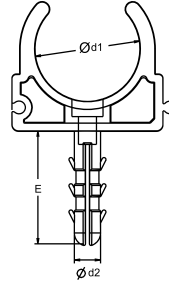

SINGLE FIXING CLAMP

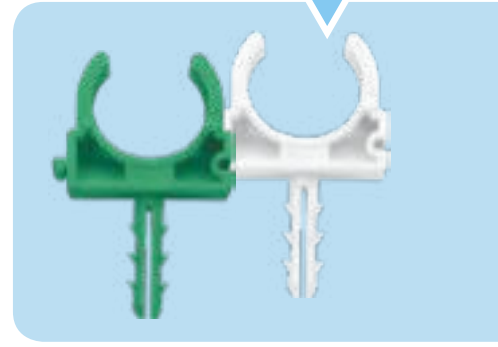

Крепление с фиксатором двойное | حاملة الأنبوب الثنائية

Code	Size (ϕ)	ϕ d1	ϕ d2	E	Packing Unit/pcs
CDK-200000	20	20	8	28	2000
CDK-250000	25	25	8	28	1200
CDK-320000	32	32	8	28	750

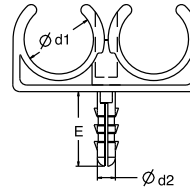

DOUBLE FIXING CLAMP

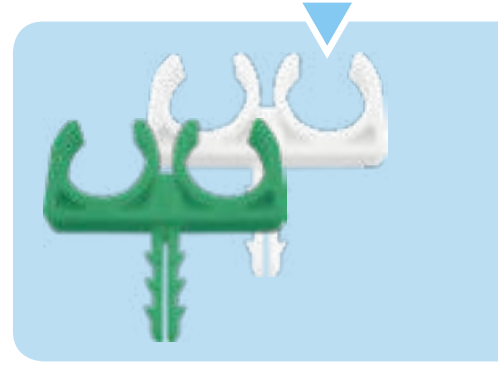

Опора двойная с креплением | اداة تثبيت الانابيب بالارض

Code	Size (ϕ)	ϕ d1	ϕ d2	E	Packing Unit/pcs
DCK-250000	25	25	8	28	1000

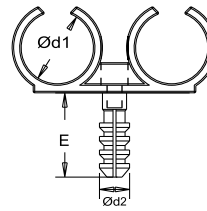

DOUBLE CROSHET WITH PLUG

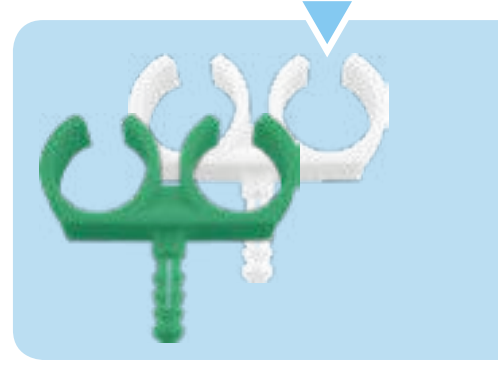

Опора двойная | اداة تثبيت الانابيب بالارض

Code	Size (ϕ)	ϕ d1	Packing Unit/pcs
CTK-250000	25	22	2500

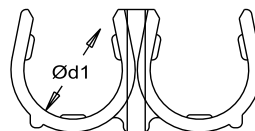

DOUBLE CROSHET

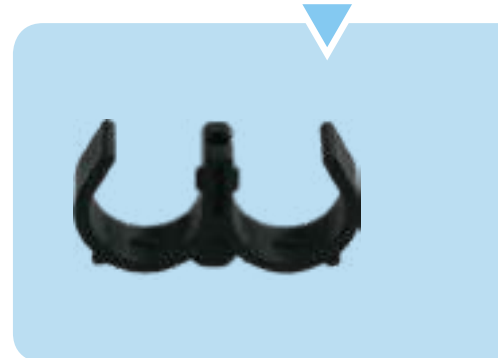

Available Colours

DOUBLE PIPE FIXTURE

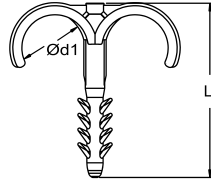

Крепление для фиксации труб двойное | مثبتة حابيس الأنبوب

Code	Size (ϕ)	ϕ d1	L	Packing Unit/pcs
YTC-250000	25	22	58	4000

SINGLE PIPE FIXTURE

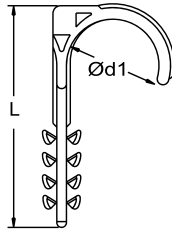

Крепление для фиксации труб | اداة تثبيت الأنبوب

Code	Size (ϕ)	ϕ d1	L	Packing Unit/pcs
TYT-250000	25	22	56	800

CORNER CONDUIT

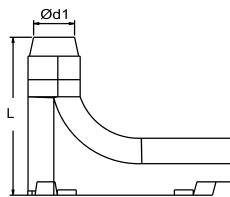

Угловая подводка | تقويم الجانب

Code	ϕ d1	L	Packing Unit/pcs
KDZ-180000	18	90	200

PIPE HOLDER WITH CLIPS

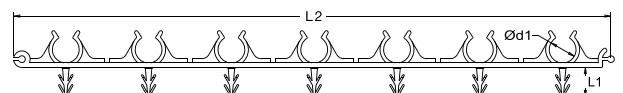

Крепление | حابيس الأنبوب

Code	ϕ d1	L1	L2	Packing Unit/pcs
KPL-160000	16	17.5	360	350



Крепитель для труб | ماسكة الأنبوب

Code	Size (ϕ)	E	Packing Unit/pcs
BRT-200000	20	37	8000

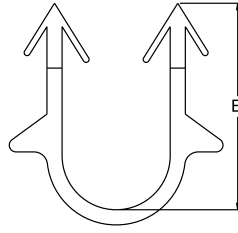

BRACKET

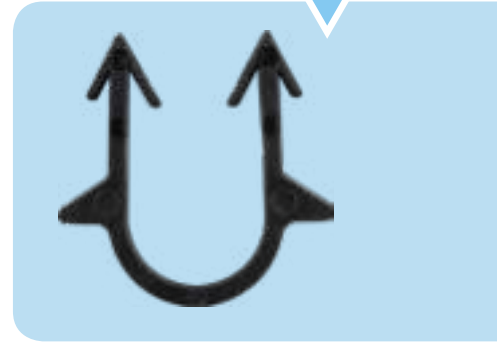

Крепитель для профиля | قوس حامل

Code	Size (ϕ)	L	E	Packing Unit/pcs
LMT-240000	24	24	24	8000

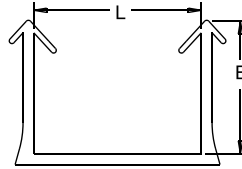

HOLDER BRACKET

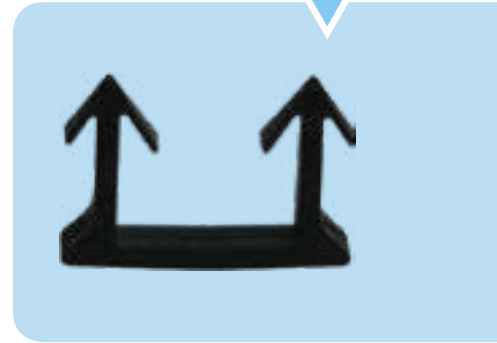

Заглушка для труб PEX | كأس لتوصيل الأنابيب

Code	Packing Unit/pcs
BTP-161700	5000

END CUP FOR PEX PIPES



sky
series



formül[®]

6

TOOLS

Металлические хомуты с гайкой для труб | مسكة من الكروم بدون انبوب

Code	Size (ø)	ROD	Ø d1	Packing Unit/pcs
STK-000038	3/8"	8 Rod	3/8	275
STK-000012	1/2"	8 Rod	1/2"	200
STK-000034	3/4"	8 Rod	3/4	200
STK-000100	1"	8 Rod	1	150
STK-000114	1 1/4"	8 Rod	1 1/4	125
STK-000112	1 1/2"	8 Rod	1 1/2"	100
STK-000200	2"	8 Rod	2	75
STK-000212	2 1/2"	10 Rod	2 1/2	60
STK-000300	3"	10 Rod	3	60
STK-000312	3 1/2"	10 Rod	3 1/2	60
STK-000400	4"	10 Rod	4	60
STK-000412	4 1/2"	10 Rod	4 1/2	50
STK-000500	5"	10 Rod	5	40
STK-000512	5 1/2"	10 Rod	5 1/2	50
STK-000600	6"	10 Rod	6	50
STK-000800	8"	12 Rod	8	35
STK-001000	10"	12 Rod	10	10

Металлический штепсель | مسمار معدني

Code	Size (ø)	Packing Unit/pcs
CKD-080000	M8	100
CKD-100000	M10	100
CKD-120000	M12	100

Металлический штепсель прямой | نحوية للأنايب بكس

Code	Size (ø)	Packing Unit/pcs
GMD-060000	M6	100
GMD-080000	M8	100
GMD-100000	M10	100
GMD-120000	M12	100

Металлический штепсель Особый | مسمار معدني

Code	Size (ø)	Packing Unit/pcs
CMD-080000	M8	100
CMD-100000	M10	100
CMD-120000	M12	100

METAL CLAMP + TRIPHON**METAL PLUG****METAL PLUG STRAIGHT****SPECIAL METAL PLUG**

PIPE CUTTER



Ножницы для труб GM 0012-42 | مقص الأنبوب

Code	
DBM-001242	GM 0012-42
DBM-002863	GM 0028-63
DBM-002775	GM 0027-75

WELDING KIT



Комплект сварочного аппарата | مكينة لحم الأنابيب

Code	
KMS-000500	GM 0005
KMS-0008A0	GM 0008
KMS-002100	GM 0021 without welding tools and cutter

WELDING KIT mini



Комплект сварочного аппарата | مكينة لحم الأنابيب

Code	
FR-00KG-MKM-000900	GM MINI 0009

SINGLE WELDING MACHINE



Сварочный аппарат | مكينة لحم الأنابيب

Code	
LKM-0009A0	GM 00009A
SKM-000900	GM 0009
PKM-0009B0	GM 0009B

Насос для измерения давления 0-60 атм | مضخة تجربة الضغط

Code	
TSP-003000	GM 0030

TEST PRESSURE PUMP



Насадка на сварочный инструмент | اداة مكينة اللحام

Code	Size (σ)
BKP-200000	20
BKP-250000	25
BKP-320000	32
BKP-400000	40
BKP-500000	50
BKP-630000	63
BKP-750000	75
BKP-900000	90
BKP-110000	110
BKP-125000	125

WELDING TOOL



Насадка для вварного седла | اداة مكينة اللحام

Code	Size (σ)
BKP-632000	63/20
BKP-632500	63/25
BKP-633200	63/32
BKP-752000	75/20
BKP-752500	75/25
BKP-753200	75/32
BKP-902000	90/20
BKP-902500	90/25
BKP-903200	90/32
BKP-110200	110/20
BKP-110250	110/25
BKP-110320	110/32

WELDING TOOL FOR SADDLES

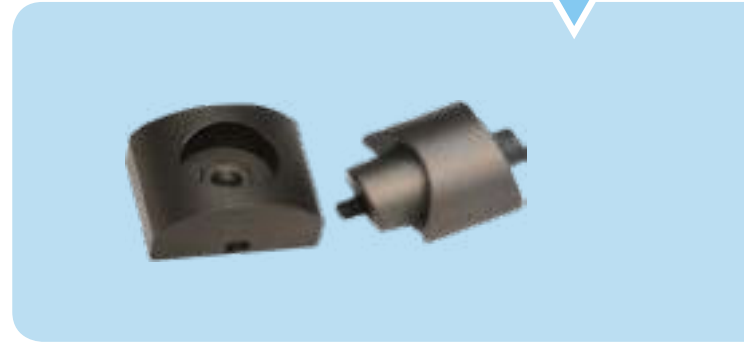

Ремонтный комплект | مسبار لتلحيم الثقب

Code	
BKA-000000	

REPAIR TOOL

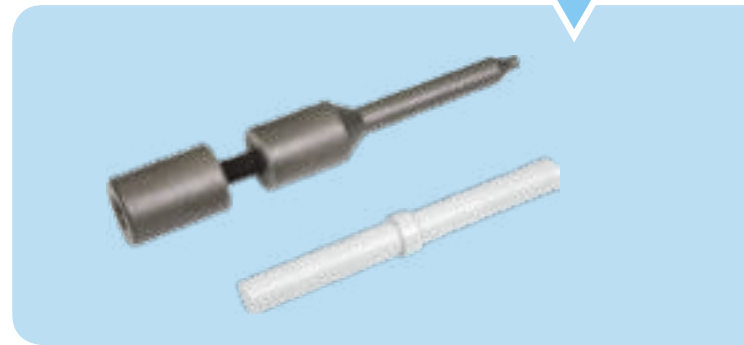

FIXING

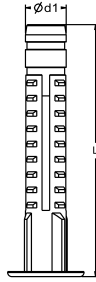
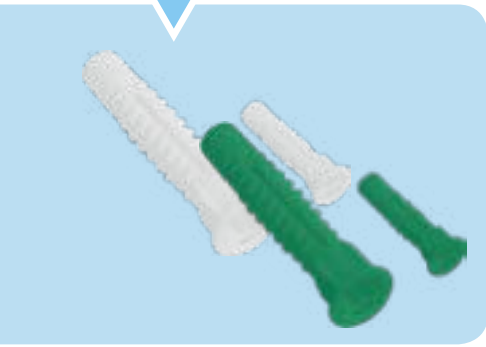

Пластиковый дюбель | سدة من البلاستيك

Code	Size (\varnothing)	\varnothing d1	L	Packing Unit/pcs
PDB-060000	M6	6	30	30000
PDB-080000	M8	8	45	10000
PDB-100000	M10	10	60	5000

FIXING

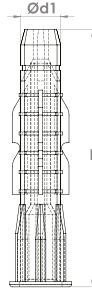

Пластиковый дюбель | سدة من البلاستيك

Code	Size (\varnothing)	\varnothing d1	L	Packing Unit/pcs
RDB-080000	M8	8	51	10000
RDB-100000	M10	10	61	6000

TRANSITION FOR GAS PIPES



Переходник для газовой трубы (межстенна) | الانتقال لأنابيب الغاز

Code	Size (\varnothing)	Packing Unit/pcs
BGS-000034	25 x 3/4"	175
BGS-000100	32 x 1"	140

TRANSITION FOR PEX PIPES



Переходник для трубы Pex | نجوية لأنابيب بكس

Code	Color	Packing Unit/pcs
BGP-160000	White	120
BGP-160000	Chrome	120



formül[®]

**PVC PIPES
& FITTINGS**

7

PIPES (TYPE 1) s= 3 to 3.9 mm



PIPES (TYPE 2) s= 1.8 to 3.2 mm



Code	Size	Packing Unit/pcs
TP1-050015	50/150	100
TP1-050025	50/250	80
TP1-050050	50/500	30
TP1-050100	50/1000	10
TP1-050200	50/2000	10
TP1-050300	50/3000	10
TP1-050600	50/6000	1
TP1-075015	75/150	50
TP1-075025	75/250	30
TP1-075050	75/500	15
TP1-075100	75/1000	5
TP1-075200	75/2000	5
TP1-075300	75/3000	5
TP1-075600	75/6000	1
TP1-110015	110/150	25
TP1-110025	110/250	20
TP1-110050	110/500	8
TP1-110100	110/1000	5
TP1-110200	110/2000	5
TP1-110300	110/3000	5
TP1-110600	110/6000	1
TP1-125015	125/150	18
TP1-125025	125/250	12
TP1-125050	125/500	10
TP1-125100	125/1000	5
TP1-125200	125/2000	5
TP1-125300	125/3000	3
TP1-125600	125/6000	1
TP1-160015	160/150	15
TP1-160025	160/250	15
TP1-160050	160/500	6
TP1-160100	160/1000	4
TP1-160200	160/2000	3
TP1-160300	160/3000	1
TP1-160600	160/6000	1
TP1-200015	200/150	5
TP1-200025	200/250	5
TP1-200050	200/500	2
TP1-200100	200/1000	1
TP1-200200	200/2000	1
TP1-200300	200/3000	1
TP1-200600	200/6000	1

Code	Size	Packing Unit/pcs
TP2-050050	50/500	30
TP2-050100	50/1000	10
TP2-050200	50/2000	10
TP2-050300	50/3000	10
TP2-050600	50/6000	1
TP2-075050	75/500	15
TP2-075100	75/1000	5
TP2-075200	75/2000	5
TP2-075300	75/3000	5
TP2-075600	75/6000	1
TP2-110050	110/500	8
TP2-110100	110/1000	5
TP2-110200	110/2000	5
TP2-110300	110/3000	5
TP2-110600	110/6000	1
TP2-125050	125/500	10
TP2-125100	125/1000	5
TP2-125200	125/2000	5
TP2-125300	125/3000	5
TP2-125600	125/6000	1
TP2-160050	160/500	6
TP2-160100	160/1000	4
TP2-160200	160/2000	3
TP2-160300	160/3000	3
TP2-160600	160/6000	1
TP2-200050	200/500	2
TP2-200100	200/1000	1
TP2-200200	200/2000	1
TP2-200300	200/3000	1
TP2-200600	200/6000	1

Code	Size	Packing Unit/pcs
DRS-050045	50	200
DRS-075045	75	100
DRS-110045	110	35
DRS-125045	125	20
DRS-160045	160	12
DRS-200045	200	6

Code	Size	Packing Unit/pcs
DRS-050087	50	150
DRS-075087	75	75
DRS-110087	110	25
DRS-125087	125	20
DRS-160087	160	8
DRS-200087	200	5

Code	Size	Packing Unit/pcs
TEC-050050	50x50	100
TEC-075050	75x50	50
TEC-075075	75x75	40
TEC-110050	110x50	30
TEC-110075	110x75	25
TEC-110110	110x110	20
TEC-125125	125x125	10
TEC-160110	160x110	10
TEC-160160	160x160	8
TEC-200110	200x110	5
TEC-200160	200x160	4
TEC-200200	200x200	6

Code	Size	Packing Unit/pcs
TKC-050050	50x50	90
TKC-075050	75x50	50
TKC-075075	75x75	30
TKC-110050	110x50	25
TKC-110075	110x75	20
TKC-110110	110x110	15
TKC-125110	125x110	10
TKC-125125	125x125	10
TKC-160110	160x110	5
TKC-160125	160x125	5
TKC-160160	160x160	4
TKC-200200	200x200	6

ELBOW 45°



ELBOW 87°



SINGLE BRANCH 87°



SINGLE BRANCH 45°



DOUBLE BRANCH 45°



Code	Size	Packing Unit/pcs
YCC-055050	50x50	60
YCC-075050	75x50	40
YCC-075075	75x75	25
YCC-110050	110x50	25
YCC-110075	110x75	15
YCC-110110	110x110	10
YCC-125125	125x125	10

CROSS



Code	Size	Packing Unit/pcs
TCC-050000	50x50	75
TCC-075050	75x50	30
TCC-075075	75x75	25
TCC-110050	110x50	25
TCC-110075	110x75	20
TCC-110110	110x110	10

SOCKET



Code	Size	Packing Unit/pcs
KMN-050000	50	150
KMN-075000	75	75
KMN-110000	110	35
KMN-125000	125	25
KMN-160000	160	12
KMN-200000	200	8

REDUCTION



Code	Size	Packing Unit/pcs
RDK-075050	75x50	150
RDK-110050	110x50	70
RDK-110075	110x75	50
RDK-125075	125x75	50
RDK-125110	125x110	30
RDK-160075	160x75	25
RDK-160160	160x110	25
RDK-200110	200x110	21
RDK-200160	200x160	18

Code	Size	Packing Unit/pcs
TMT-110000	110	15
TMT-125000	125	10
TMT-160000	160	8
TMT-200000	200	6

CLEANING TEE



Code	Size	Packing Unit/pcs
KPM-050000	50	750
KPM-075000	75	300
KPM-110000	110	130
KPM-125000	125	100
KPM-160000	160	75

PLUG



Code	Size	Packing Unit/pcs
SFN-070087	75x87°	8
SFN-070045	75x45°	8
SFN-110087	110x87°	10
SFN-110045	110x45°	10

SIPHON



Code	Size	Packing Unit/pcs
EKK-110000	110	150

KADA



WASTE WATER CLAMP

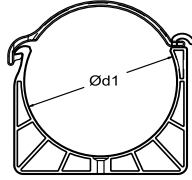

Крепление для сливных труб | مربوط بلاستيك

Code	Size (ϕ)	ϕ d1	Packing Unit/pcs
ATK-050000	50	50	250
ATK-063000	63	63	200
ATK-075000	75	75	100
ATK-110000	110	110	130
ATK-125000	125	125	100
ATK-160000	160	160	75
ATK-200000	200	200	35

RAIN GUTTER CLAMP

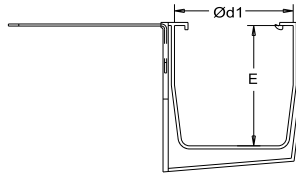

Крепление для четырехугольных желоб | مربوط بلاستيك

Code	Size (ϕ)	ϕ d1	E	Packing Unit/pcs
PDK-150000	150	150	150	75

RAIN GUTTER CLAMP WITH METALIC SUPPORT

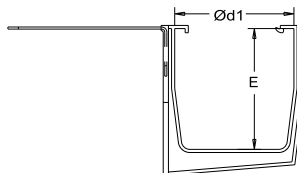
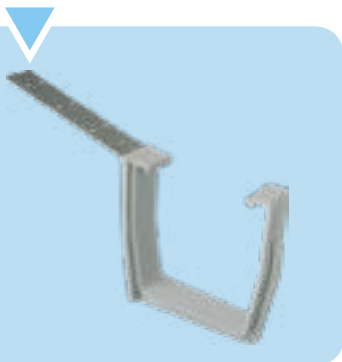

Крепление для четырехугольных желоб с металлическим держателем | مربوط بلاستيك

Code	Size (ϕ)	ϕ d1	E	Packing Unit/pcs
MDK-150000	150	150	150	75

Крепление для шестиугольных желоб | مربوط بلاستيك

Code	Size (ϕ)	ϕ d1	E	Packing Unit/pcs
PDK-125000	125	125	75	100

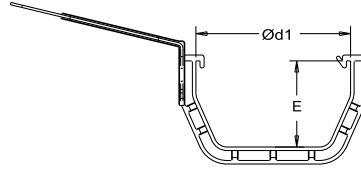

SPECIAL RAIN GUTTER CLAMP

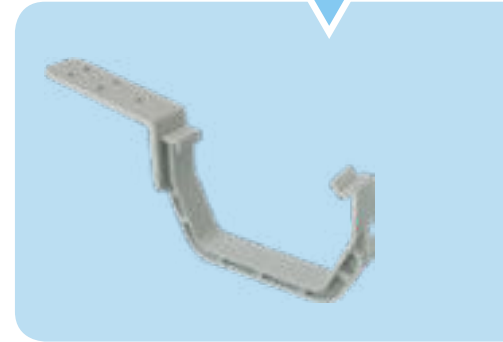

SPECIAL RAIN GUTTER CLAMP WITH METALIC SUPPORT

Крепление для шестиугольных желоб с металлическим держателем | مربوط بلاستيك

Code	Size (ϕ)	ϕ d1	E	Packing Unit/pcs
MDK-125000	125	125	75	100

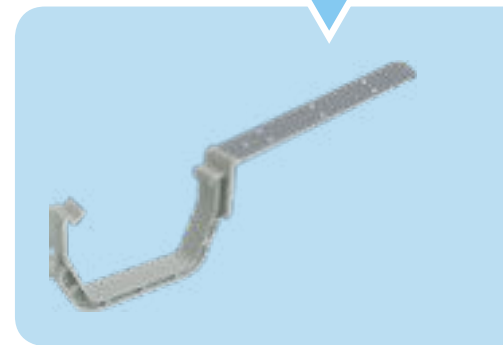
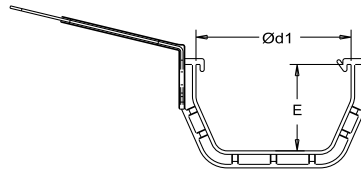

Крепление для квадратных сливных труб | مربوط بلاستيك

Code	Size (ϕ)	ϕ d1	E	Packing Unit/pcs
PIK-100000	100	100	75	100

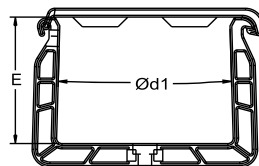

SPECIAL WASTE WATER CLAMP

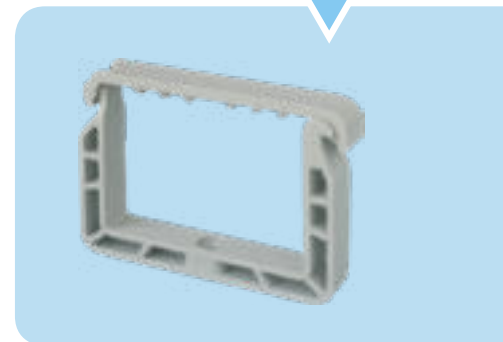

NON RETURN VALVE - locked



Code	Size	Packing Unit/pcs
KLC-110000	110	12
KLC-125000	125	12
KLC-160000	160	8
KLC-200000	200	4

VENTILATION GRILLS



Вентиляционная крышка | مشاوي التهوية

Code	Packing Unit/pcs
DMZ-000000	100

JOINT GASKET



Code	Size	Packing Unit/pcs
ADC-050000	50	750

80 countries in 5 continents



World-wide Service

formül®

PP-R, PVC PIPES AND FITTINGS

export@formul.com.tr



HEAD OFFICE

Cumhuriyet Mah. Gürpınar Yolu
Cad. Kaya Milenyum İş Merkezi
K:8 N:5A/144
Büyüçekmece / İSTANBUL

T: +90 212 876 12 60
F: +90 212 876 12 59



PLASTIC FACTORY

Veliköy OSB Sanayi Bulvarı
N:19/4A
Çerkezköy / TEKİRDAĞ

T: +90 282 746 15 60
F: +90 282 746 15 59



PVC FACTORY

Veliköy OSB Sanayi Bulvarı
2. Cad. N:19/1
Çerkezköy / TEKİRDAĞ

T: +90 282 746 15 54
F: +90 282 746 15 59



METAL FACTORY

Gazi Osmanpaşa OSB
1. Cad. N:135
Çerkezköy / TEKİRDAĞ

T: +90 282 758 25 06
F: +90 282 758 25 05

formul.com.tr

07.2022