

since 1982



2020



ikizler



Certificates



WARNING

1. Product pictures in the catalogue cannot be used or published without our knowledge and written consent.
2. All electrical values given are rated values. Luminous flux and connected electrical load are subject to an initial tolerance of +/- 10%. Tolerance of colour temperature: +/-150 K. Unless stated otherwise, the values apply to an ambient temperature of 25°C.
3. İkizler Lighting has the right to make changes or cancellations on the products without notification. Updated information on the products can be received from our web site.
4. Products are separated as 'indoor' and 'outdoor' lighting in the catalogue. Indoor lighting products must not be used for outdoor areas.



About Us

Ikizler Lighting, with over 40 years of experience in Lighting industry, carries its operations and investments to the 21th century in regards to human and nature oriented lighting.

Production facilities, located in Sakarya 3rd Industrial Zone and built on 15.000 square meters, covers automated manufacturing lines & Lighting laboratory and R&D center, where design and certification studies are being held.

The company has ISO 9001, ISO 14001 (Environmental Management Systems) and ISO 45001 (Occupational Health & Safety) certificates to support company's utmost focus on satisfaction for both customers and employees.

Ikizler Lighting follows the Total Quality Management System to ensure an unconditional customer satisfaction and supports this by TUV Germany approved ENEC and T.S.E. (Turkish Standards Institute) certifications for the products.

Ikizler builds its sustainable growth strategy on design and improvement of energy efficient LED products, and gives maximum concentration on R&D activities. Ideal light is attained with the optimal energy consumption by using optical design and simulation programs during design process.

R&D, production and sales forces are teamed by experienced engineers to provide full technical support to customers.

Our Vision

Provide sustainable growth and brand awareness in local & international lighting industry.

Our Mission

- Increasing our share in global market;
- Becoming a Solution partner for our customers;
- Developing innovative, environment-friendly and energy efficient products;
- Investing in technology and design;
- Building the systems to satisfy customer requirements and demands at maximum level;
- Supplying continuous training, improvement and motivation for employees;
- Integrating digitalization to all our units and products.



Awards



2019
Superior
Design Award



2010
Good Design Award



2014
Good Design Award



2018
Good Design Award













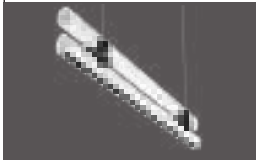
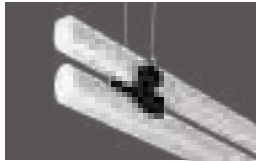
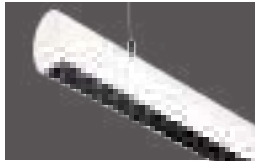



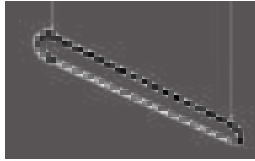
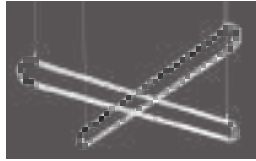



2019
Good Design Award

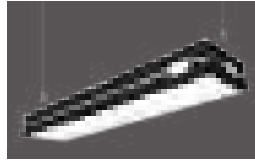

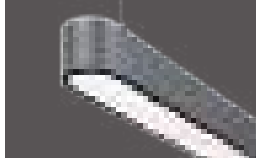
reddot award 2015
winner lighting design

1

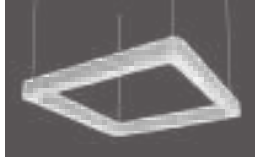
PENDANT LIGHTING

				
NEST DUO-R P.14	NEST DUO-D P.17	NEST-R P.18	NEST-D P.19	NORD-D P.20
				
NORD-R P.23	ZEN P.24	U-LINE 01131 P.26	U-LINE 01135 P.29	U-LINE 01132 P.30
				
U-LINE 01136 P.32	DUET-P P.35	GRUS GAMMA P.37	ECLIPSE P.39	ORION SAIF P.41
				
STYLE-P 1230 P.42	STYLE-P 1209 P.43	DARKLINE 1200 P.44	CORVUS INN P.45	ANGEL 1200 P.46
				
ANGEL 0900 P.49	ANGEL 0600 P.50	TURN SQUARE 0900 P.52	TURN SQUARE 1200 P.53	

2

LINEAR LIGHTING

				
LIGHTLINE-045 P.56	LIGHTLINE-058 P.58	LIGHTLINE MC-058 P.61	LIGHTLINE-150 P.62	WATERLINE P.64



SPEEDLINE P.65

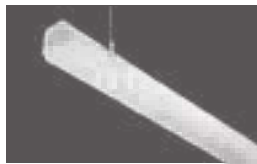

RUNNING P.67



RUNNING P.68



RUNNING P.70

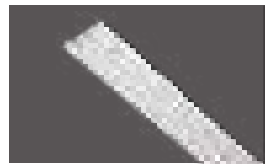

RUNNING P.70

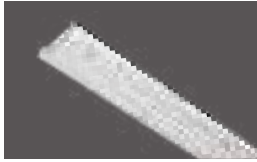

RUNNING P.70



LIGHTLINE-075 P.73

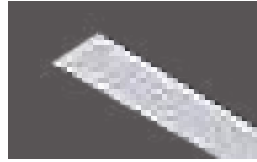

LIGHTLINE-046 P.74

DOWNLIGHT LIGHTING

3



LUNA-023 P.79



LUNA-019 P.80



LUNA-IP65 P.82



SNOW-023 P.84



SNOW-017 P.85

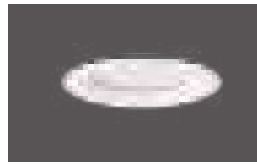

SNOW-014 P.85

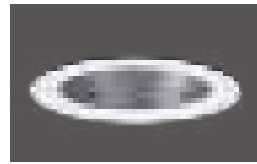

SLOT-023 P.86



SLOT-019 P.87



VIVID P.88



CANVAS P.91



LUNA-T P.92



CANVAS-T P.93

SPOT LIGHTING

4

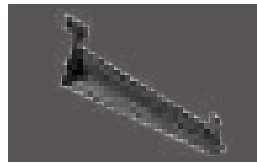

YUWI P.96



DUET-R P.98



DUET-T P.99



MODUS DC P.101

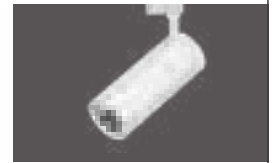

MODUS P.102



MODUSBOX P.103



SPARROW P.104







DRAGON P.106



ADELLA K1 P.108

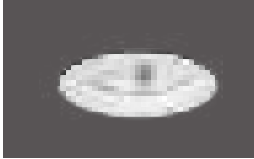



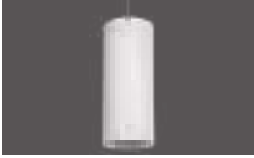







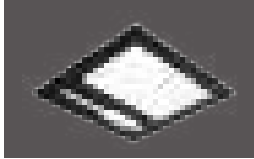

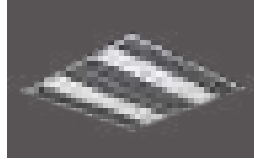









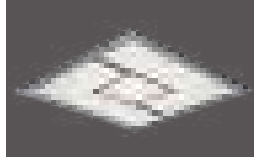

ADELLA K2 P.109

				
STAR P.110	STAR MINI P.111	DARKPIT-140 P.112	DARKPIT-118 P.113	DARKPIT-090 P.113
				
SILVERPIT-140 P.114	SILVERPIT-118 P.115	SILVERPIT-090 P.115	FOSTERI P.117	CELL P.118
				
DROP P.120	MINO P.122	HOLLOW P.125	STYLED P.126	STYLED-W P.127
				
JEWEL P.128	JEWELMINI P.129	TETRAD 085 P.130	TETRAD 060 P.132	TETRAD 140 P.135
				
MODUS-T P.136	MODUS-S P.137			

5

RECESSED LIGHTING

				
DUET SHORT P.140	DUET LONG P.142	NOON MAXI P.144	NOON MIDI P.146	NOON MINI P.147
				
CORVUS-G 1200 P.148	CORVUS-G 900 P.149	CORVUS-G 600 P.149	CORVUS-G 500 P.151	CORVUS-G 380 P.151

				
ROLLING P.152	ORION P.153	DARKLINE P.154	SILVERLINE P.155	GLARE-G P.156
				
PART-G P.157	DOME-G P.158	SECTION P.160	COMFORT-G P.161	BALIO-G P.162
				
TIE-G P.163	BRAID P.164	SPIDER P.165	ASTRAL P.166	CROSS P.167
				
RING P.168	TWIG P.169	TETR'S-G P.170	ROUND P.171	FULLMOON P.172
				
STELA P.173	LEAF P.174	GRUS SIGMA P.175	FLAT-G 600 P.176	FLAT-G 1230 P.179
				
FLAT-G 300 P.180	FLAT-C 600 P.182	FLAT-C 300 P.183		

SURFACE LIGHTING

6

				
CORVUS-T 1200 P.186	CORVUS-T 900 P.187	CORVUS-T 600 P.187	CORVUS-T 500 P.189	CORVUS-T 380 P.189

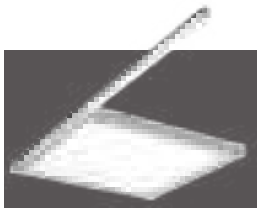

GUIDE P.190

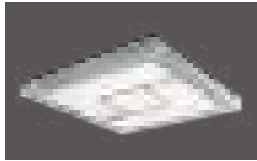

TETR's-T P.192



DOME-T P.193



TIE-T P.194



PART-T P.195



STYLE-600 P.196



STYLE-1200 P.197



FLAT-T 600 P.198

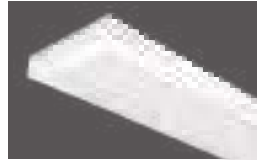

FLAT-T 1230 P.199



FLAT-T 300 P.200



GLARE-T P.201



ORION ALNITAK P.202

7

WALL LUMINAIRES



MIRROLINE P.206



FINE P.207



WIDE P.209

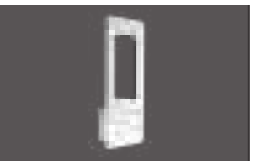

CALM P.210



REED P.211

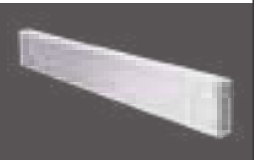

COMET P.212



MARK P.213



SINUS P.216



SPACE P.218

8 COVE LIGHTING

9

STERILE ROOM LIGHTING



SHIELD-G 600 P.222



SHIELD-G 1200 P.224



EVEN-G 600 P.226



EVEN-G 1200 P.227



WINK-G P.228



SHIELD-T P.229

INDUSTRIAL LIGHTING

10



SUMBA P.233



MINSU P.234

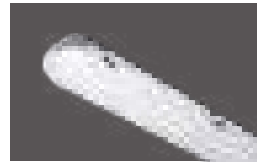

PROOF P.235



DOVE P.236

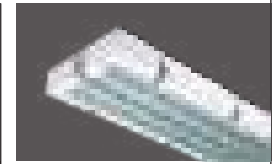

RISING P.238

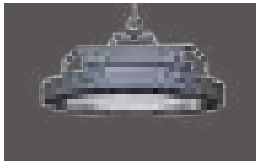

GETTO P.240

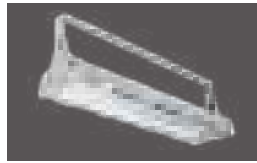

POTENT P.243

OUTDOOR LIGHTING

11

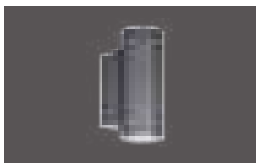

BEAM-D P.246

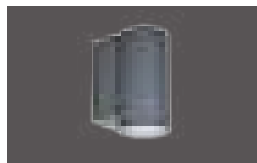

BEAM-S P.247

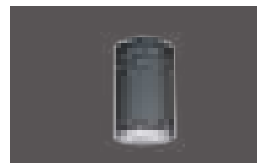

BEAM-T P.248



PLATE P.249



EDGE P.250



SUNNY P.252



SUNNY-R P.253



ANEMON P.254

EMERGENCY EXIT SIGN LUMINAIRE

12



ESCAPE P.258



RUN P.259



FREE P.260



SHEER P.262



VITAL P.263



APLED P.264



CICALA P.265



1 | PENDANT LIGHTING

NEST DUO-R

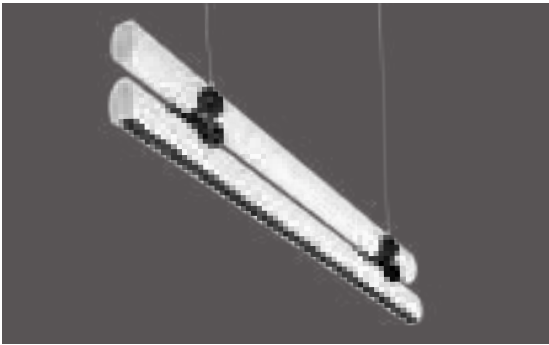

Housing	Extruded aluminum profile with electrostatic coating
Reflector	Direct: Highly efficient, aluminum coated, vacuumed PC reflector and deglaring (UGR < 17) Indirect: Opal diffuser
Light Source	High efficacy Mid Power LED with lifetime L80B50 > 50,000h
Driver	Constant current output, Pf>0.90
Supply Voltage	220-240V/50-60Hz
Ambient Temperature	-20C°/+40C°
Options	Dali

Color Options

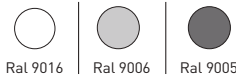

Joint Piece

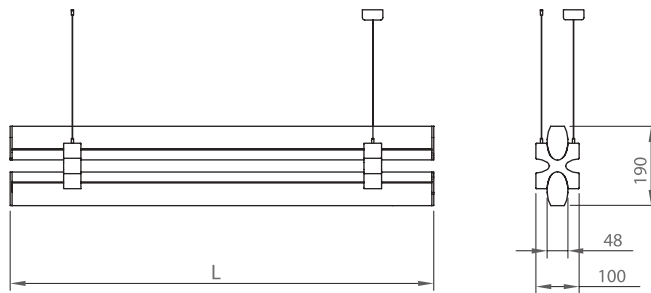
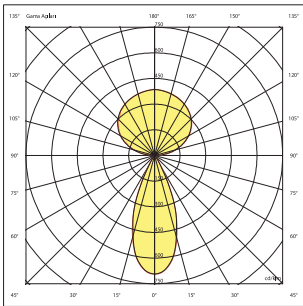
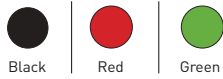

Order Code	W	Lm	CCT	Beam Angle	CRI	L (mm)	Kg
01190.11.30.053	51	5390	3000	36°	Ra>80	1130	3,2
01190.11.30.068	60	6860	3000	36°	Ra>80	1440	4,1
01190.11.40.057	51	5700	4000	36°	Ra>80	1130	3,2
01190.11.40.072	60	7270	4000	36°	Ra>80	1440	4,1



Nest LED profile design is inspired by the joint piece that creates a bold color texture while connecting two profiles. Nest took its name after this joint piece that plays a role as a nest to two profiles.



2018
Good Design Award

Design: Omlet İstanbul Design Office



NEST DUO-D

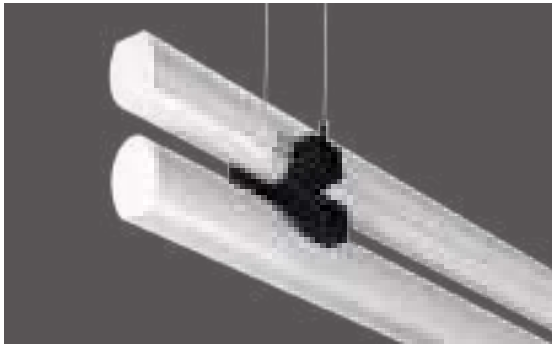

Housing	Extruded aluminum profile with electrostatic coating
Diffuser	Highly transmissive opal diffuser
Light Source	High efficacy Mid Power LED with lifetime L80B50 > 50,000h
Driver	Constant current output, Pf>0.90
Supply Voltage	220-240V/50-60Hz
Ambient Temperature	-20C°/+40C°
Options	Dali

Color Options



Joint Piece

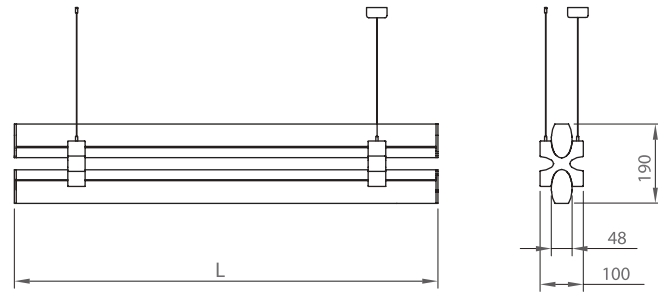
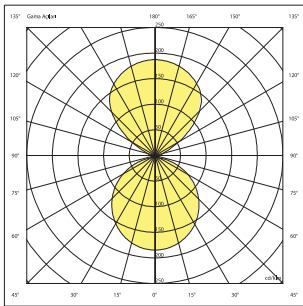
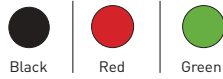

Order Code	W	Lm	CCT	CRI	L (mm)	Kg
01190.11.30.049	51	4900	3000	Ra>80	1145	3,2
01190.11.30.057	60	5700	3000	Ra>80	1425	4,1
01190.11.40.052	51	5200	4000	Ra>80	1145	3,2
01190.11.40.060	60	6050	4000	Ra>80	1425	4,1

NEST-R

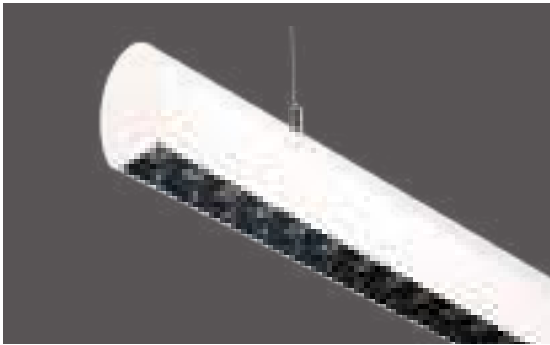

Housing	Extruded aluminum profile with electrostatic coating
Reflector	Highly efficient, aluminum coated, vacuumed PC reflector and deglaring (UGR < 17)
Light Source	High efficacy Mid Power LED with lifetime L80B50 > 50,000h
Driver	Constant current output, Pf>0.90
Supply Voltage	220-240V/50-60Hz
Ambient Temperature	-20C°/+40C°
Options	Dali

Color Options

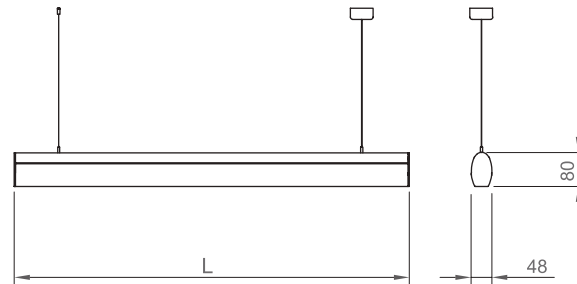
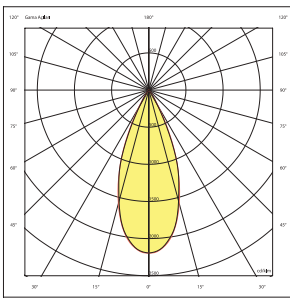
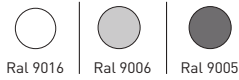

Order Code	W	Lm	CCT	Beam Angle	CRI	L (mm)	Kg
01187.47.30.034	32	3500	3000	36°	Ra>80	1125	1,8
01187.47.30.044	41	4500	3000	36°	Ra>80	1440	2,3
01187.47.40.037	32	3700	4000	36°	Ra>80	1125	1,8
01187.47.40.047	41	4750	4000	36°	Ra>80	1440	2,3

Design: Omlet İstanbul Design Office

For more updated information, please visit our website. www.ikizlerlighting.com

NEST-D



Housing	Extruded aluminum profile with electrostatic coating
Diffuser	Highly transmissive opal diffuser
Light Source	High efficacy Mid Power LED with lifetime L80B50 > 50,000h
Driver	Constant current output, Pf>0.90
Supply Voltage	220-240V/50-60Hz
Ambient Temperature	-20C°/+40C°
Options	Dali

Color Options

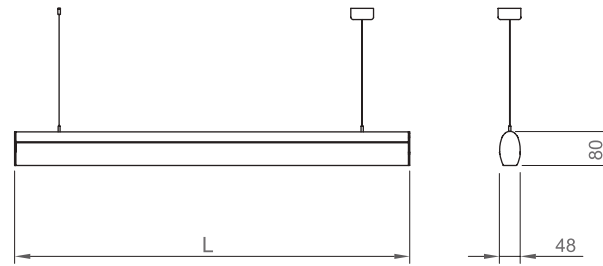
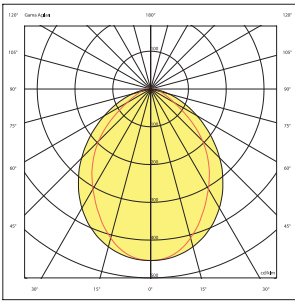
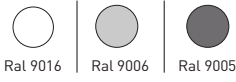

Order Code	W	Lm	CCT	CRI	L (mm)	Kg
01180.47.30.030	35	3000	3000	Ra>80	1145	1,8
01180.47.30.037	41	3760	3000	Ra>80	1425	2,3
01180.47.40.031	35	3200	4000	Ra>80	1145	1,8
01180.47.40.039	41	4000	4000	Ra>80	1425	2,3

Design: Omlet İstanbul Design Office

NORD-D



Housing	Extruded aluminum profile with electrostatic coating
Diffuser	Highly transmissive opal diffuser
Light Source	High efficacy Mid Power LED with lifetime L80B50 > 50,000h
Driver	Constant current output, Pf>0.90
Supply Voltage	220-240V/50-60Hz
Ambient Temperature	-20C°/+40C°
Options	Dali 3 hour emergency lighting kit

Color Options

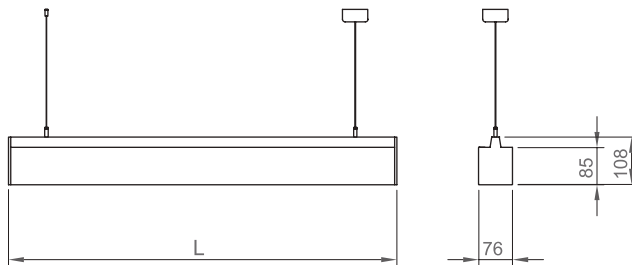
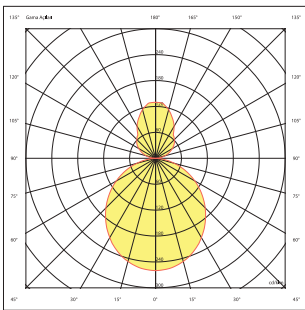
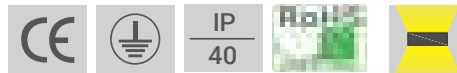
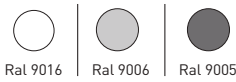

Order Code	W	Lm	CCT	CRI	L (mm)	Kg
01181.71.30.036	38	3650	3000	Ra>80	1145	3,2
01181.71.30.045	48	4520	3000	Ra>80	1425	4,0
01181.71.40.038	38	3830	4000	Ra>80	1145	3,2
01181.71.40.047	48	4780	4000	Ra>80	1425	4,0

For more updated information, please visit our website. www.ikizlerlighting.com

NORD-R

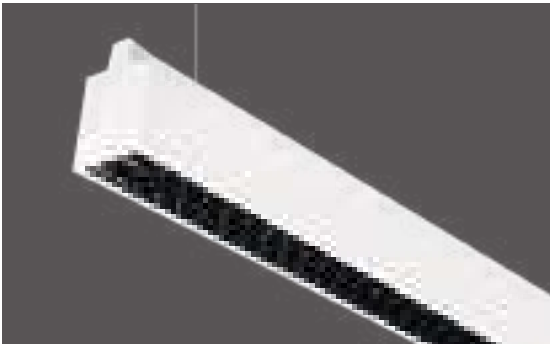

Housing	Extruded aluminum profile with electrostatic coating
Reflector	Direct: Highly efficient, aluminum coated, vacuumed PC reflector and deglaring (UGR<17) Indirect: Opal diffuser
Light Source	High efficacy Mid Power LED with lifetime L80B50 > 50,000h
Driver	Constant current output, Pf>0.90
Supply Voltage	220-240V/50-60Hz
Ambient Temperature	-20C°/+40C°
Options	Dali 3 hour emergency lighting kit

Color Options

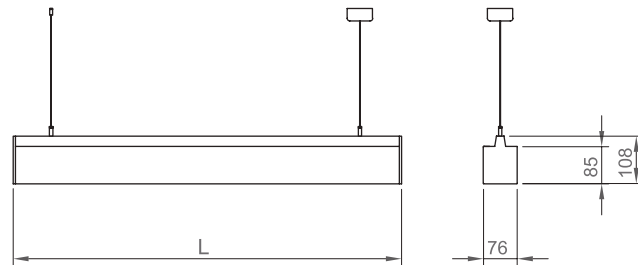
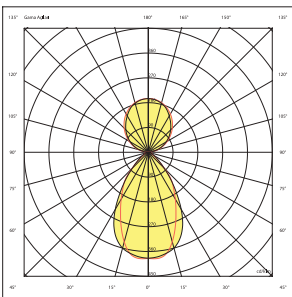
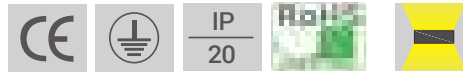
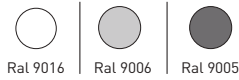

Order Code	W	Lm	CCT	Beam Angle	CRI	L (mm)	Kg
01181.71.30.060	56	6040	3000	36°	Ra>80	1125	3,2
01181.71.30.081	72	8170	3000	36°	Ra>80	1440	4,0
01181.71.40.064	56	6400	4000	36°	Ra>80	1125	3,2
01181.71.40.086	72	8600	4000	36°	Ra>80	1440	4,0

ZEN



Housing	Extruded aluminum profile with electrostatic coating
Diffuser	Direct: Acrylic optic lens, Indirect: Opal diffuser
Light Source	High efficacy Mid Power LED with lifetime L80B50 > 50,000h
Driver	Constant current output, Pf>0.90
Supply Voltage	220-240V/50-60Hz
Ambient Temperature	-20C°/+40C°
Options	Dali 3 hour emergency lighting kit

Color Options

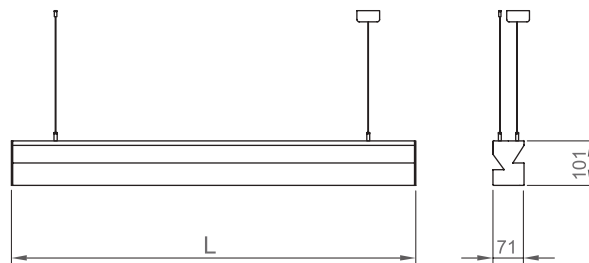
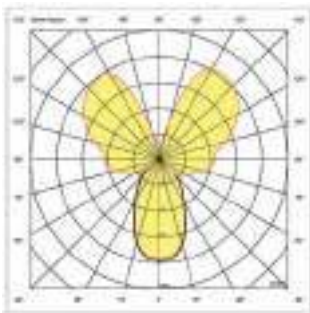
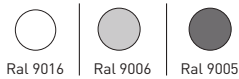

Order Code	W	Lm	CCT	CRI	L (mm)	Kg
01184.71.30.075	61	7570	3000	Ra>80	1260	4,2
01184.71.30.091	75	9160	3000	Ra>80	1510	5,1
01184.71.40.080	61	8020	4000	Ra>80	1260	4,2
01184.71.40.097	75	9700	4000	Ra>80	1510	5,1



Zen, designed with a minimalistic approach, brings out excitement from its Z form seen from the sides. This asymmetric profile design lets the light in different angles and creates an elegant & naive visual asymmetry.

U-LINE 01131

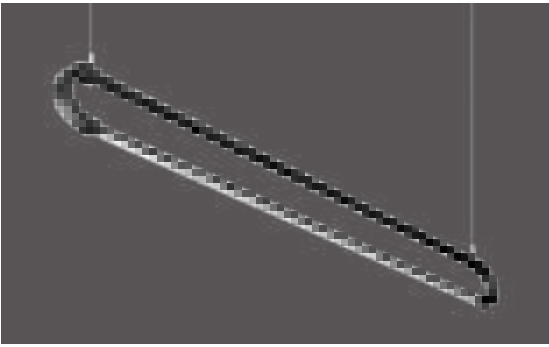

Housing	Aluminum profile
Diffuser	Highly transmissive opal diffuser
Light Source	High efficacy Mid Power LED with lifetime L80B50 > 50,000h
Driver	Constant current output, Pf>0.90
Supply Voltage	220-240V/50-60Hz
Ambient Temperature	-20C°/+40C°
Options	Dali

Color Options

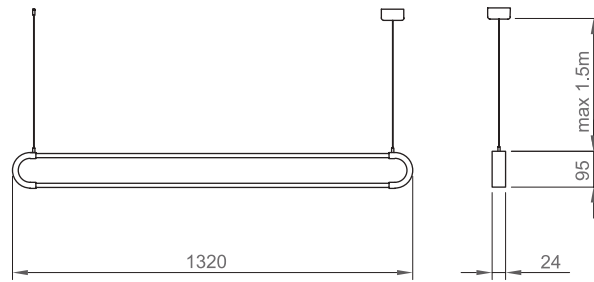
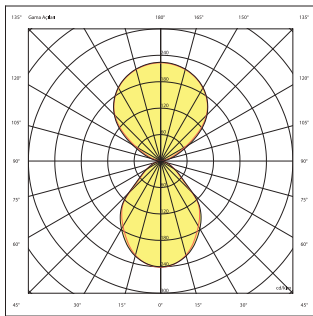
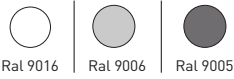

Order Code	W	Lm	CCT	CRI	Kg
01131.13.30.035	36	3500	3000	Ra>80	1,4
01131.13.40.036	36	3600	4000	Ra>80	1,4



U-Line is produced from recyclable extruded aluminium profile and attracts attention with its slim structure. It takes advantage from LED that is highly energy efficient and has a long economic lifetime. U-Line can be applied to offices, meeting rooms, malls and many other areas. U-Line provides distinct visual designs when combined with different joint brackets.

U-LINE has received Good Design Award in Designturkey 2014 and Worldwide prestigious '2015 Red Dot Design Award'.

Design: Omlet İstanbul Design Office



2014
Good Design Award



reddot award 2015
winner lighting design

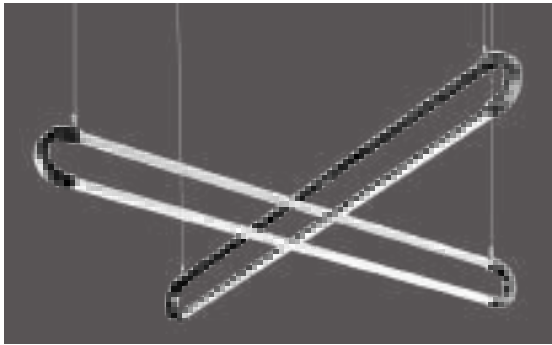

Color Options

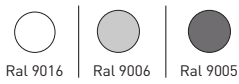

Housing	Aluminum profile
Diffuser	Highly transmissive opal diffuser
Light Source	High efficacy Mid Power LED with lifetime L80B50 > 50,000h
Driver	Constant current output, Pf>0.90
Supply Voltage	220-240V/50-60Hz
Ambient Temperature	-20C°/+40C°
Options	Dali

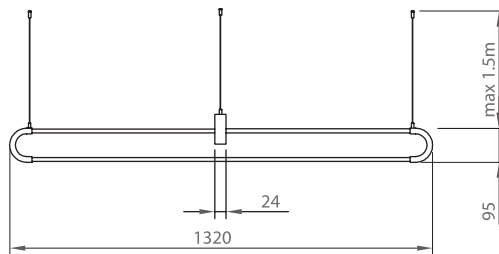
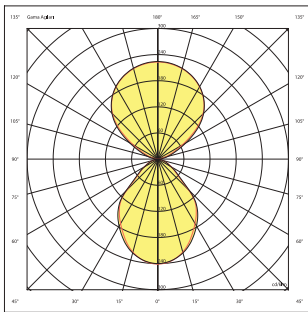

Order Code	W	Lm	CCT	CRI	Kg
01135.13.30.070	72	7000	3000	Ra>80	2,8
01135.13.40.072	72	7200	4000	Ra>80	2,8

U-LINE 01132

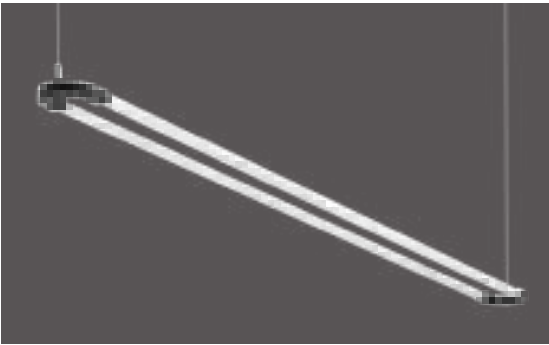

Housing	Aluminum profile
Diffuser	Highly transmissive opal diffuser
Light Source	High efficacy Mid Power LED with lifetime L80B50 > 50,000h
Driver	Constant current output, Pf>0.90
Supply Voltage	220-240V/50-60Hz
Ambient Temperature	-20C°/+40C°
Options	Dali

Color Options

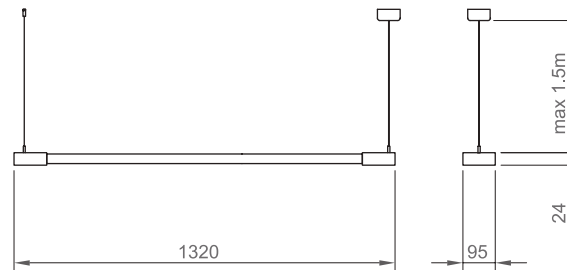
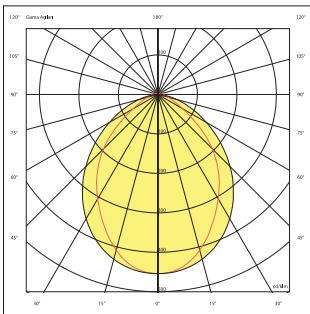
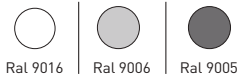

Order Code	W	Lm	CCT	CRI	Kg
01132.13.30.035	36	3500	3000	Ra>80	1,4
01132.13.40.036	36	3600	4000	Ra>80	1,4

U-LINE 01136

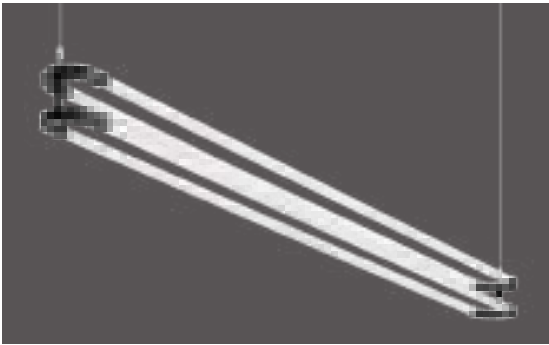

Housing	Aluminum profile
Diffuser	Highly transmissive opal diffuser
Light Source	High efficacy Mid Power LED with lifetime L80B50 > 50,000h
Driver	Constant current output, Pf>0.90
Supply Voltage	220-240V/50-60Hz
Ambient Temperature	-20C°/+40C°
Options	Dali

Color Options

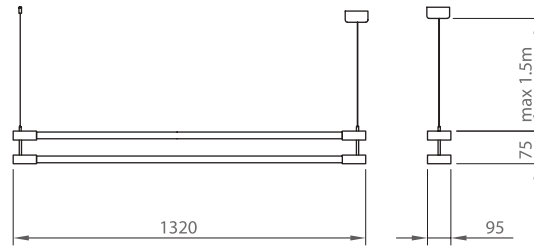
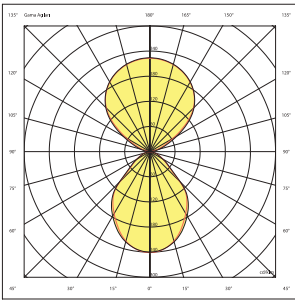
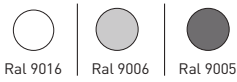

Order Code	W	Lm	CCT	CRI	Kg
01136.13.30.070	72	7000	3000	Ra>80	2,8
01136.13.40.072	72	7200	4000	Ra>80	2,8



DUET-P

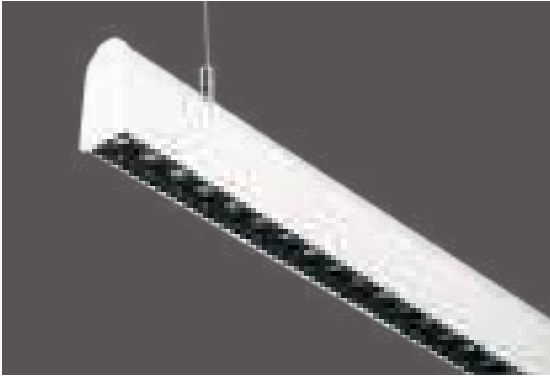

Housing	Extruded aluminum profile with electrostatic coating
Reflector	Highly efficient, aluminum coated, vacuumed PC reflector and deglaring (UGR<17)
Light Source	High efficacy Mid Power LED with lifetime L80B50 > 50,000h
Driver	Constant current output, Pf>0.90
Supply Voltage	220-240V/50-60Hz
Ambient Temperature	-20C°/+40C°
Options	Dali 3 hour emergency lighting kit

Color Options

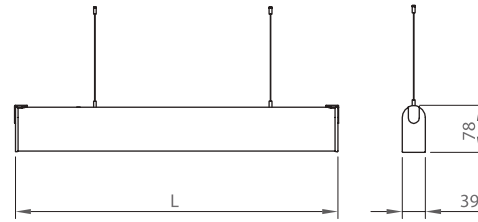
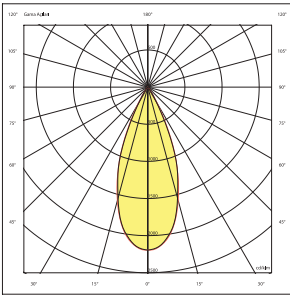
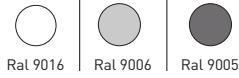

Order Code	W	Lm	CCT	Açı	CRI	L (mm)	Kg
01181.37.30.024	22	2400	3000	36°	Ra>80	1225	3,6
01181.37.30.036	34	3660	3000	36°	Ra>80	1495	4,4
01181.37.40.025	22	2540	4000	36°	Ra>80	1225	3,6
01181.37.40.038	34	3880	4000	36°	Ra>80	1495	4,4

GRUS GAMMA

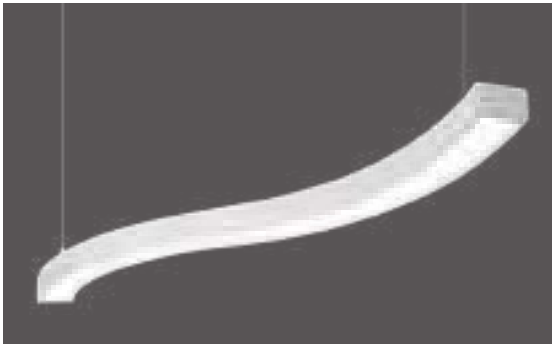

Housing	Extruded aluminum profile with electrostatic coating
Diffuser	Highly transmissive opal diffuser
Light Source	High efficacy Mid Power LED with lifetime L80B50 > 50,000h
Driver	Constant current output, Pf>0.90
Supply Voltage	220-240V/50-60Hz
Ambient Temperature	-20C°/+40C°
Options	Dali 3 hour emergency lighting kit

Color Options



Ral 9016



Ral 9006



Ral 9005

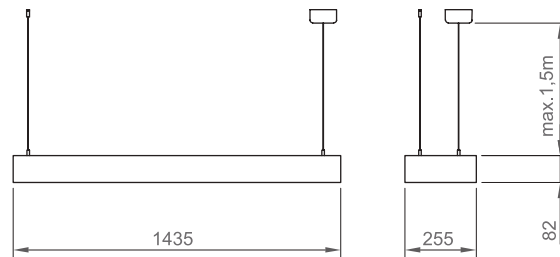
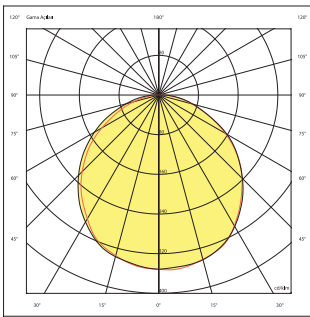

Order Code	W	Lm	CCT	CRI	Kg
06114.14.30.049	54	4900	3000	Ra>80	3,0
06114.14.40.051	54	5100	4000	Ra>80	3,0

ECLIPSE



Color Options



Ral 9005

Housing	Electrostatic coated steel sheet
Diffuser	Highly transmissive opal diffuser
Light Source	High efficacy Mid Power LED with lifetime L80B50 > 50,000h
Driver	Constant current output, Pf>0.90
Supply Voltage	220-240V/50-60Hz
Ambient Temperature	-20C°/+40C°
Options	Dali

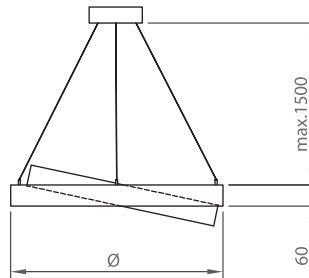
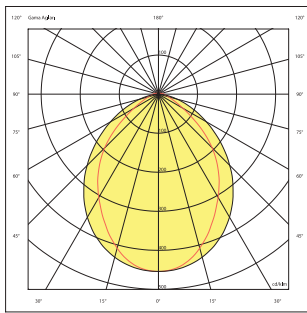

Order Code	W	Lm	CCT	CRI	L (mm)	Kg
03170.60.30.056	55	5600	3000	Ra>80	Ø600	8,0
03170.90.30.091	90	9000	3000	Ra>80	Ø900	12
03170.60.40.058	55	5800	4000	Ra>80	Ø600	8,0
03170.90.40.096	90	9600	4000	Ra>80	Ø900	12

ORION SAIF

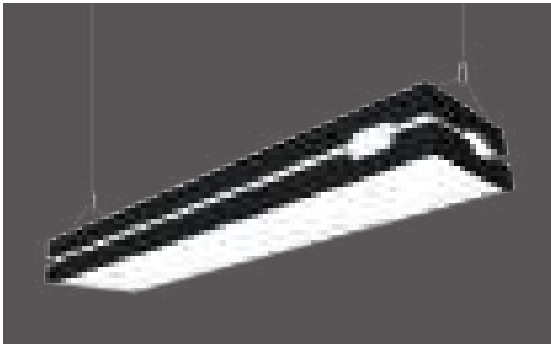

Housing	Extruded aluminum profile with electrostatic coating
Diffuser	Highly transmissive opal diffuser
Light Source	MacAdam Step-3 high efficacy Mid Power LED with lifetime L70 > 50,000h
Driver	Constant current output, Pf>0.90
Supply Voltage	220-240V/50-60Hz
Ambient Temperature	-20C°/+40C°
Options	Dali 3 hour emergency lighting kit

Color Options



Ral 9016



Ral 9006



Ral 9005

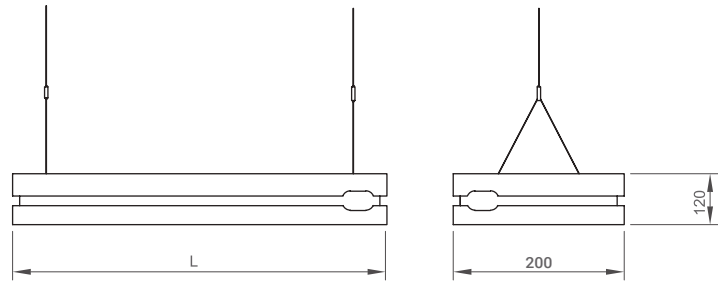
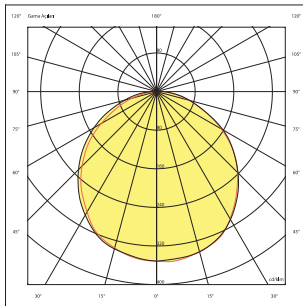

Order Code	W	Lm	CCT	CRI	L (mm)	Kg
01117.21.30.039	46	4000	3000	Ra>80	1180	4,8
01117.21.40.041	46	4200	4000	Ra>80	1180	4,8

STYLE-P 1230



Housing	Extruded aluminum profile with electrostatic coating
Diffuser	Highly transmissive opal diffuser
Light Source	High efficacy Mid Power LED with lifetime L80B50 > 50,000h
Driver	Constant current output, Pf>0.90
Supply Voltage	220-240V/50-60Hz
Ambient Temperature	-20C°/+40C°
Options	Dali 3 hour emergency lighting kit

Color Options

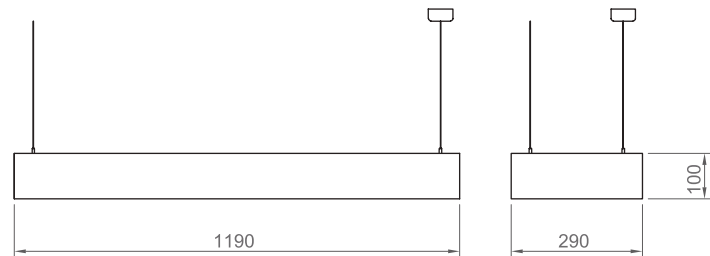
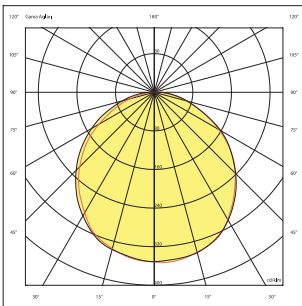
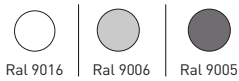

Order Code	W	Lm	CCT	CRI	Kg
03137.31.30.032	31	3200	3000	Ra>80	4,2
03137.31.40.033	31	3300	4000	Ra>80	4,2

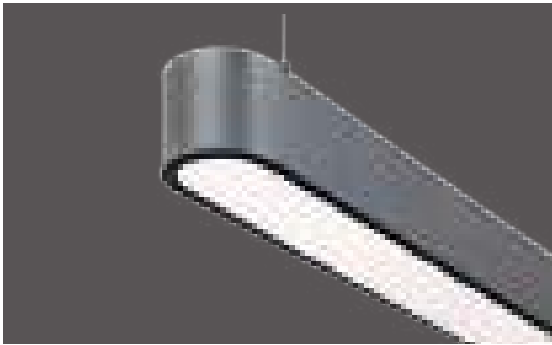

Housing	Extruded aluminum profile with electrostatic coating
Diffuser	Highly transmissive opal diffuser
Light Source	High efficacy Mid Power LED with lifetime L80B50 > 50,000h
Driver	Constant current output, Pf>0.90
Supply Voltage	220-240V/50-60Hz
Ambient Temperature	-20C°/+40C°
Options	Dali 3 hour emergency lighting kit

Color Options

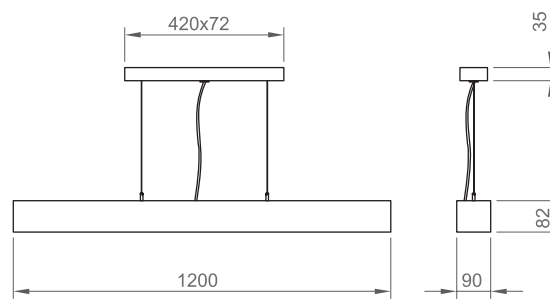
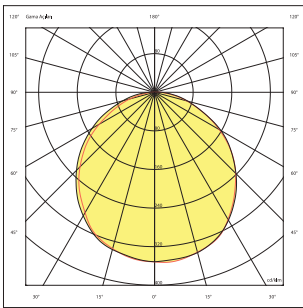

Order Code	W	Lm	CCT	CRI	Kg
03137.91.30.034	41	3470	3000	Ra>80	4,2
03137.91.40.036	41	3670	4000	Ra>80	4,2

DARKLINE 1200

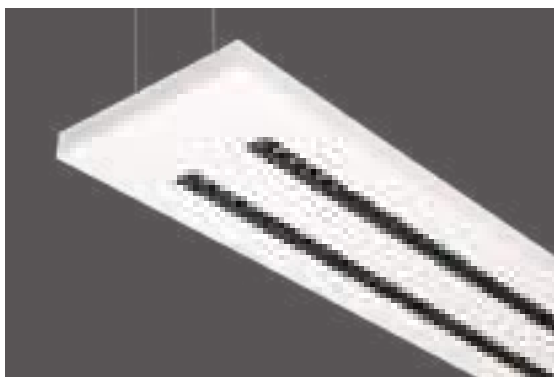

Housing	Extruded aluminum profile with electrostatic coating
Reflector	Highly efficient, aluminum coated, vacuumed PC reflector and deglaring (UGR<17)
Light Source	High efficacy Mid Power LED with lifetime L80B50 > 50,000h
Driver	Constant current output, Pf>0.90
Supply Voltage	220-240V/50-60Hz
Ambient Temperature	-20C°/+40C°
Options	Dali 3 hour emergency lighting kit

Color Options

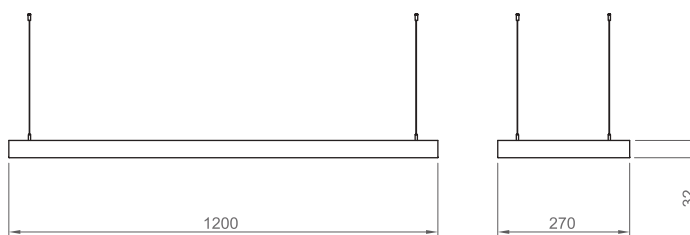
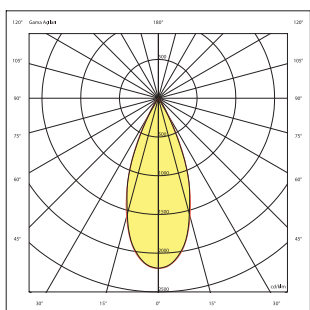

Order Code	W	Lm	Beam Angle	CCT	CRI	Kg
02173.31.30.034	31	3420	36°	3000	Ra>80	5,3
02173.31.40.036	31	3630	36°	4000	Ra>80	5,3

CORVUS INN



Housing	Extruded aluminum profile with electrostatic coating
Diffuser	Highly transmissive opal diffuser
Light Source	High efficacy Mid Power LED with lifetime L80B50 > 50,000h
Driver	Constant current output, Pf>0.90
Supply Voltage	220-240V/50-60Hz
Ambient Temperature	-20C°/+40C°
Options	Dali

Color Options

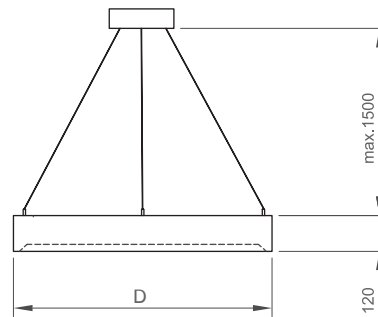
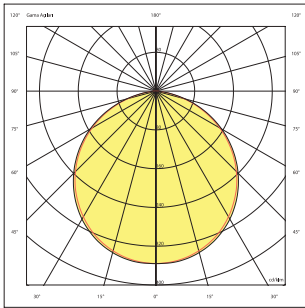
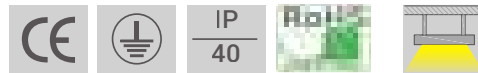
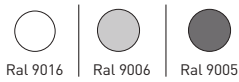

Order Code	W	Lm	CCT	CRI	D	Kg
03170.60.30.018	19	1850	3000	Ra>80	Ø400	2,7
03170.60.30.030	38	3670	4000	Ra>80	Ø600	4,0
03170.60.40.019	19	1950	3000	Ra>80	Ø400	2,7
03170.60.40.040	38	3900	4000	Ra>80	Ø600	4,0

ANGEL 1200

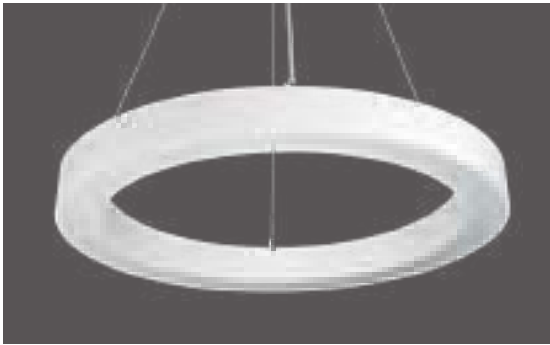

Color Options

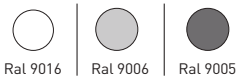

Housing	Extruded aluminum profile with electrostatic coating
Diffuser	Highly transmissive opal diffuser
Light Source	High efficacy Mid Power LED with lifetime L80B50 > 50,000h
Driver	Constant current output, Pf>0.90
Supply Voltage	220-240V/50-60Hz
Ambient Temperature	-20C°/+40C°
Options	Dali

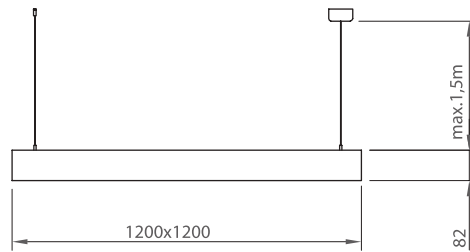
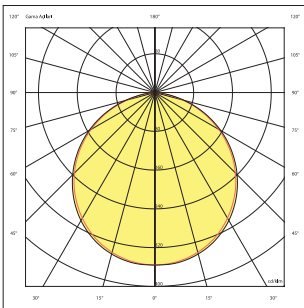

Order Code	W	Lm	CCT	CRI	Kg
01140.12.30.057	60	5760	3000	Ra>80	6,0
01140.12.30.102	120	10270	3000	Ra>80	6,0
01140.12.40.061	60	6100	4000	Ra>80	6,0
01140.12.40.108	120	10870	4000	Ra>80	6,0



Housing	Extruded aluminum profile with electrostatic coating
Diffuser	Highly transmissive opal diffuser
Light Source	High efficacy Mid Power LED with lifetime L80B50 > 50,000h
Driver	Constant current output, Pf>0.90
Supply Voltage	220-240V/50-60Hz
Ambient Temperature	-20C°/+40C°
Options	Dali

Color Options

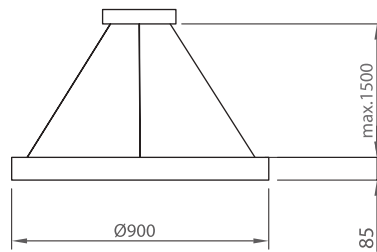
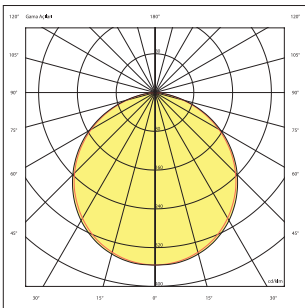
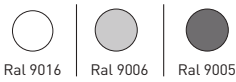

Order Code	W	Lm	CCT	CRI	Kg
01140.90.30.055	60	5560	3000	Ra>80	4,5
01140.90.30.077	90	7700	3000	Ra>80	4,5
01140.90.40.058	60	5900	4000	Ra>80	4,5
01140.90.40.081	90	8150	4000	Ra>80	4,5

ANGEL 0600



Housing	Extruded aluminum profile with electrostatic coating
Diffuser	Highly transmissive opal diffuser
Light Source	High efficacy Mid Power LED with lifetime L80B50 > 50,000h
Driver	Constant current output, Pf>0.90
Supply Voltage	220-240V/50-60Hz
Ambient Temperature	-20C°/+40C°
Options	Dali

Color Options

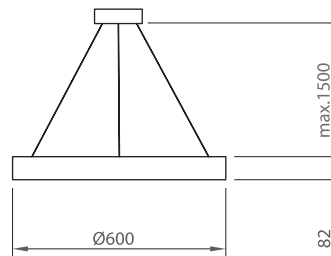
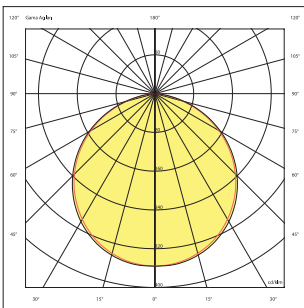
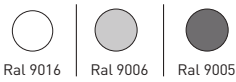

Order Code	W	Lm	CCT	CRI	Kg
01140.60.30.037	40	3700	3000	Ra>80	3,0
01140.60.30.051	60	5130	3000	Ra>80	3,0
01140.60.40.039	40	3980	4000	Ra>80	3,0
01140.60.40.054	60	5430	4000	Ra>80	3,0

1200 TURN SQUARE

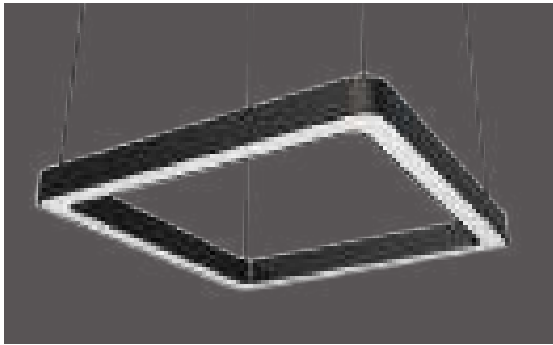

Housing	Extruded aluminum profile with electrostatic coating
Diffuser	Highly transmissive opal diffuser
Light Source	High efficacy Mid Power LED with lifetime L80B50 > 50,000h
Driver	Constant current output, Pf>0.90
Supply Voltage	220-240V/50-60Hz
Ambient Temperature	-20C°/+40C°
Options	Dali

Color Options

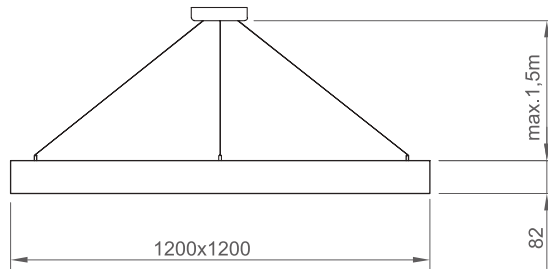
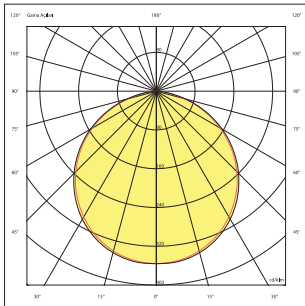

Order Code	W	Lm	CCT	CRI	Kg
03138.11.30.098	107	9900	3000	Ra>80	7,0
03138.11.40.104	107	10470	4000	Ra>80	7,0



2 | LINEAR LIGHTING

LIGHTLINE-045



Housing	Extruded aluminum profile with electrostatic coating
Optics	Highly transmissive opal PC diffuser
Light Source	High efficacy Mid Power LED with lifetime L80B50 > 50,000h
Driver	Constant current output, Pf>0.90
Supply Voltage	220-240V/50-60Hz
Ambient Temperature	-20C°/+40C°
Options	Dali 3 hour emergency lighting kit

Color Options

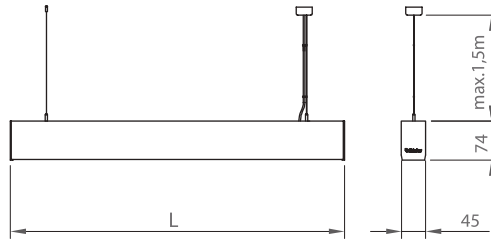
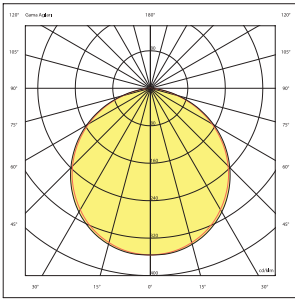
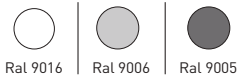

Order Code	W	Lm	K	CRI	L (mm)	Kg
01180.47.30.015	15	1420	3000	Ra>80	575	1,8
01180.47.30.023	22	2140	3000	Ra>80	855	2,0
01180.47.30.030	28	2810	3000	Ra>80	1135	2,4
01180.47.30.039	35	3570	3000	Ra>80	1415	2,8
01180.47.40.016	15	1500	4000	Ra>80	575	1,8
01180.47.40.024	22	2260	4000	Ra>80	855	2,0
01180.47.40.032	28	3020	4000	Ra>80	1135	2,4
01180.47.40.040	35	3770	4000	Ra>80	1415	2,8

LIGHTLINE-058



Housing	Extruded aluminum profile with electrostatic coating
Optics	Highly transmissive opal PC diffuser
Light Source	High efficacy Mid Power LED with lifetime L80B50 > 50,000h
Driver	Constant current output, Pf>0.90
Supply Voltage	220-240V/50-60Hz
Ambient Temperature	-20C°/+40C°
Options	Dali 3 hour emergency lighting kit

Color Options

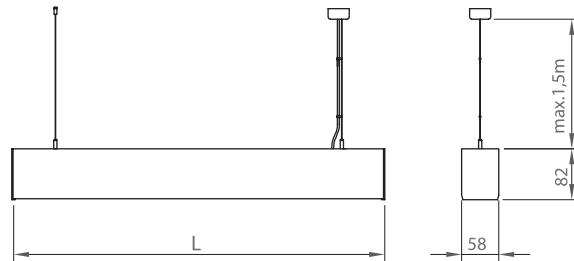
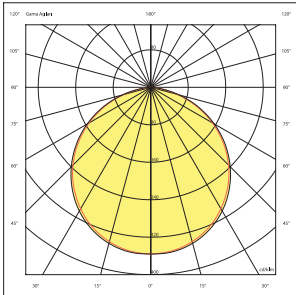
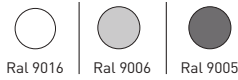

Order Code	W	Lm	K	CRI	L (mm)	Kg
01180.57.30.015	15	1400	3000	Ra>80	575	1,3
01180.57.30.021	21	1910	3000	Ra>80	575	1,3
01180.57.30.023	22	2110	3000	Ra>80	855	2,0
01180.57.30.032	31	2860	3000	Ra>80	855	2,0
01180.57.30.031	29	2815	3000	Ra>80	1135	2,7
01180.57.30.043	42	3810	3000	Ra>80	1135	2,7
01180.57.30.038	36	3520	3000	Ra>80	1415	3,2
01180.57.30.053	52	4770	3000	Ra>80	1415	3,2
01180.57.30.046	43	4220	3000	Ra>80	1695	3,7
01180.57.30.064	62	5720	3000	Ra>80	1695	3,7
<hr/>						
01180.57.40.016	15	1480	4000	Ra>80	575	1,3
01180.57.40.022	21	2020	4000	Ra>80	575	1,3
01180.57.40.024	22	2230	4000	Ra>80	855	2,0
01180.57.40.033	31	3030	4000	Ra>80	855	2,0
01180.57.40.032	29	2970	4000	Ra>80	1135	2,7
01180.57.40.044	42	4040	4000	Ra>80	1135	2,7
01180.57.40.039	36	3710	4000	Ra>80	1415	3,2
01180.57.40.055	52	5060	4000	Ra>80	1415	3,2
01180.57.40.048	43	4460	4000	Ra>80	1695	3,7
01180.57.40.066	62	6050	4000	Ra>80	1695	3,7

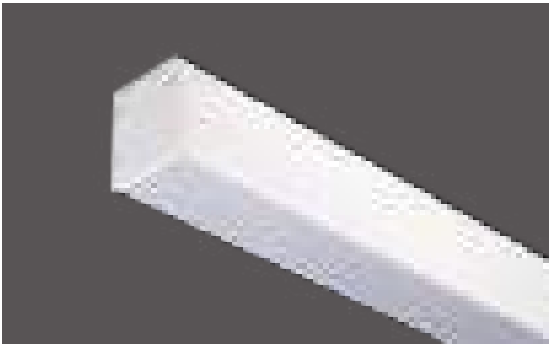

Housing	Extruded aluminum profile with electrostatic coating
Optics	Micro-prismatic diffuser with UGR>19 effect
Light Source	High efficacy Mid Power LED with lifetime L80B50 > 50,000h
Driver	Constant current output, Pf>0.90
Supply Voltage	220-240V/50-60Hz
Ambient Temperature	-20C°/+40C°
Options	Dali 3 hour emergency lighting kit

Color Options

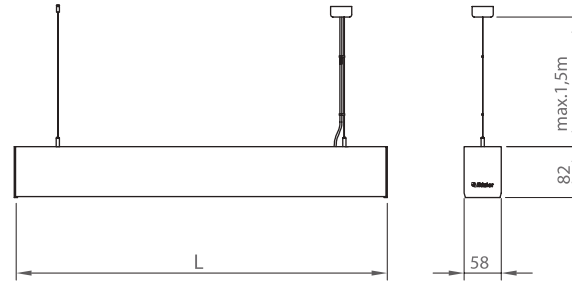
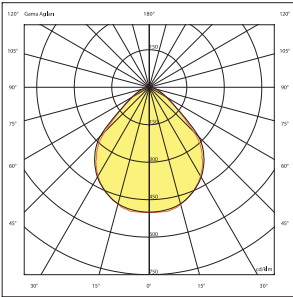
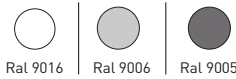

Order Code	W	Lm	K	CRI	L (mm)	Kg
01180.57.30.015	15	1650	3000	Ra>80	575	1,3
01180.57.30.021	21	2310	3000	Ra>80	575	1,3
01180.57.30.023	22	2420	3000	Ra>80	855	2,0
01180.57.30.032	31	3410	3000	Ra>80	855	2,0
01180.57.30.031	29	3190	3000	Ra>80	1135	2,7
01180.57.30.043	42	4620	3000	Ra>80	1135	2,7
01180.57.30.038	36	3960	3000	Ra>80	1415	3,2
01180.57.30.053	52	5720	3000	Ra>80	1415	3,2
01180.57.30.046	44	4840	3000	Ra>80	1695	3,7
01180.57.30.064	62	6820	3000	Ra>80	1695	3,7
<hr/>						
01180.57.40.016	15	1730	4000	Ra>80	575	1,3
01180.57.40.022	21	2420	4000	Ra>80	575	1,3
01180.57.40.024	22	2530	4000	Ra>80	855	2,0
01180.57.40.033	31	3585	4000	Ra>80	855	2,0
01180.57.40.032	29	3355	4000	Ra>80	1135	2,7
01180.57.40.044	42	4840	4000	Ra>80	1135	2,7
01180.57.40.039	36	4150	4000	Ra>80	1415	3,2
01180.57.40.055	52	6000	4000	Ra>80	1415	3,2
01180.57.40.048	44	5060	4000	Ra>80	1695	3,7
01180.57.40.066	62	7150	4000	Ra>80	1695	3,7

LIGHTLINE-150

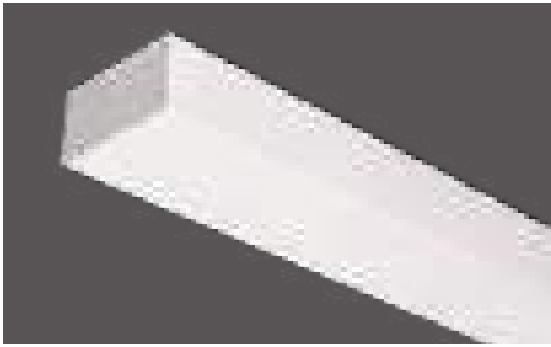

Housing	Extruded aluminum profile with electrostatic coating
Optics	Highly transmissive opal PC diffuser
Light Source	High efficacy Mid Power LED with lifetime L80B50 > 50,000h
Driver	Constant current output, Pf>0.90
Supply Voltage	220-240V/50-60Hz
Ambient Temperature	-20C°/+40C°
Options	Dali 3 hour emergency lighting kit

Color Options

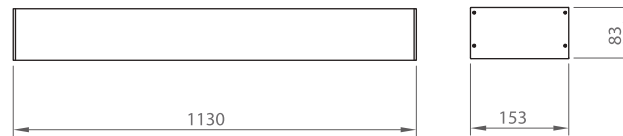
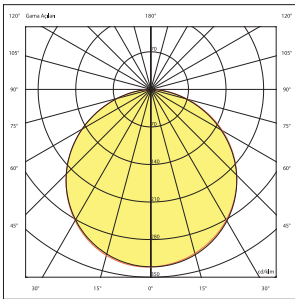
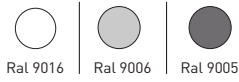

Order Code	W	Lm	K	CRI	Kg
01180.18.30.038	39	3860	3000	Ra>80	3,8
01180.18.30.043	45	4340	3000	Ra>80	3,8
01180.18.40.040	39	4080	3000	Ra>80	3,8
01180.18.40.045	45	4600	4000	Ra>80	3,8

WATERLINE



Housing	Extruded aluminum profile with electrostatic coating
Optics	Highly transmissive opal diffuser
Light Source	High efficacy Mid Power LED with lifetime L80B50 > 50,000h
Driver	Constant current output, Pf>0.90
Supply Voltage	220-240V/50-60Hz
Ambient Temperature	-20C°/+40C°
Options	Dali 3 hour emergency lighting kit

Color Options

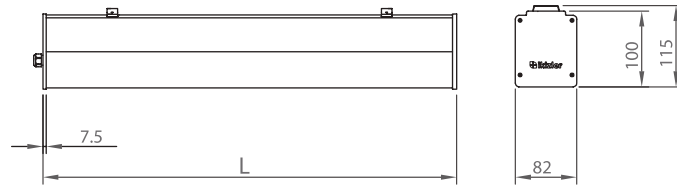
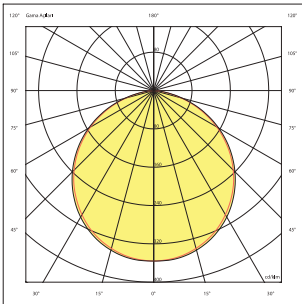
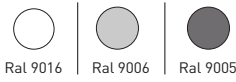

Order Code	W	Lm	K	CRI	L (mm)	Kg
01193.81.30.020	21	1800	3000	Ra>80	590	2,2
01193.81.30.030	31	2700	3000	Ra>80	870	2,5
01193.81.30.041	42	3600	3000	Ra>80	1150	2,9
01193.81.30.052	52	4500	3000	Ra>80	1430	3,3
01193.81.30.063	62	5400	3000	Ra>80	1710	3,8
01193.81.40.022	21	1900	4000	Ra>80	590	2,2
01193.81.40.032	31	2860	4000	Ra>80	870	2,5
01193.81.40.043	42	3800	4000	Ra>80	1150	2,9
01193.81.40.054	52	4770	4000	Ra>80	1430	3,3
01193.81.40.065	62	5720	4000	Ra>80	1710	3,8

SPEEDLINE



Housing	Extruded aluminum profile with electrostatic coating
Optics	Highly transmissive opal PC diffuser
Light Source	High efficacy Mid Power LED with lifetime L80B50 > 50,000h
Driver	Constant current output, Pf>0.90
Supply Voltage	220-240V/50-60Hz
Ambient Temperature	-20C°/+40C°
Options	Dali 3 hour emergency lighting kit

Color Options

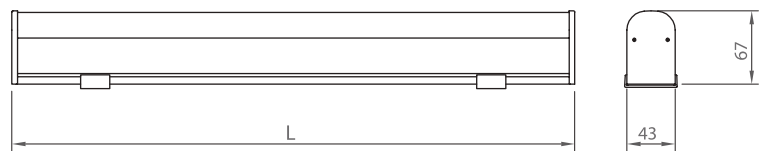
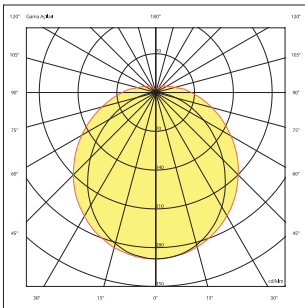
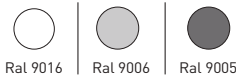

Order Code	W	Lm	K	CRI	L (mm)	Kg
01180.46.30.013	14	1670	3000	Ra>80	580	0,6
01180.46.30.027	27	3220	3000	Ra>80	1130	1,1
01180.46.30.041	41	4880	3000	Ra>80	1680	1,5
01180.46.40.014	14	1800	4000	Ra>80	580	0,6
01180.46.40.030	27	3500	4000	Ra>80	1130	1,1
01180.46.40.044	41	5290	4000	Ra>80	1680	1,5

RUNNING

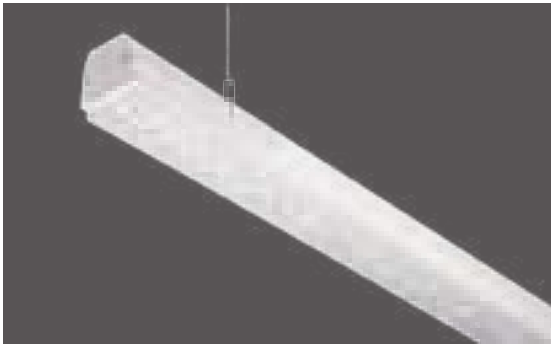

Housing	Extruded aluminum profile with electrostatic coating
Optics	Highly transmissive opal diffuser
Light Source	High efficacy Mid Power LED with lifetime L80B50 > 50,000h
Driver	Constant current output, Pf>0.90
Supply Voltage	220-240V/50-60Hz
Ambient Temperature	-20C°/+40C°
Options	Dali 3 hour emergency lighting kit

Color Options

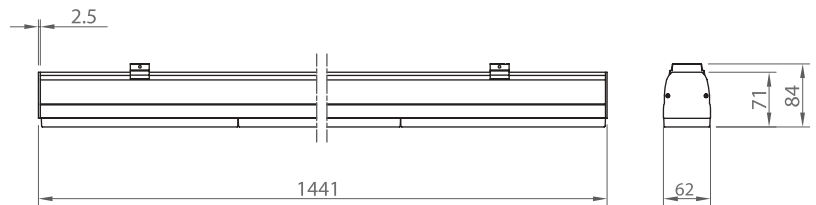
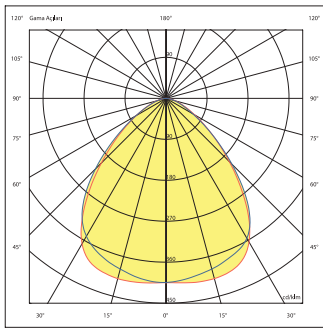
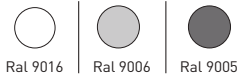

Surface Mounting And Suspension



Steel Suspension Kit



Order Code	W	Lm	CCT	CRI	Kg
72038.15.30.085	65	8530	3000	Ra>80	3,1
72038.15.40.089	65	8900	4000	Ra>80	3,1
72039.15.30.065	53	6635	3000	Ra>80	3,1
72039.15.40.068	53	6825	4000	Ra>80	3,1

RUNNING Trunking System

Running Energy Transfer Body

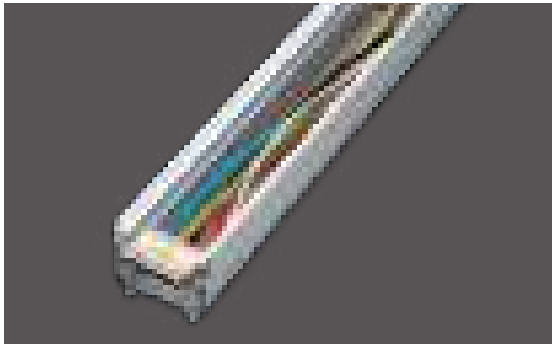

Housing	Extruded aluminum profile with electrostatic coating
Options	Dali 3 hour emergency lighting

* **Body System (Without Cap)**

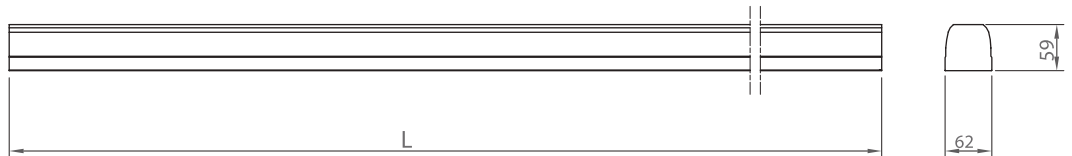

Order Code	Cable	Description	L (mm)	Kg
72530.05.100	5 core	on/off	1436	1,8
72730.05.100	7 core	Dali	1436	1,9
72930.05.100	9 core	Dali + Emergency Kit	1436	2,0
72530.05.200	5 core	on/off	2872	3,6
72730.05.200	7 core	Dali	2872	3,8
72930.05.200	9 core	Dali + Emergency Kit	2872	4,0
72530.05.300	5 core	on/off	4308	5,4
72730.05.300	7 core	Dali	4308	5,7
72930.05.300	9 core	Dali + Emergency Kit	4308	6,0

RUNNING Optic Units

60°

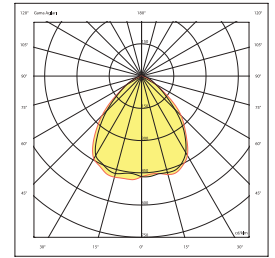

Order Code	W	Lm	CCT	CRI	Kg
72038.15.30.085	65	8530	3000	Ra>80	3,1
72038.15.30.070	53	6635	3000	Ra>80	3,1
72038.15.40.089	65	8900	4000	Ra>80	3,1
72038.15.40.071	53	6825	4000	Ra>80	3,1

Asymmetric

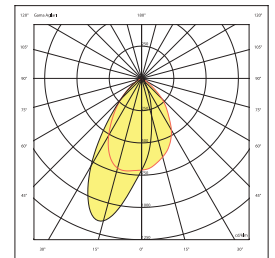

Order Code	W	Lm	CCT	CRI	Kg
72039.15.30.065	53	6635	3000	Ra>80	3,1
72039.15.40.067	53	6825	4000	Ra>80	3,1

Double Asymmetric

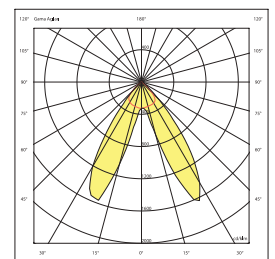
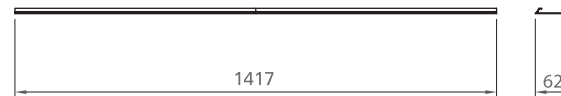

Order Code	W	Lm	CCT	CRI	Kg
72039.15.30.067.N000	53	6635	3000	Ra>80	3,1
72039.15.40.066.N000	53	6825	4000	Ra>80	3,1

Running System Units

Connector

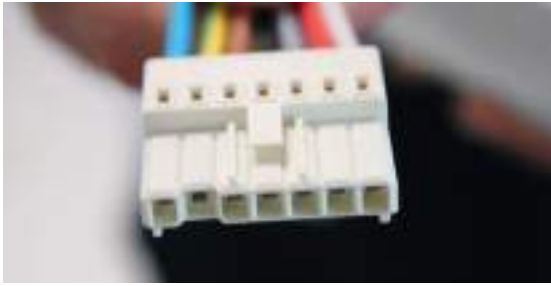

Blind Cover

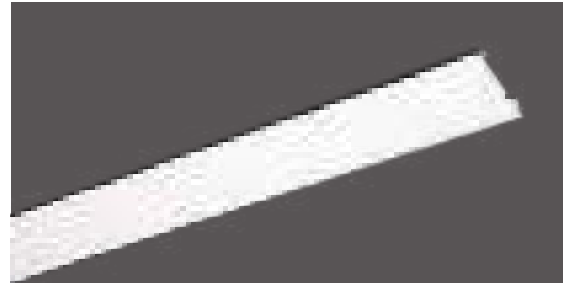

Running Accesories

Joint Piece



Surface Mounting and Suspension Part



End Cap



Steel Suspension Kit



LIGHTLINE-075



Housing	Extruded aluminum profile with electrostatic coating
Optics	Highly transmissive opal PC diffuser
Light Source	High efficacy Mid Power LED with lifetime L80B50 > 50,000h
Driver	Constant current output, Pf>0.90
Supply Voltage	220-240V/50-60Hz
Ambient Temperature	-20C°/+40C°
Options	Dali 3 hour emergency lighting kit

Color Options

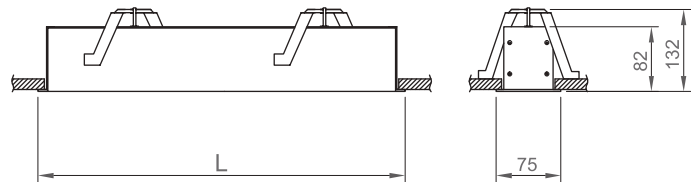
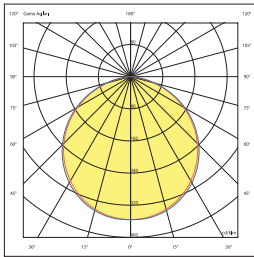
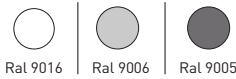

Order Code	W	Lm	K	CRI	L (mm)	Cut-out (mm)	Kg
02155.71.30.015	15	1270	3000	Ra>80	590	65x580	0,9
02155.71.30.021	21	1780	3000	Ra>80	590	65x580	0,9
02155.71.30.023	22	1870	3000	Ra>80	870	65x860	1,4
02155.71.30.032	31	2640	3000	Ra>80	870	65x860	1,4
02155.71.30.031	29	2450	3000	Ra>80	1150	65x1140	1,9
02155.71.30.043	42	3550	3000	Ra>80	1150	65x1140	1,9
02155.71.30.038	36	3040	3000	Ra>80	1430	65x1420	2,3
02155.71.30.053	52	4400	3000	Ra>80	1430	65x1420	2,3
02155.71.30.046	44	3740	3000	Ra>80	1710	65x1700	2,75
02155.71.30.064	62	5250	3000	Ra>80	1710	65x1700	2,75
02155.71.40.016	15	1350	4000	Ra>80	590	65x580	0,9
02155.71.40.022	21	1890	4000	Ra>80	590	65x580	0,9
02155.71.40.024	22	1980	4000	Ra>80	870	65x860	1,4
02155.71.40.033	31	2800	4000	Ra>80	870	65x860	1,4
02155.71.40.032	29	2620	4000	Ra>80	1150	65x1140	1,9
02155.71.40.044	42	3790	4000	Ra>80	1150	65x1140	1,9
02155.71.40.039	36	3240	4000	Ra>80	1430	65x1420	2,3
02155.71.40.055	52	4680	4000	Ra>80	1430	65x1420	2,3
02155.71.40.048	44	3960	4000	Ra>80	1710	65x1700	2,75
02155.71.40.066	62	5580	4000	Ra>80	1710	65x1700	2,75

LIGHTLINE-046

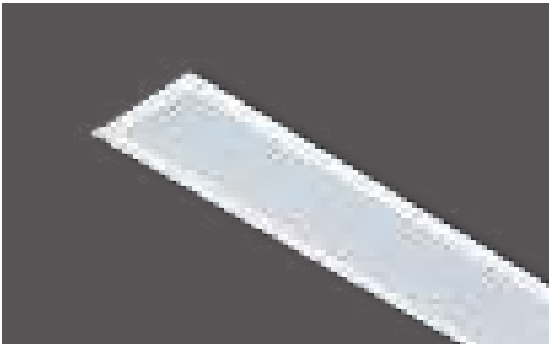

Housing	Extruded aluminum profile with electrostatic coating
Optics	Highly transmissive opal PC diffuser
Light Source	High efficacy Mid Power LED with lifetime L80B50 > 50,000h
Driver	Constant current output, Pf>0.90
Supply Voltage	220-240V/50-60Hz
Ambient Temperature	-20C°/+40C°
Options	Dali 3 hour emergency lighting kit

Color Options

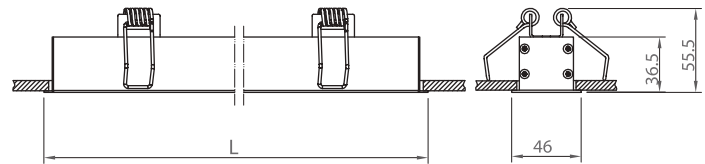
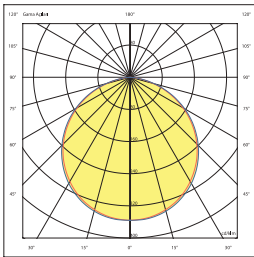
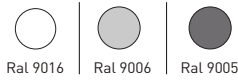

Order Code	W	Lm	K	CRI	L (mm)	Cut-out (mm)	Kg
02155.45.30.015	16	1500	3000	Ra>80	1060	41x1040	1,0
02155.45.40.016	16	1600	4000	Ra>80	1060	41x1040	1,0

3

DOWNLIGHT LIGHTING



Color Options

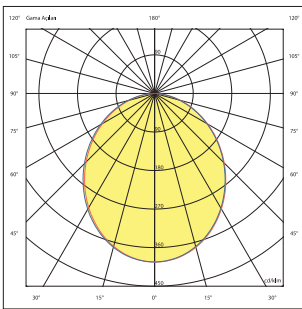
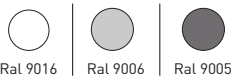

Housing	Die-cast aluminium with electrostatic coating
Optics	Highly transmissive opal diffuser
Light Source	High efficacy Mid Power LED with lifetime L80B50 > 50,000h
Driver	Constant current output, Pf>0.90
Supply Voltage	220-240V/50-60Hz
Ambient Temperature	-20C°/+40C°
Options	Dali 3 hour emergency lighting kit IP 44

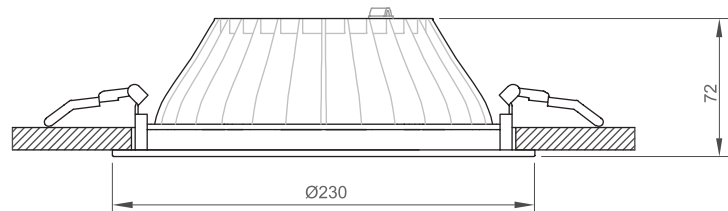

Order Code	W	Lm	CCT	CRI	Cut-out (mm)	Kg
05393.23.30.029	28	2300	3000	Ra>80	Ø215	1,0
05393.23.40.029	28	2400	4000	Ra>80	Ø215	1,0

LUNA 019



Color Options

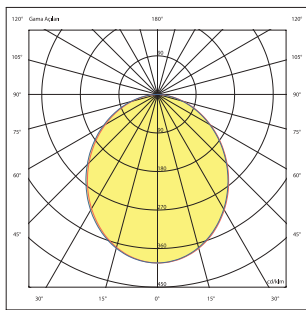

Housing	Die-cast aluminium with electrostatic coating
Optics	Highly transmissive opal diffuser
Light Source	High efficacy Mid Power LED with lifetime L80B50 > 50,000h
Driver	Constant current output, P _f >0.90
Supply Voltage	220-240V/50-60Hz
Ambient Temperature	-20C°/+40C°
Options	Dali 3 hour emergency lighting kit IP 44

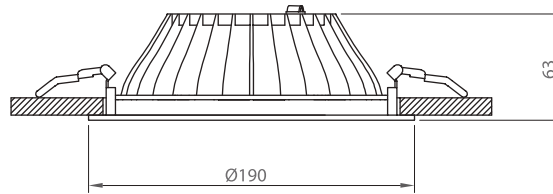

Order Code	W	Lm	CCT	CRI	Cut-out (mm)	Kg
05393.19.30.011	13	1300	3000	Ra>80	Ø175	0,9
05393.19.30.015	19	1900	3000	Ra>80	Ø175	0,9
05393.19.40.012	13	1370	4000	Ra>80	Ø175	0,9
05393.19.40.016	19	2000	4000	Ra>80	Ø175	0,9

LUNA IP65



Housing	Die-cast aluminium with electrostatic coating
Optics	Highly transmissive opal diffuser
Light Source	High efficacy Mid Power LED with lifetime L80B50 > 50,000h
Driver	Constant current output, Pf>0.90
Supply Voltage	220-240V/50-60Hz
Ambient Temperature	-20C°/+40C°
Options	Dali 3 hour emergency lighting kit

Color Options

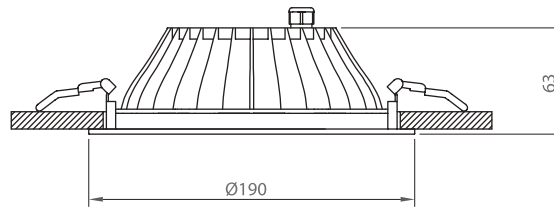
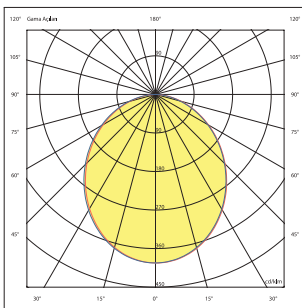
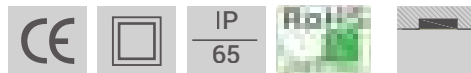

OPTIONS

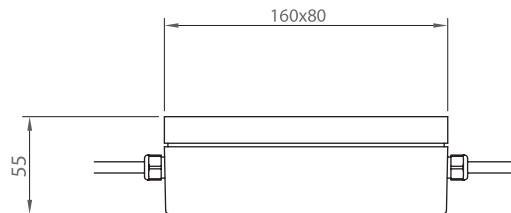

Order Code	W	Lm	CCT	CRI	Cut-out (mm)	Kg
05395.19.30.011	13	1300	3000	Ra>80	Ø175	0,9
05395.19.30.015	19	1900	3000	Ra>80	Ø175	0,9
05395.19.40.012	13	1370	4000	Ra>80	Ø175	0,9
05395.19.40.016	19	2000	4000	Ra>80	Ø175	0,9

SNOW 023



Housing	Die-cast aluminium with electrostatic coating
Optics	Highly transmissive opal diffuser
Light Source	High efficacy Mid Power LED with lifetime L80B50 > 50,000h
Driver	Constant current output, Pf>0.90
Supply Voltage	220-240V/50-60Hz
Ambient Temperature	-20C°/+40C°
Options	Dali 3 hour emergency lighting kit

Color Options

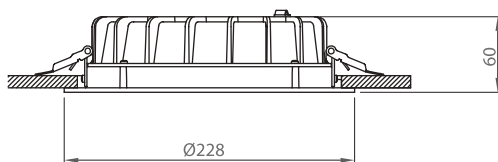
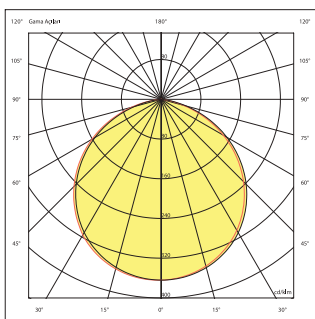

Order Code	W	Lm	CCT	CRI	Cut-out (mm)	Kg
05397.23.30.033	30	3350	3000	Ra>80	Ø210	0,9
05397.23.40.035	30	3500	4000	Ra>80	Ø210	0,9

017 SNOW

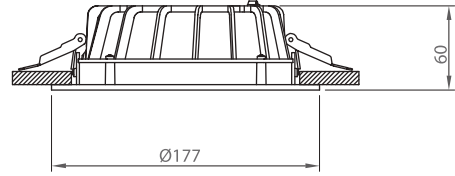

Color Options

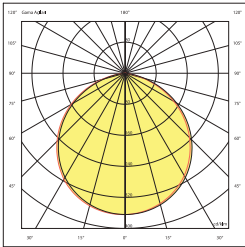

Order Code	W	Lm	CCT	CRI	Cut-out (mm)	Kg
05397.19.30.018	19	2120	3000	Ra>80	Ø160	0,7
05397.19.40.019	19	2216	4000	Ra>80	Ø160	0,7

014 SNOW

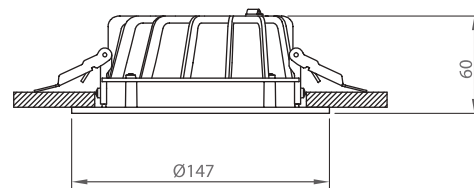

Color Options

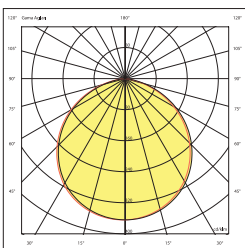

Order Code	W	Lm	CCT	CRI	Cut-out (mm)	Kg
05397.15.30.010	10	1100	3000	Ra>80	Ø130	0,6
05397.15.40.010	10	1160	4000	Ra>80	Ø130	0,6

SLOT 023



Housing	Die-cast aluminium with electrostatic coating
Optics	Highly transmissive opal diffuser
Light Source	High efficacy COB LED with lifetime L80B50 > 50,000h
Driver	Constant current output, Pf>0.90
Supply Voltage	220-240V/50-60Hz
Ambient Temperature	-20C°/+40C°
Options	Dali 3 hour emergency lighting kit

Color Options

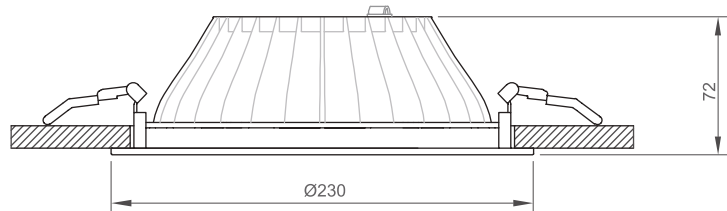
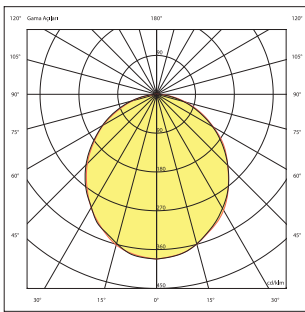

Order Code	W	Lm	CCT	CRI	Cut-out (mm)	Kg
05396.23.30.024	28	2400	3000	Ra>80	Ø215	1,0
05396.23.30.035	32	3500	3000	Ra>80	Ø215	1,0
05396.23.40.025	28	2500	4000	Ra>80	Ø215	1,0
05396.23.40.036	32	3600	4000	Ra>80	Ø215	1,0

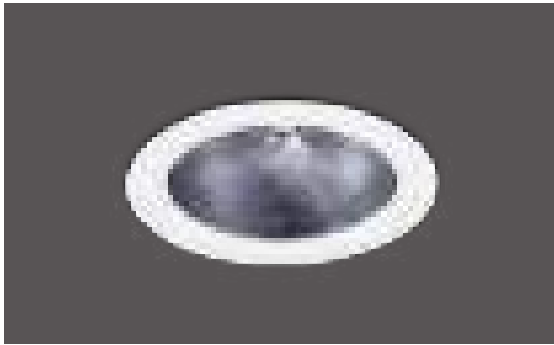

Color Options

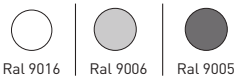

Housing	Die-cast aluminium with electrostatic coating
Optics	Highly transmissive opal diffuser
Light Source	High efficacy COB LED with lifetime L80B50 > 50,000h
Driver	Constant current output, Pf>0.90
Supply Voltage	220-240V/50-60Hz
Ambient Temperature	-20C°/+40C°
Options	Dali 3 hour emergency lighting kit

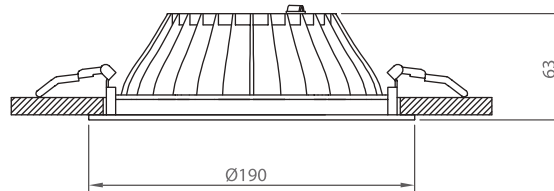
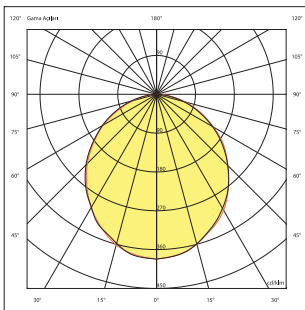

Order Code	W	Lm	CCT	CRI	Cut-out (mm)	Kg
05396.19.30.012	13	1200	3000	Ra>80	Ø175	0,9
05396.19.30.016	19	1600	3000	Ra>80	Ø175	0,9
05396.19.40.013	13	1300	4000	Ra>80	Ø175	0,9
05396.19.40.017	19	1600	4000	Ra>80	Ø175	0,9

VIVID



Housing	Die-cast aluminium with electrostatic coating
Reflector	Highly efficient vacuumed aluminum coated PC reflector and deglaring diffuser combined with thermoplastic reflector (UGR<16)
Light Source	High efficacy Mid Power LED with lifetime L80B50 > 50,000h
Driver	Constant current output, Pf>0.90
Supply Voltage	220-240V/50-60Hz
Ambient Temperature	-20C°/+40C°
Options	Dali 3 hour emergency lighting kit

Color Options

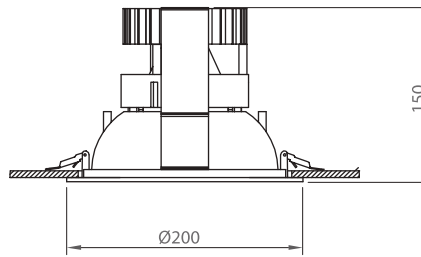
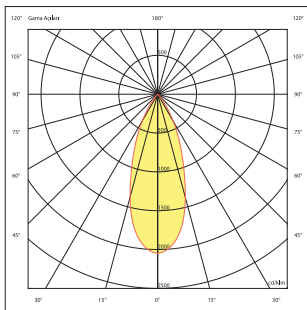

Order Code	W	Lm	Beam Angle	CCT	CRI	Cut-out (mm)	Kg
05558.13.30.021	30	2550	45°	3000	Ra>80	Ø185	0,75
05558.13.40.021	30	2700	45°	4000	Ra>80	Ø185	0,75

CANVAS



Housing	Electrostatic coated steel sheet
Optics	Highly transmissive opal diffuser
Light Source	High efficacy Mid Power LED with lifetime L80B50 > 50,000h
Driver	Constant current output, Pf>0.90
Supply Voltage	220-240V/50-60Hz
Ambient Temperature	-20C°/+40C°
Options	Dali 3 hour emergency lighting kit

Color Options

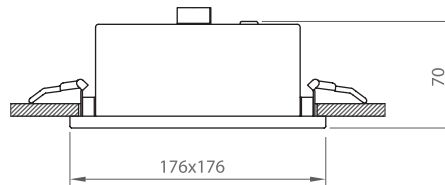
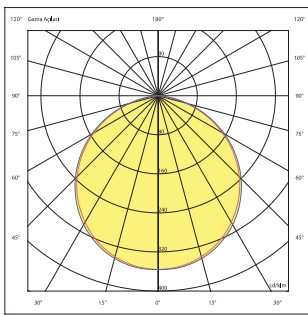
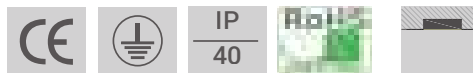
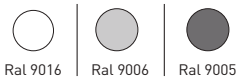

Order Code	W	Lm	CCT	CRI	Cut-out (mm)	Kg
05247.22.30.015	13	1350	3000	Ra>80	165x160	0,6
05247.22.30.021	18	1850	3000	Ra>80	165x160	0,6
05247.22.40.016	13	1430	4000	Ra>80	165x160	0,6
05247.22.40.022	18	1920	4000	Ra>80	165x160	0,6

LUNA-T



Color Options



Housing	Electrostatic coated aluminum
Optics	Highly transmissive opal diffuser
Light Source	High efficacy SMD Mid Power LED with lifetime L80B50 > 50,000h
Driver	Constant current output, Pf>0.90
Supply Voltage	220-240V/50-60Hz
Ambient Temperature	-20C°/+40C°
Options	Dali 3 hour emergency lighting kit

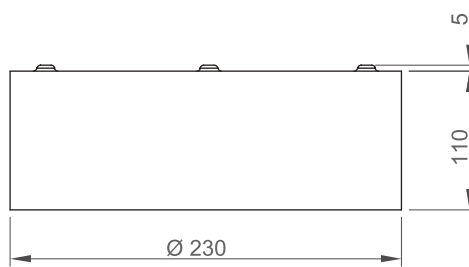
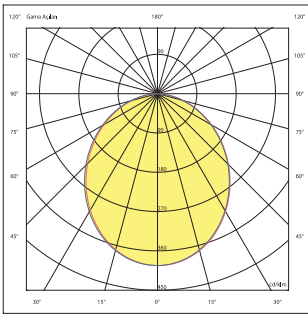
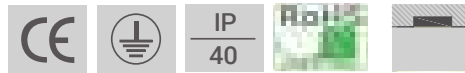

Order Code	W	Lm	CCT	CRI	Kg
03170.23.30.016	18	1620	3000	Ra>80	1,2
03170.23.30.023	23	2232	3000	Ra>80	1,2
03170.23.40.017	18	1688	4000	Ra>80	1,2
03170.23.40.024	23	2325	4000	Ra>80	1,2

CANVAS-T



Housing	Electrostatic coated steel sheet
Optics	Highly transmissive opal diffuser
Light Source	High efficacy SMD Mid Power LED with lifetime L80B50 > 50,000h
Driver	Constant current output, Pf>0.90
Supply Voltage	220-240V/50-60Hz
Ambient Temperature	-20C°/+40C°
Options	Dali 3 hour emergency lighting kit

Color Options

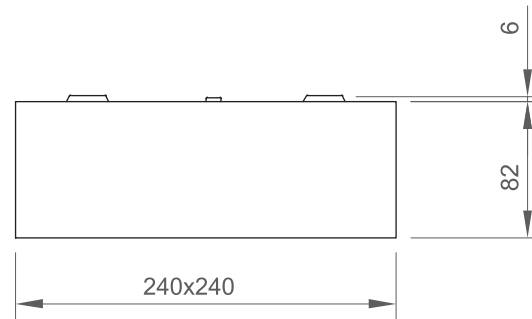
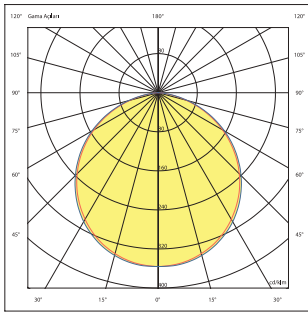
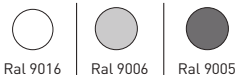

Order Code	W	Lm	CCT	CRI	Kg
05250.22.30.015	13	1350	3000	Ra>80	1,1
05250.22.30.021	18	1850	3000	Ra>80	1,1
05250.22.40.016	13	1430	4000	Ra>80	1,1
05250.22.40.022	18	1920	4000	Ra>80	1,1



4 | SPOT LIGHTING

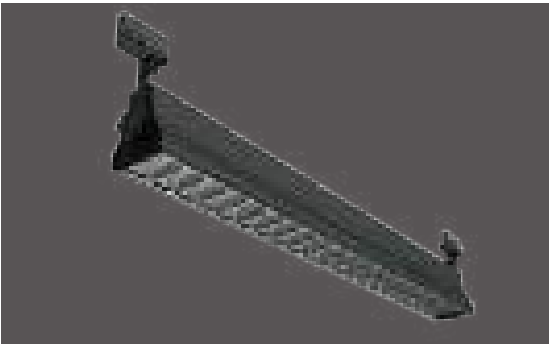

Housing	Extruded aluminum profile with electrostatic coating
Optics	Acrylic optic lens, painted reflector
Reflector	Grey electrostatic coated louvre and matte anodized aluminum
Light Source	High efficacy Mid Power LED with lifetime L80B50 > 50,000h
Driver	Constant current output, Pf>0.90
Supply Voltage	220-240V/50-60Hz
Ambient Temperature	-20C°/+40C°
Options	Dali

Color Options

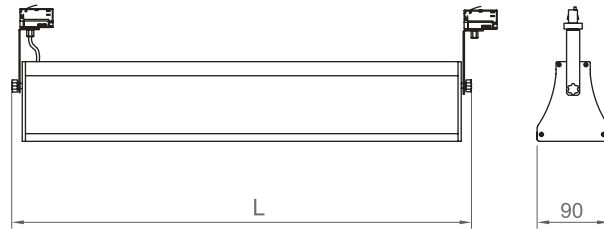
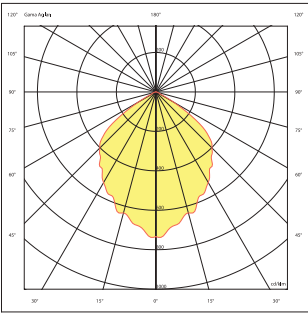
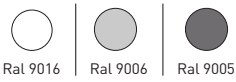

Order Code	W	Lm	Beam Angle	CCT	CRI	L (mm)	Kg
01196.91.30.031	28	3130	55°	3000	Ra>80	600	2,1
01196.91.30.046	42	4656	55°	3000	Ra>80	900	3,1
01196.91.30.053	49	5330	55°	3000	Ra>80	1200	4,2
01196.91.40.033	28	3260	55°	4000	Ra>80	600	2,1
01196.91.40.048	42	4850	55°	4000	Ra>80	900	3,1
01196.91.40.055	49	5550	55°	4000	Ra>80	1200	4,2

DUET-R



Color Options

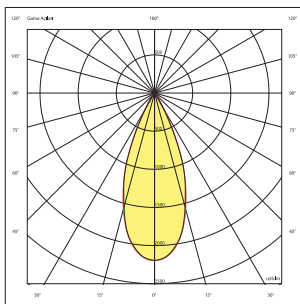

Housing	Extruded aluminum profile with electrostatic coating
Reflector	Highly efficient, aluminum coated, vacuumed PC reflector and deglaring (UGR<16)
Light Source	High efficacy High Power LED with lifetime L80B50 > 50,000h
Driver	Constant current output, Pf>0.90
Supply Voltage	220-240V/50-60Hz
Ambient Temperature	-20C°/+40C°

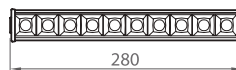
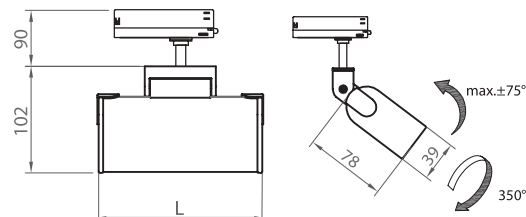

Order Code	W	Lm	Beam Angle	CCT	CRI	L	Kg
01189.37.30.011	11	1100	36°	3000	Ra>80	145	0,45
01189.37.30.021	22	2200	36°	3000	Ra>80	280	0,75
01189.37.40.012	33	3300	36°	3000	Ra>80	430	1,15
01189.37.40.022	11	1200	36°	4000	Ra>80	145	0,45
01189.37.30.036	22	2400	36°	4000	Ra>80	280	0,75
01189.37.40.038	33	3600	36°	3000	Ra>80	430	1,15

DUET-T



Housing	Extruded aluminum profile with electrostatic coating
Reflector	Highly efficient, aluminum coated, vacuumed PC reflector and deglaring (UGR<16)
Light Source	High efficacy High Power LED with lifetime L80B50 > 50,000h
Driver	Constant current output, Pf>0.90
Supply Voltage	220-240V/50-60Hz
Ambient Temperature	-20C°/+40C°

Color Options

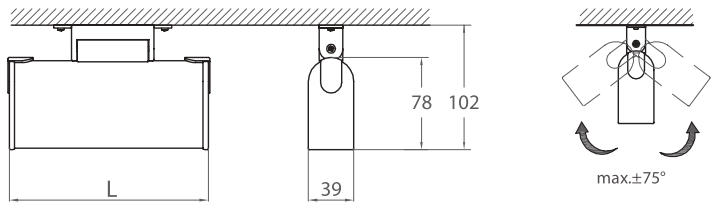
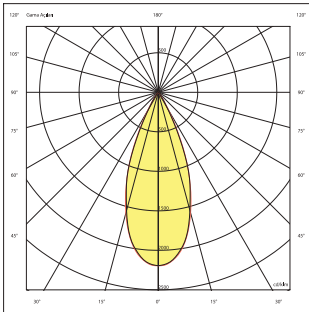
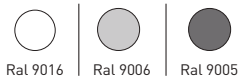

Order Code	W	Lm	Beam Angle	CCT	CRI	L	Kg
01199.37.30.021	22	2200	36°	3000	Ra>80	280	0,7
01199.37.40.012	33	3300	36°	3000	Ra>80	430	1,1
01199.37.30.036	22	2400	36°	4000	Ra>80	280	0,7
01199.37.40.038	33	3600	36°	3000	Ra>80	430	1,1

MODUS DC



Housing	Extruded aluminum profile with electrostatic coating
Reflector	Anodized aluminum reflector
Light Source	High efficacy COB LED with lifetime L80B50 > 50,000h
Driver	Constant current output, Pf>0.90
Supply Voltage	220-240V/50-60Hz
Ambient Temperature	-20C°/+40C°

Color Options

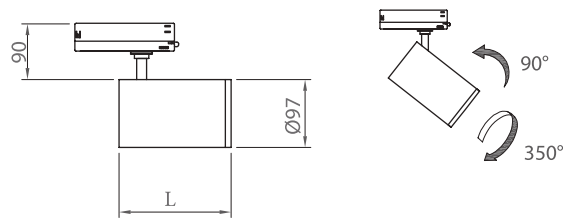
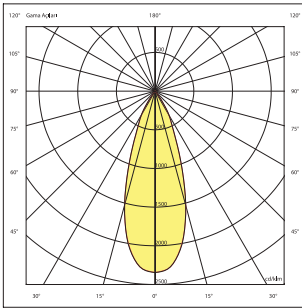
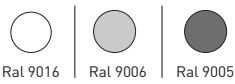

Order Code	W	Lm	Beam Angle	CCT	CRI	L	Kg
05638.97.30.027	30	3330	12°	3000	Ra>80	170	1,2
05638.97.30.028	30	3330	24°	3000	Ra>80	170	1,2
05638.97.30.029	30	3330	36°	3000	Ra>80	170	1,2
05638.97.30.016	19	2110	12°	3000	Ra>80	150	1,2
05638.97.30.017	19	2110	24°	3000	Ra>80	150	1,2
05638.97.30.018	19	2110	36°	3000	Ra>80	150	1,2
05638.97.40.028	30	3510	12°	4000	Ra>80	170	1,2
05638.97.40.029	30	3510	24°	4000	Ra>80	170	1,2
05638.97.40.030	30	3510	36°	4000	Ra>80	170	1,2
05638.97.40.017	19	2220	12°	4000	Ra>80	150	1,2
05638.97.40.018	19	2220	24°	4000	Ra>80	150	1,2
05638.97.40.019	19	2220	36°	4000	Ra>80	150	1,2

MODUS



Housing	Extruded aluminum profile with electrostatic coating
Reflector	Anodized aluminum reflector
Light Source	High efficacy COB LED with lifetime L80B50 > 50,000h
Driver	Constant current output, Pf>0.90
Supply Voltage	220-240V/50-60Hz
Ambient Temperature	-20C°/+40C°
Options	Dali

Color Options

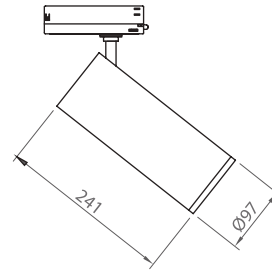
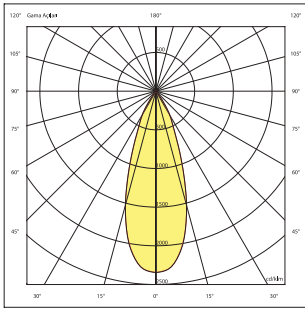
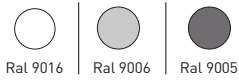

Order Code	W	Lm	Beam Angle	CCT	CRI	Kg
05628.97.30.025	27	2960	12°	3000	Ra>80	1,2
05628.97.30.026	27	2960	24°	3000	Ra>80	1,2
05628.97.30.027	27	2960	38°	3000	Ra>80	1,2
05628.97.30.016	19	2110	12°	3000	Ra>80	1,2
05628.97.30.017	19	2110	24°	3000	Ra>80	1,2
05628.97.30.018	19	2110	38°	3000	Ra>80	1,2
05628.97.40.026	27	3115	12°	4000	Ra>80	1,2
05628.97.40.027	27	3115	24°	4000	Ra>80	1,2
05628.97.40.028	27	3115	38°	4000	Ra>80	1,2
05628.97.40.017	19	2220	12°	4000	Ra>80	1,2
05628.97.40.018	19	2220	24°	4000	Ra>80	1,2
05628.97.40.019	19	2220	38°	4000	Ra>80	1,2

MODUSBOX



Housing	Extruded aluminum profile with electrostatic coating
Reflector	Anodized aluminum reflector
Light Source	High efficacy COB LED with lifetime L80B50 > 50,000h
Driver	Constant current output, Pf>0.90
Supply Voltage	220-240V/50-60Hz
Ambient Temperature	-20C°/+40C°
Options	Dali

Color Options

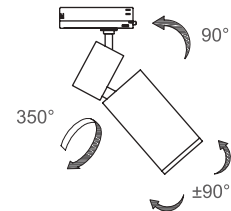
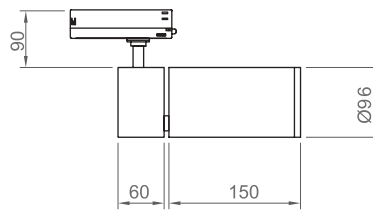
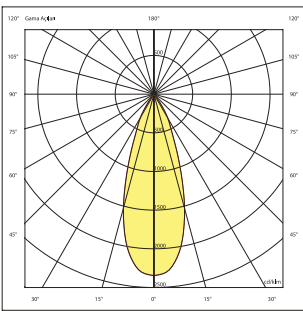
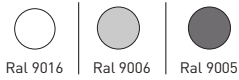

Order Code	W	Lm	Beam Angle	CCT	CRI	L	Kg
05678.97.30.027	30	3330	12°	3000	Ra>80	170	1,5
05678.97.30.028	30	3330	24°	3000	Ra>80	170	1,5
05678.97.30.029	30	3330	36°	3000	Ra>80	170	1,5
05678.97.30.016	19	2110	12°	3000	Ra>80	150	1,5
05678.97.30.017	19	2110	24°	3000	Ra>80	150	1,5
05678.97.30.018	19	2110	36°	3000	Ra>80	150	1,5
05678.97.40.028	30	3510	12°	4000	Ra>80	170	1,5
05678.97.40.029	30	3510	24°	4000	Ra>80	170	1,5
056.78.97.40.030	30	3510	36°	4000	Ra>80	170	1,5
05678.97.40.017	19	2220	12°	4000	Ra>80	150	1,5
05678.97.40.018	19	2220	24°	4000	Ra>80	150	1,5
05678.97.40.019	19	2220	36°	4000	Ra>80	150	1,5

SPARROW



Housing	Extruded aluminum profile with electrostatic coating
Reflector	Anodized aluminum reflector
Light Source	High efficacy COB LED with lifetime L80B50 > 50,000h
Driver	Constant current output, Pf>0.90
Supply Voltage	220-240V/50-60Hz
Ambient Temperature	-20C°/+40C°
Options	Dali

Color Options

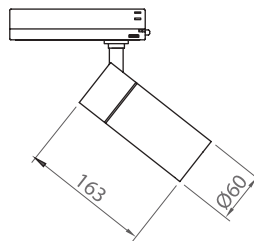
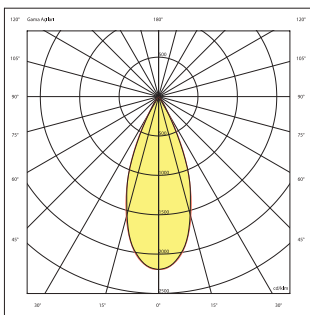

Order Code	W	Lm	Beam Angle	CCT	CRI	Kg
05668.80.30.017	15	1720	24°	3000	Ra>80	1,2
05668.80.30.021	20	2100	24°	3000	Ra>80	1,2
05668.80.40.018	15	1820	24°	4000	Ra>80	1,2
05668.80.40.022	20	2230	24°	4000	Ra>80	1,2



DRAGON



Housing	Die-cast aluminum with electrostatic coating
Reflector	Glossary anodized aluminum reflector
Light Source	MacAdam Step-3 high efficacy COB LED with lifetime L80B50 > 50,000h
Driver	Constant current output, Pf>0.90
Supply Voltage	220-240V/50-60Hz
Ambient Temperature	-20C°/+40C°
Options	Dali 3 hour emergency lighting kit

Color Options

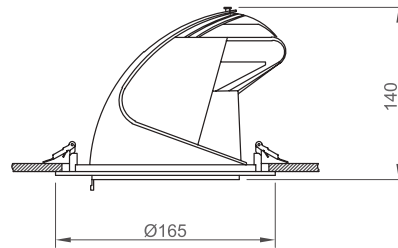
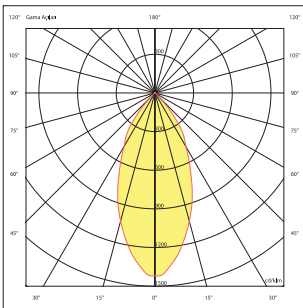
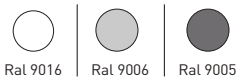

Order Code	W	Lm	Beam Angle	CCT	CRI	Cut-out (mm)	Kg
05310.16.30.032	30	3200	24°	3000	Ra>80	Ø150	1,0
05310.16.40.034	30	3400	24°	4000	Ra>80	Ø150	1,0

ADELLA K2

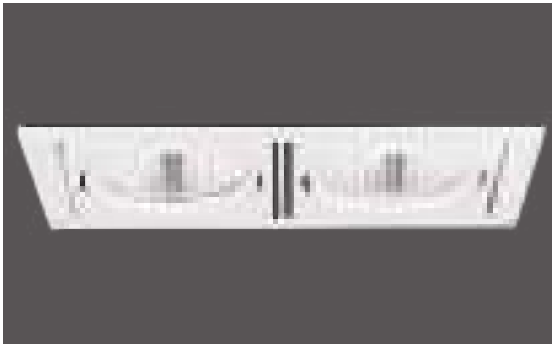

Housing	Die-cast aluminum with electrostatic coating
Reflector	Anodized aluminum reflector
Glass	Clear tempered glass
Light Source	High efficacy COB LED with lifetime L80B50 > 50,000h
Driver	Constant current output, Pf>0.90
Supply Voltage	220-240V/50-60Hz
Ambient Temperature	-20C°/+40C°
Options	Dali 3 hour emergency lighting kit

Color Options

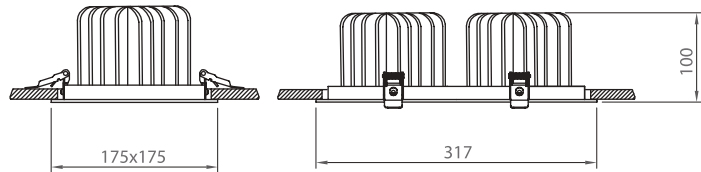
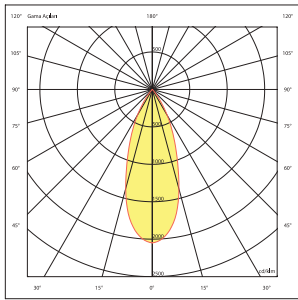

Order Code	W	Beam Angle	Lm	CCT	CRI	Cut-out (mm)	Kg
52682.13.30.030	26	45°	3000	3000	Ra>80	160x302	1,2
52682.13.30.042	36	45°	4200	3000	Ra>80	160x302	1,2
52682.13.30.074	68	45°	7400	3000	Ra>80	160x302	1,2
52682.13.40.032	26	45°	3200	4000	Ra>80	160x302	1,2
52682.13.40.044	36	45°	4400	4000	Ra>80	160x302	1,2
52682.13.40.078	68	45°	7800	4000	Ra>80	160x302	1,2

STAR



Housing	Die-cast aluminum with electrostatic coating
Reflector	Anodized aluminum reflector
Light Source	High efficacy COB LED with lifetime L80B50 > 50,000h
Driver	Constant current output, Pf>0.90
Supply Voltage	220-240V/50-60Hz
Ambient Temperature	-20C°/+40C°
Options	Dali 3 hour emergency lighting kit

Color Options

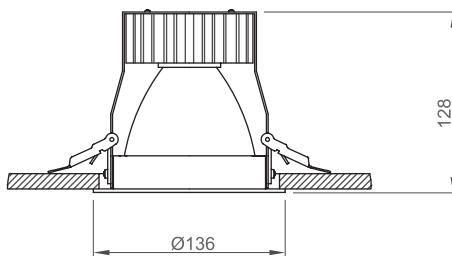
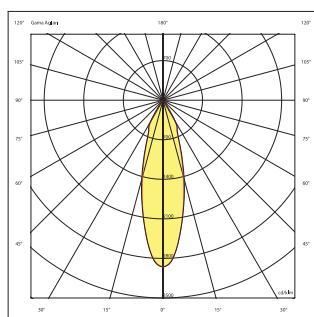
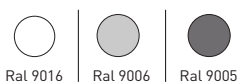

Order Code	W	Lm	Beam Angle	CCT	CRI	Cut-out (mm)	Kg
05110.13.30.030	28	2400	38°	3000	Ra>80	Ø120	0.7
05110.13.40.032	28	2500	38°	4000	Ra>80	Ø120	0.7

STAR MINI

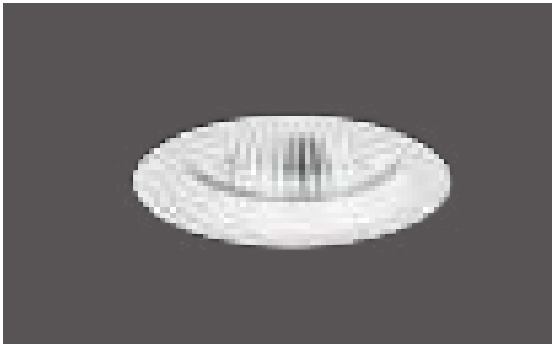

Housing	Die-cast aluminum with electrostatic coating
Reflector	Anodized aluminum reflector
Light Source	High efficacy COB LED with lifetime L80B50 > 50,000h
Driver	Constant current output, P _f >0.90
Supply Voltage	220-240V/50-60Hz
Ambient Temperature	-20C°/+40C°
Options	Dali 3 hour emergency lighting kit

Color Options

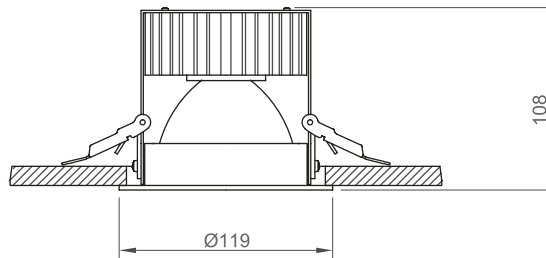
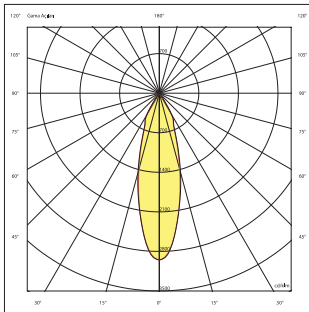
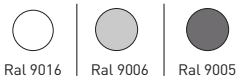

Order Code	W	Beam Angle	Lm	CCT	CRI	Cut-out (mm)	Kg
05110.11.30.023	20	38°	1700	3000	Ra>80	Ø106	0.6
05110.11.40.024	20	38°	1800	4000	Ra>80	Ø106	0.6

DARKPIT 140



Color Options



Housing	Electrostatic coated steel frame and aluminum heatsink
Reflector	Highly efficient vacuumed aluminum coated PC reflector and deglaring diffuser combined with thermoplastic reflector (UGR<16)
Light Source	High efficacy COB LED with lifetime L80B50 > 50,000h
Driver	Constant current output, Pf>0.90
Supply Voltage	220-240V/50-60Hz
Ambient Temperature	-20C°/+40C°
Options	Dali 3 hour emergency lighting kit

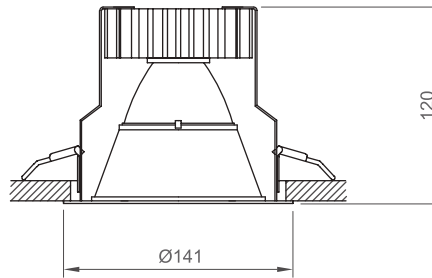
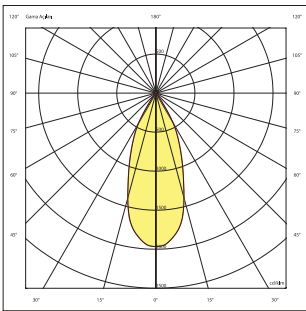

Order Code	W	Lm	Beam Angle	CCT	CRI	Cut-out (mm)	Kg
05111.14.30.023	19	1700	45°	3000	Ra>80	Ø130	0.6
05111.14.40.023	19	1800	45°	4000	Ra>80	Ø130	0.6

118 DARKPIT

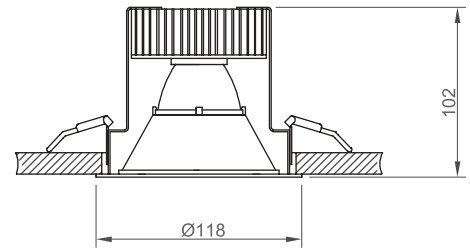

Color Options

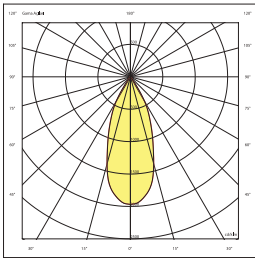
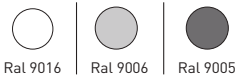

Order Code	W	Lm	Beam Angle	CCT	CRI	Cut-out (mm)	Kg
05111.11.30.015	14	1250	45°	3000	Ra>80	Ø105	0.5
05111.11.40.015	14	1350	45°	4000	Ra>80	Ø105	0.5

090 DARKPIT

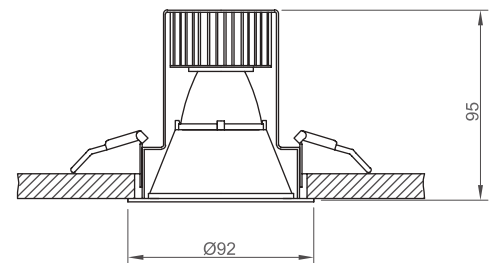

Color Options

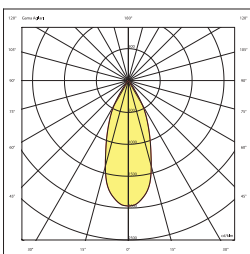

Order Code	W	Lm	Beam Angle	CCT	CRI	Cut-out (mm)	Kg
05111.09.30.010	10	900	45°	3000	Ra>80	Ø82	0.3
05111.09.40.011	10	950	45°	4000	Ra>80	Ø82	0.3

SILVERPIT 140



Color Options



Housing	Electrostatic coated steel frame and aluminum heatsink
Reflector	Highly efficient vacuumed aluminum coated PC reflector and deglaring diffuser combined with thermoplastic reflector (UGR<16)
Light Source	High efficacy COB LED with lifetime L80B50 > 50,000h
Driver	Constant current output, Pf>0.90
Supply Voltage	220-240V/50-60Hz
Ambient Temperature	-20C°/+40C°
Options	Dali 3 hour emergency lighting kit

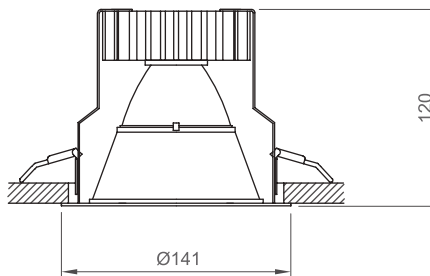
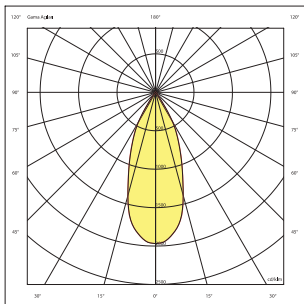

Order Code	W	Lm	Beam Angle	CCT	CRI	Cut-out (mm)	Kg
05113.14.30.022	19	1800	45°	3000	Ra>80	Ø130	0.6
05113.14.40.023	19	1900	45°	4000	Ra>80	Ø130	0.6

118 SILVERPIT

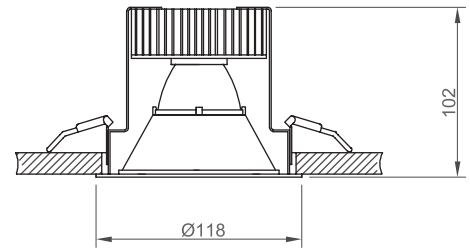
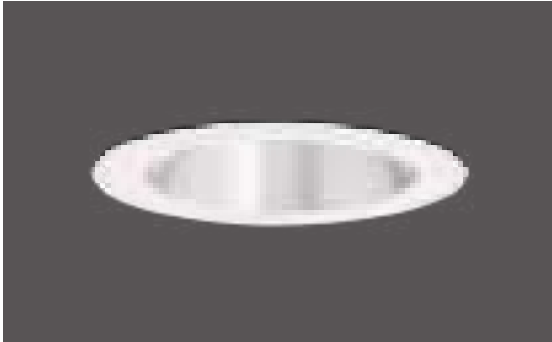

Color Options

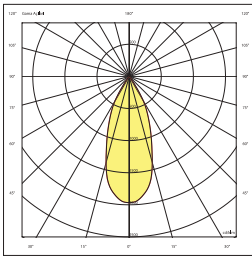

Order Code	W	Lm	Beam Angle	CCT	CRI	Cut-out (mm)	Kg
05113.11.30.014	14	1300	45°	3000	Ra>80	Ø105	0.5
05113.11.40.015	14	1400	45°	4000	Ra>80	Ø105	0.5

090 SILVERPIT

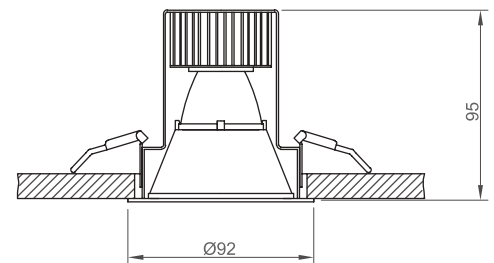

Color Options

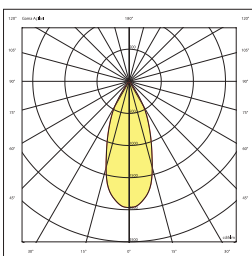

Order Code	W	Lm	Beam Angle	CCT	CRI	Cut-out (mm)	Kg
05111.09.30.010	10	950	45°	3000	Ra>80	Ø82	0.3
05111.09.40.011	10	1000	45°	4000	Ra>80	Ø82	0.3



Housing	Die-cast aluminum with electrostatic coating
Reflector	Vacuumed aluminum coated PC reflector, clear lens
Light Source	High efficacy COB LED with lifetime L80B50 > 50,000h
Driver	Constant current output, Pf>0.90
Supply Voltage	220-240V/50-60Hz
Ambient Temperature	-20C°/+40C°
Options	Dali 3 hour emergency lighting kit

Color Options



Ral 9016

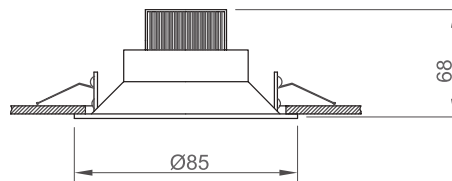
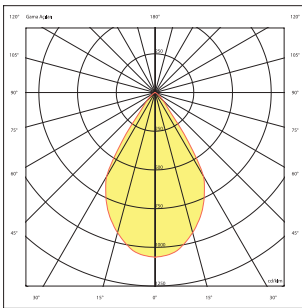

Order Code	W	Lm	Beam Angle	CCT	CRI	Cut-out (mm)	Kg
05321.08.30.006	7	650	60°	3000	Ra>80	Ø75	0,2
05321.08.30.010	11	1000	60°	3000	Ra>80	Ø75	0,2
05321.08.40.007	7	700	60°	4000	Ra>80	Ø75	0,2
05321.08.40.011	11	1100	60°	4000	Ra>80	Ø75	0,2

CELL



Housing	Die-cast aluminum with electrostatic coating
Reflector	Vacuumed aluminum coated PC reflector, clear lens
Light Source	High efficacy COB LED with lifetime L80B50 > 50,000h
Driver	Constant current output, Pf>0.90
Supply Voltage	220-240V/50-60Hz
Ambient Temperature	-20C°/+40C°
Options	Dali 3 hour emergency lighting kit

Color Options



Ral 9016

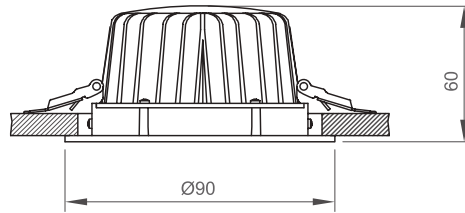
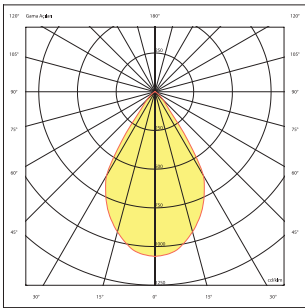

Order Code	W	Lm	Beam Angle	CCT	CRI	Cut-out (mm)	Kg
05324.09.30.007	7	670	55°	3000	Ra>80	80	0.2
05324.09.30.010	11	1000	55°	3000	Ra>80	80	0.2
05324.09.40.007	7	700	55°	4000	Ra>80	80	0.2
05324.09.40.011	11	1100	55°	4000	Ra>80	80	0.2

DROP



Color Options



Ral 9016

Housing	Die-cast aluminum with electrostatic coating
Reflector	Glossary anodized aluminum reflector
Glass	Clear tempered glass
Light Source	High efficacy COB LED with lifetime L80B50 > 50,000h
Driver	Constant current output, Pf>0.90
Supply Voltage	220-240V/50-60Hz
Ambient Temperature	-20C°/+40C°
Options	Dali 3 hour emergency lighting kit

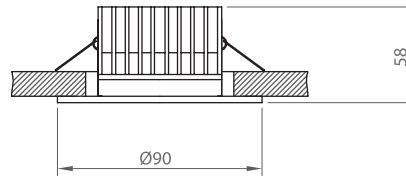
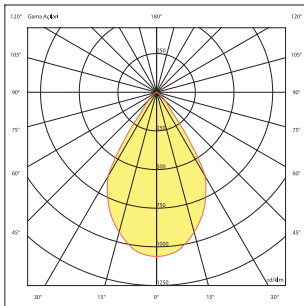

Order Code	W	Lm	Beam Angle	CCT	CRI	Cut-out (mm)	Kg
05378.90.30.007	7	670	60°	3000	Ra>80	Ø75	0.6
05378.90.30.010	12	1000	60°	3000	Ra>80	Ø75	0.6
05378.90.40.007	7	700	60°	4000	Ra>80	Ø75	0.6
05378.90.40.010	12	1050	60°	4000	Ra>80	Ø75	0.6

MINO



Housing	Die-cast aluminum with electrostatic coating
Reflector	Optic lens
Light Source	High efficacy COB LED with lifetime L80B50 > 50,000h
Driver	Constant current output, Pf>0.90
Supply Voltage	220-240V/50-60Hz
Ambient Temperature	-25C°/+40C°
Options	Dali 3 hour emergency lighting kit

Color Options



Ral 9016

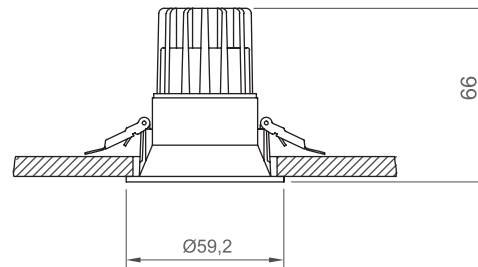
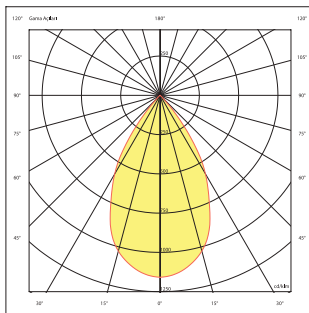

Order Code	W	Lm	Beam Angle	CCT	CRI	Cut-out (mm)	Kg
05112.06.30.006	6	570	38°	3000	Ra>80	Ø55	0,1
05112.06.40.006	6	620	38°	4000	Ra>80	Ø55	0,1

HOLLOW



Housing	Die-cast aluminum with electrostatic coating
Reflector	Vacuumed aluminum coated PC reflector, clear lens
Light Source	High efficacy COB LED with lifetime L80B50 > 50,000h
Driver	Constant current output, Pf>0.90
Supply Voltage	220-240V/50-60Hz
Ambient Temperature	-25C°/+40C°
Options	Dali 3 hour emergency lighting kit

Color Options

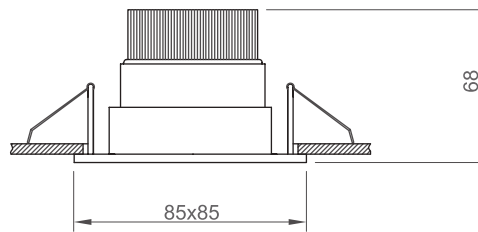
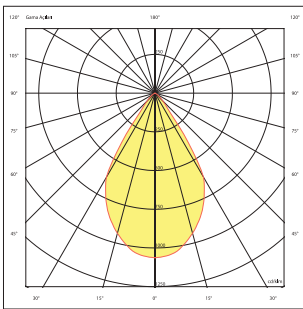

Order Code	W	Lm	Beam Angle	CCT	CRI	Cut-out (mm)	Kg
05318.88.30.007	7	650	60°	3000	Ra>80	75x75	0.2
05318.88.30.011	11	1000	60°	3000	Ra>80	75x75	0.2
05318.88.40.007	7	700	60°	4000	Ra>80	75x75	0.2
05318.88.40.011	11	1100	60°	4000	Ra>80	75x75	0.2

STYLED

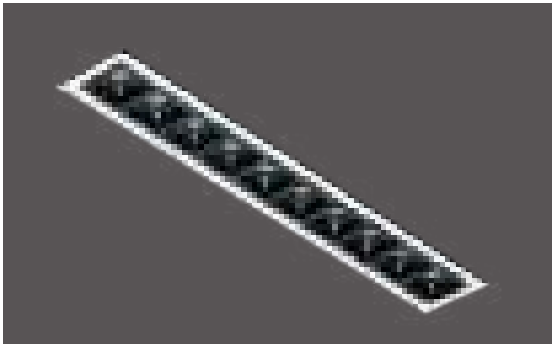

Housing	Extruded aluminum profile with electrostatic coating
Reflector	Highly efficient vacuumed aluminum coated PC reflector and deglaring diffuser combined with thermoplastic reflector (UGR<16)
Light Source	High efficacy Mid Power LED with lifetime L80B50 > 50,000h
Driver	Constant current output, Pf>0.90
Supply Voltage	220-240V/50-60Hz
Ambient Temperature	-20C°/+40C°
Options	Dali 3 hour emergency lighting kit

Color Options

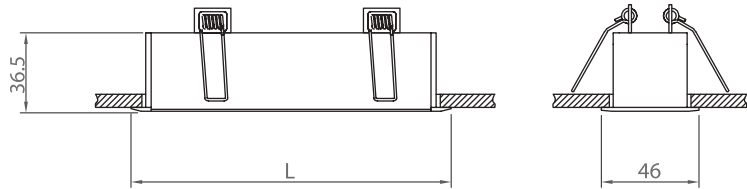
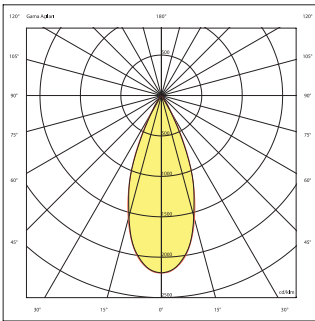

Order Code	W	Lm	Beam Angle	CCT	CRI	L	Cut-out (mm)	Kg
05249.16.30.004	11	1100	36°	3000	Ra>80	150	142x38	0,3
05249.16.40.005	22	2200	36°	4000	Ra>80	285	278x38	0,6
05249.16.40.005	11	1200	36°	4000	Ra>80	150	142x38	0,3
05249.16.40.005	22	2400	36°	4000	Ra>80	285	278x38	0,6

STYLED-W

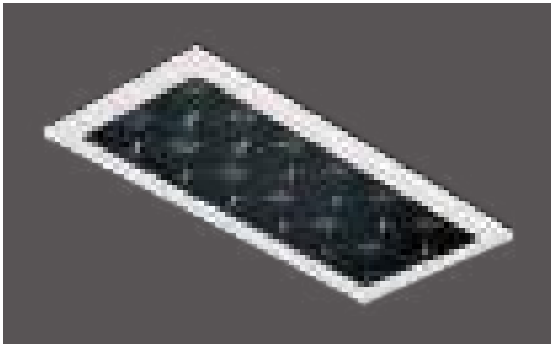

Housing	Electrostatic coated steel sheet
Reflector	Highly efficient vacuumed aluminum coated PC reflector and deglaring diffuser combined with thermoplastic reflector (UGR<17)
Light Source	High efficacy Mid Power LED with lifetime L80B50 > 50,000h
Driver	Constant current output, Pf>0.90
Supply Voltage	220-240V/50-60Hz
Ambient Temperature	-20C°/+40C°
Options	Dali 3 hour emergency lighting kit

Color Options

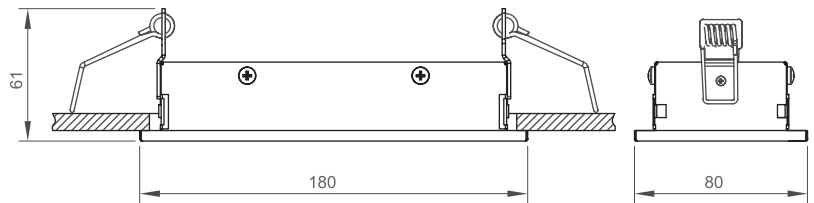
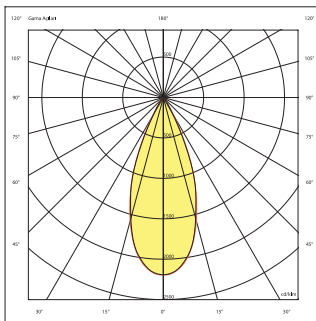
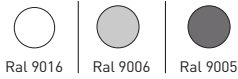

Order Code	W	Lm	Beam Angle	CCT	CRI	Cut-out (mm)	Kg
05249.18.30.013	9	970	36°	3000	Ra>80	170x70	0,5
05249.18.40.015	9	1020	36°	4000	Ra>80	170x70	0,5

JEWEL



Housing	Electrostatic coated steel sheet and aluminum heatsink
Reflector	Highly efficient vacuumed aluminum coated PC reflector and deglaring diffuser combined with thermoplastic reflector (UGR<17)
Light Source	MacAdam Step-3 high efficacy High Power LED with lifetime L80B50 > 50,000h
Driver	Constant current output, Pf>0.90
Supply Voltage	220-240V/50-60Hz
Ambient Temperature	-20C°/+40C°
Options	Dali 3 hour emergency lighting kit

Color Options

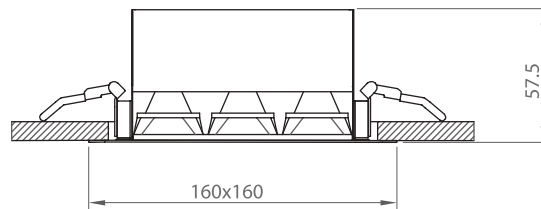
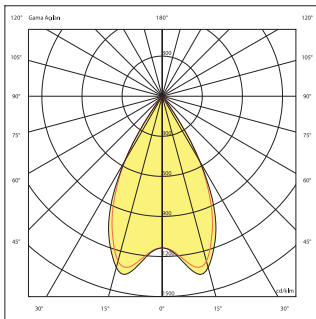

Order Code	W	Lm	Beam Angle	CCT	CRI	Cut-out (mm)	Kg
05243.14.30.030	32	3040	50°	3000	Ra>80	150x150	1,0
05243.14.40.031	31	3200	50°	4000	Ra>80	150x150	1,0

JEVEL MINI

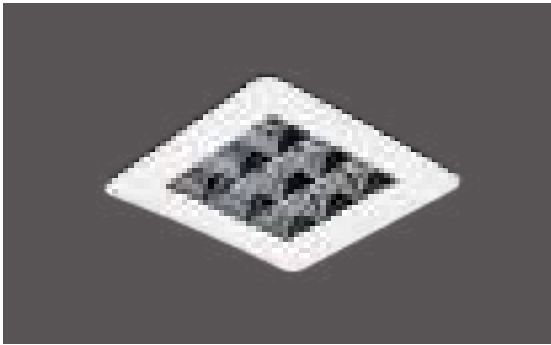

Housing	Electrostatic coated steel sheet and aluminum heatsink
Reflector	Highly efficient vacuumed aluminum coated PC reflector and deglaring diffuser combined with thermoplastic reflector (UGR<17)
Light Source	MacAdam Step-3 high efficacy High Power LED with lifetime L80B50 > 50,000h
Driver	Constant current output, Pf>0.90
Supply Voltage	220-240V/50-60Hz
Ambient Temperature	-20C°/+40C°
Options	Dali 3 hour emergency lighting kit

Color Options

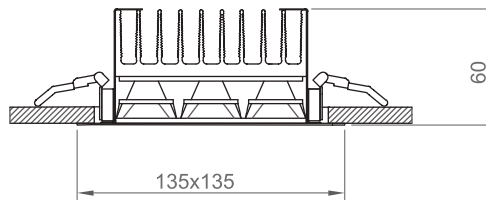
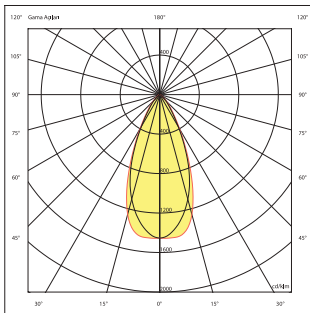
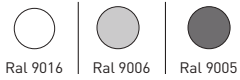

Order Code	W	Lm	Beam Angle	CCT	CRI	Cut-out (mm)	Kg
05245.18.30.021	20	1740	50°	3000	Ra>80	120X120	0,8
05245.18.40.022	20	1830	50 °	4000	Ra>80	120X120	0,8

TETRAD 085

For 85x85 Louvre Suspended Ceilings



Housing	Electrostatic coated steel sheet
Light Source	LED lamp with GU type lampholder
Driver	Constant current output, Pf>0.90
Supply Voltage	220-240V/50-60Hz
Ambient Temperature	-20C°/+40C°

Color Options

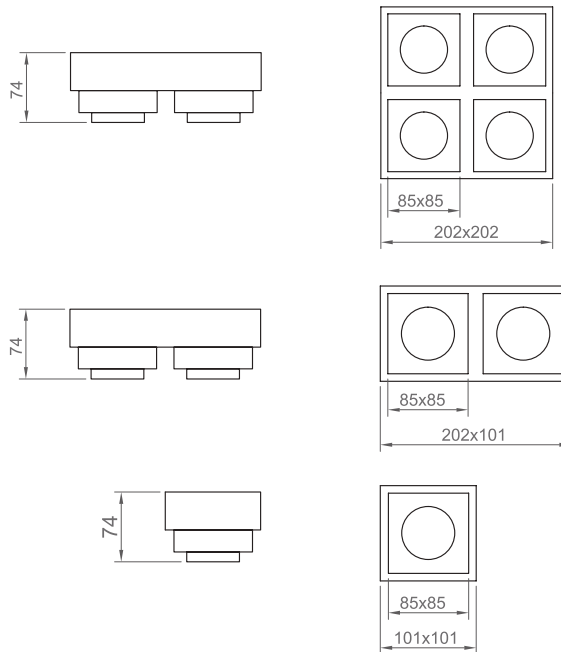
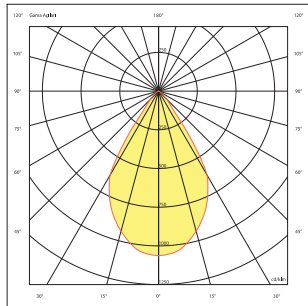
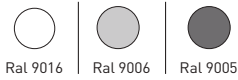

Order Code	W	Lm	Beam Angle	CCT	CRI	Cut-out (mm)	Kg
52018.160.001	4x4,5	4x355	36°	3000	Ra>80	4x85	0,9
52018.260.001	2x4,5	2x355	36°	3000	Ra>80	2x85	0,4
52018.460.001	1x4,5	1x355	36°	3000	Ra>80	1x85	0,2

For more updated information, please visit our website. www.ikizlerlighting.com

Lamp information is obtained from the manufacturer. Lamp's characteristics are subjected to change. Please contact us for detailed information.



TETRAD 060

60x60 Petek asma tavanlar için



Housing	Electrostatic coated steel sheet
Light Source	High efficacy Mid Power LED with lifetime L80B50 > 50,000h
Driver	Constant current output, Pf>0.90
Supply Voltage	220-240V/50-60Hz
Ambient Temperature	-20C°/+40C°

Color Options

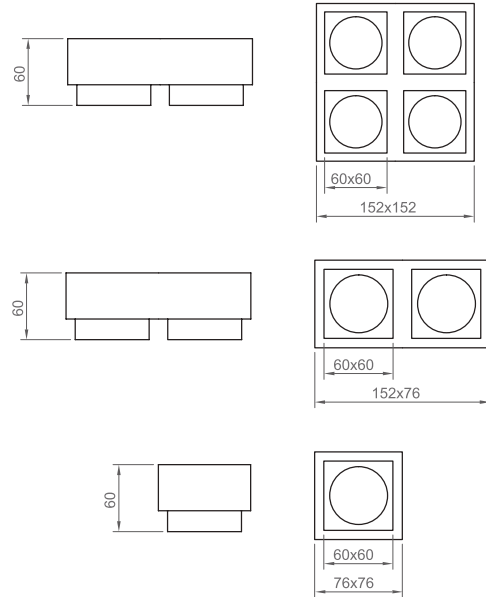
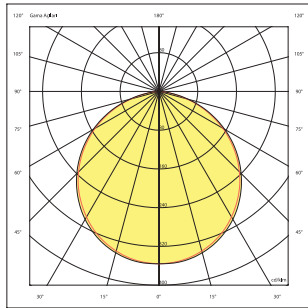
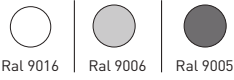

Order Code	W	Lm	CCT	CRI	Cut-out (mm)	Kg
05348.22.30.010	14	1000	3000	Ra>80	4x60	0,5
05348.22.30.005	7	500	3000	Ra>80	2x60	0,3
05348.22.30.002	3,5	250	3000	Ra>80	1x60	0,2
05348.22.40.010	14	1000	3000	Ra>80	4x60	0,5
05348.22.40.005	7	500	3000	Ra>80	2x60	0,3
05348.22.40.002	3,5	250	3000	Ra>80	1x60	0,2



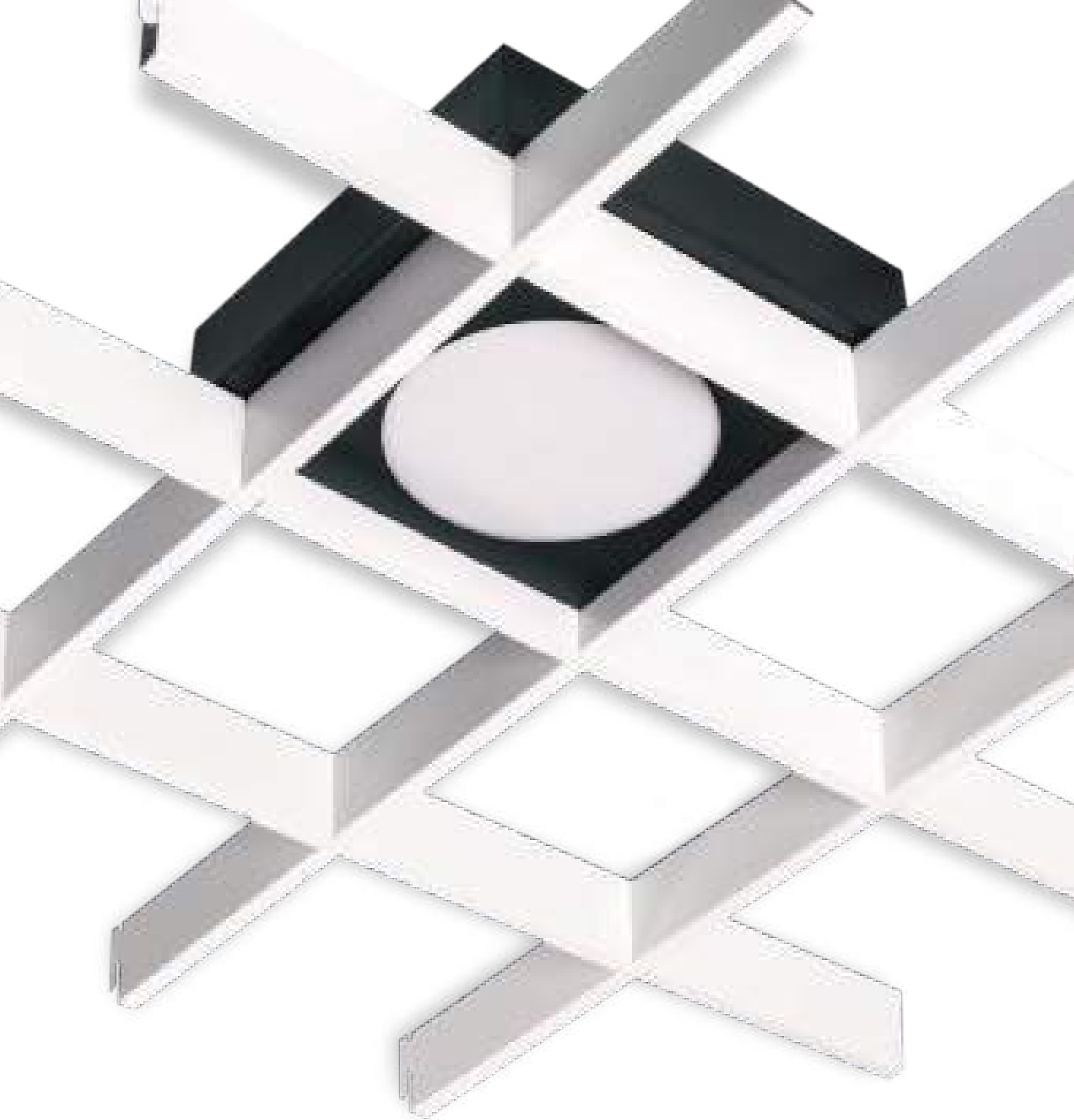

For 140x140 Louvre Suspended Ceilings **TETRAD 140**



Housing	Electrostatic coated steel sheet
Optics	Highly transmissive opal diffuser
Light Source	High efficacy Mid Power LED with lifetime L80B50 > 50,000h
Driver	Constant current output, Pf>0.90
Supply Voltage	220-240V/50-60Hz
Ambient Temperature	-20C°/+40C°
Options	Dali 3 hour emergency lighting kit

Color Options

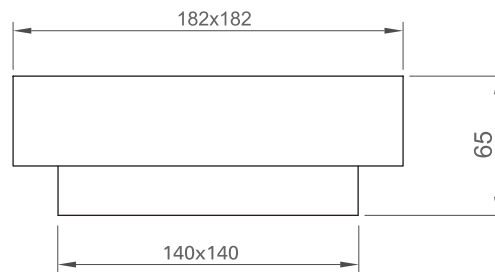
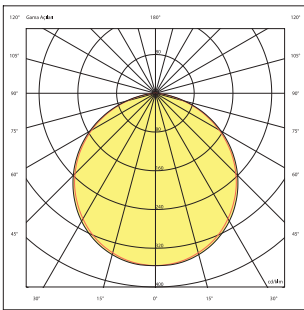
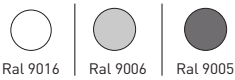

Order Code	W	Lm	CCT	CRI	Cut-out (mm)	Kg
05347.22.30.011	10	1100	3000	Ra>80	142x142	0.8
05347.22.40.013	10	1300	4000	Ra>80	142x142	0.8

MODUS-T



Housing	Extruded aluminum profile with electrostatic coating
Reflector	Glossary anodized aluminum reflector
Light Source	High efficacy COB LED with lifetime L80B50 > 50,000h
Driver	Constant current output, Pf>0.90
Supply Voltage	220-240V/50-60Hz
Ambient Temperature	-20C°/+40C°

Color Options

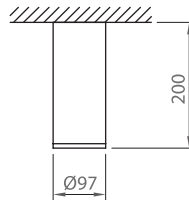
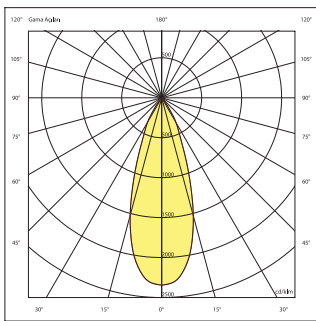
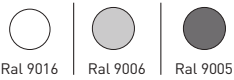

Order Code	W	Lm	Beam Angle	CCT	CRI	Kg
05648.97.30.013	14	1560	36°	3000	Ra>80	0,8
05648.97.30.018	19	2110	36°	3000	Ra>80	0,9
05648.97.40.014	14	1640	36°	4000	Ra>80	0,8
05648.97.40.019	19	2220	36°	4000	Ra>80	0,9

MODUS-S



Housing	Extruded aluminum profile with electrostatic coating
Reflector	Glossary anodized aluminum reflector
Light Source	High efficacy COB LED with lifetime L80B50 > 50,000h
Driver	Constant current output, Pf>0.90
Supply Voltage	220-240V/50-60Hz
Ambient Temperature	-20C°/+40C°

Color Options

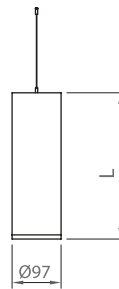
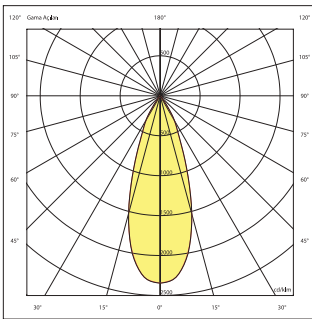
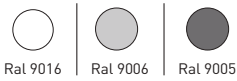

Order Code	W	Lm	Beam Angle	CCT	CRI	L	Kg
05648.97.30.018	14	1560	36°	3000	Ra>80	241	1,6
05648.97.30.027	19	2110	36°	3000	Ra>80	400	1,6
05648.97.40.019	14	1640	36°	3000	Ra>80	241	1,6
05648.97.40.028	19	2220	36°	4000	Ra>80	400	1,6

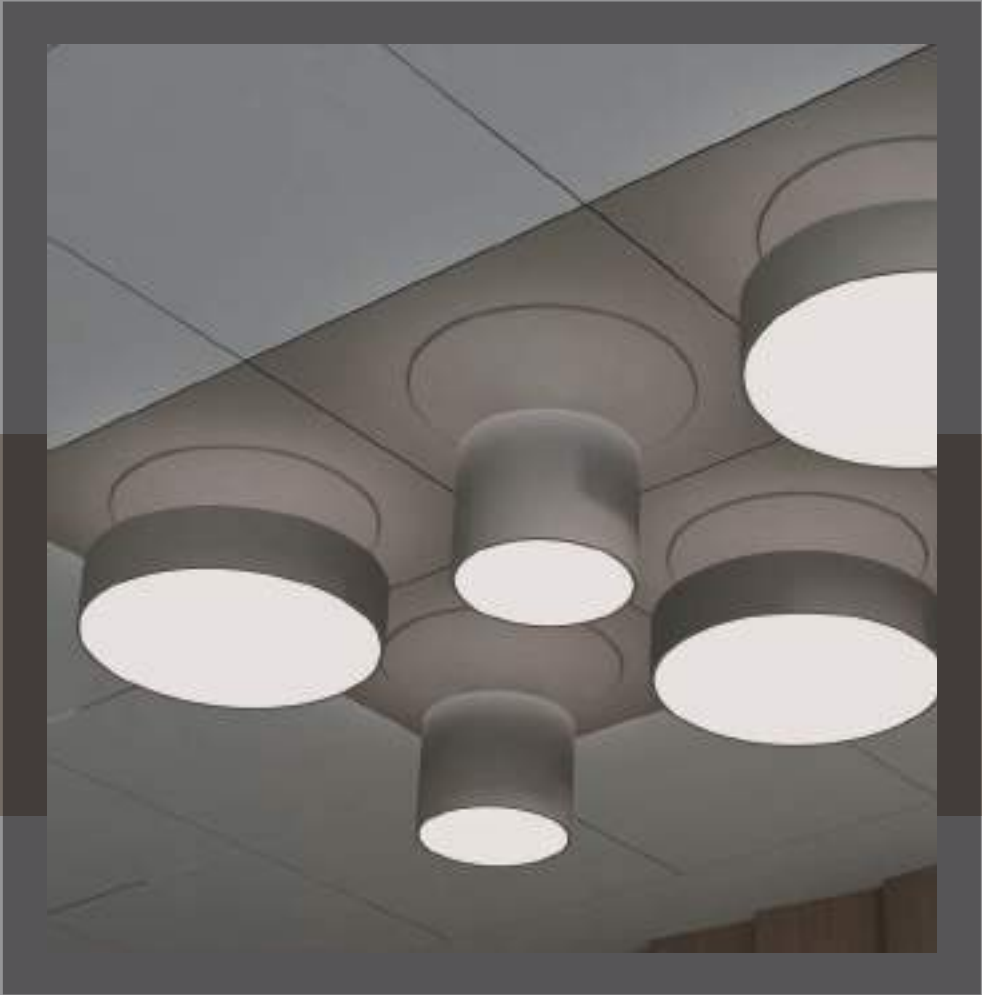

5 | RECESSED LIGHTING

DUET SHORT



Color Options

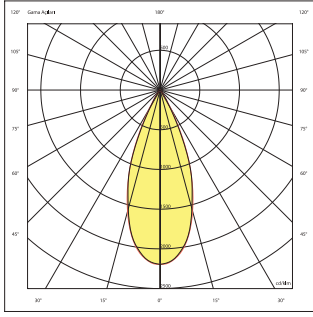

Housing	Electrostatic coated steel sheet, spot: aluminum profile
Diffuser	Endirek Diffuser, Highly transmissive opal diffuser
Reflector	Highly efficient vacuumed aluminum coated PC reflector and deglaring diffuser combined with thermoplastic reflector (UGR<16)
Light Source	High efficacy Mid Power LED with lifetime L80B50 > 50,000h
Driver	Constant current output, Pf>0.90
Supply Voltage	220-240V/50-60Hz
Ambient Temperature	-20C°/+40C°
Options	Dali 3 hour emergency lighting kit

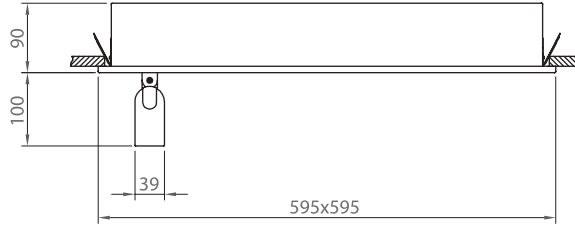

Tavan Tipi-Montaj Ölçüsü

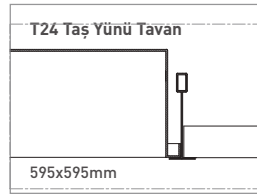

Order Code	W	Lm	Beam Angle	CCT	CRI	Kg
02128.66.30.029	50	3970	48°	3000	Ra>80	5,5
02128.66.40.030	50	4180	48°	4000	Ra>80	5,5

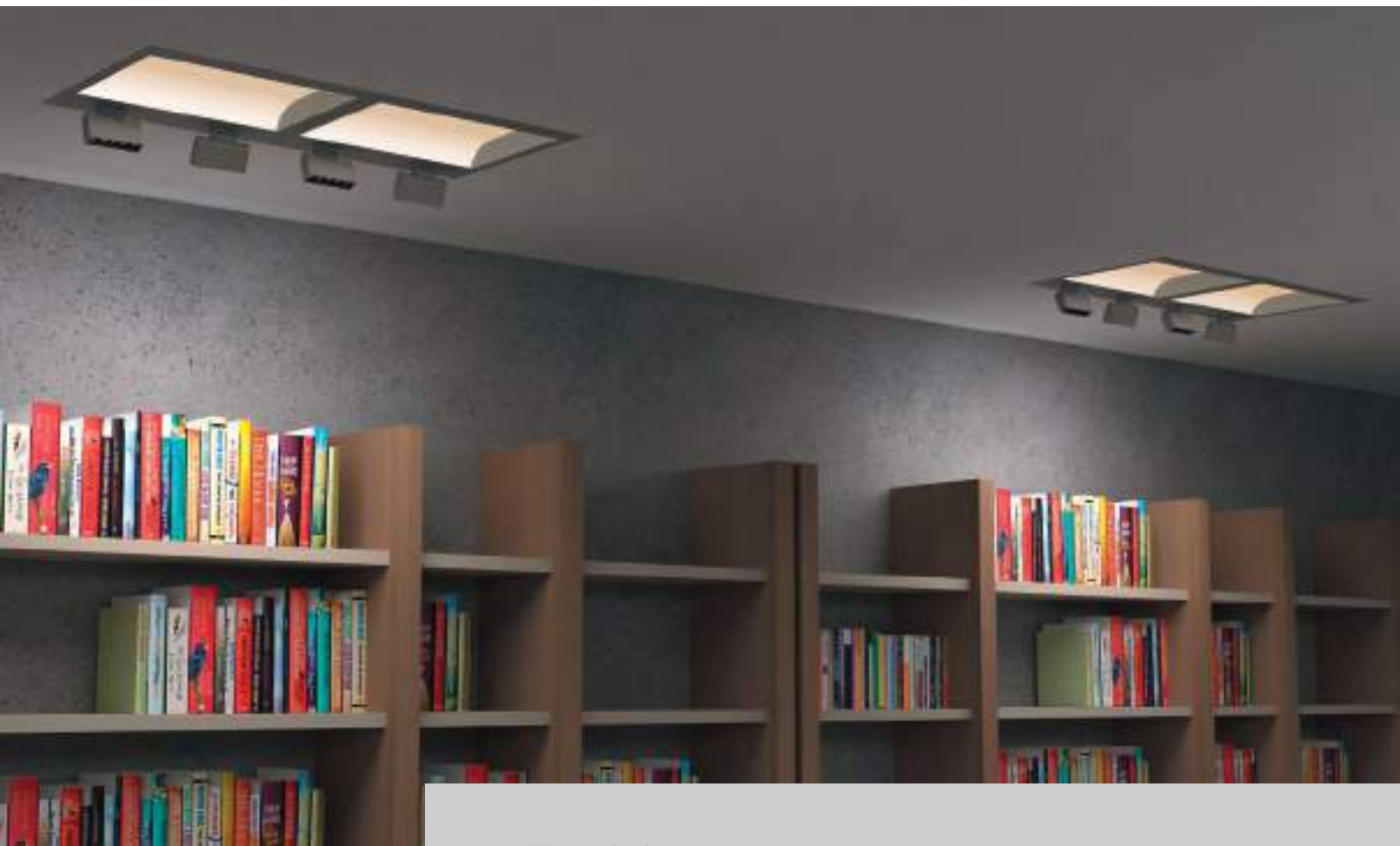

DUET is a 60x60 recessed ceiling fixture designed for suspended ceilings gridded or not, supplying both spot light and general light. In offices, you may want to use different products serving for different functions, spreading them on the ceiling that causes visual crowd unintentionally. DUET reduces this caotic view of ceilings, using these two functions in the same body, which can be lit at the same time or gradually switched as desired.

The curved translucent acrylic surface used as reflector provides smooth, undisturbing indirect lighting, arranging the general illumination. Direct lighting offers two linear-spot light options, 16cm and 48cm, which have slim forms thanks to LED light sources. These are adjustable in direction, so are used as exhibiton lighting for paintings, posters, sculptures and as library lighting. Detachability makes them adaptable to different scenarios and renewable. They can also be used individually on tracks, offering a wide variety of use.

Design: Ece Yalın Design Studio

DUET LONG



Color Options

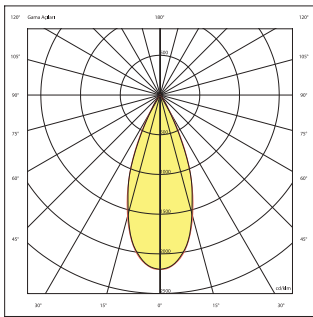
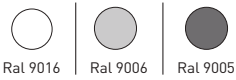

Housing	Electrostatic coated steel sheet, spot: aluminum profile
Diffuser	Endirek Diffuser, Highly transmissive opal diffuser
Reflector	Highly efficient vacuumed aluminum coated PC reflector and deglaring diffuser combined with thermoplastic reflector (UGR<16)
Light Source	High efficacy Mid Power LED with lifetime L80B50 > 50,000h
Driver	Constant current output, Pf>0.90
Supply Voltage	220-240V/50-60Hz
Ambient Temperature	-20C°/+40C°
Options	Dali 3 hour emergency lighting kit

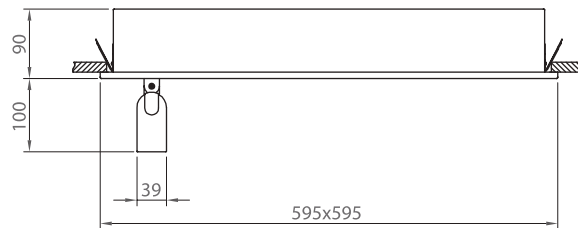

Ceiling Type-Cut-out

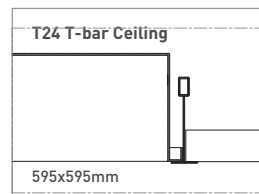

Order Code	W	Lm	Beam Angle	CCT	CRI	Kg
02128.66.30.044	54	4400	48°	3000	Ra>80	5,5
02128.66.40.046	54	4640	48°	4000	Ra>80	5,5

NOON MAXI



Color Options



Housing	Aluminum profile with electrostatic coating
Diffuser	Highly transmissive opal diffuser
Light Source	High efficacy Mid Power LED with lifetime L80B50 > 50,000h
Driver	Constant current output, Pf>0.90
Supply Voltage	220-240V/50-60Hz
Ambient Temperature	-20C°/+50C°
Options	Dali 3 hour emergency lighting kit

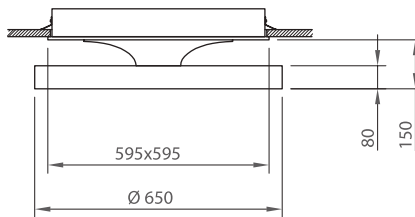
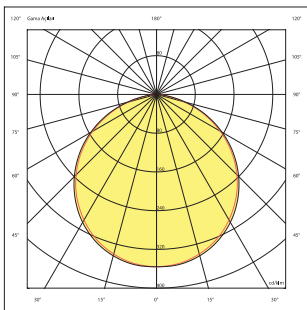

Ceiling Type-Cut-out

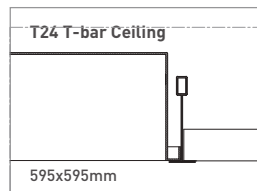

Order Code	W	Lm	CCT	CRI	Kg
02137.60.30.045	46	4150	3000	Ra>80	7,1
02137.60.40.046	46	4370	4000	Ra>80	7,1



NOON is designed to provide a distinctive decorative appearance without compromising the quality of illumination, with respect to the existing conventional recessed lighting fixtures mounted on standard 60x60 gridded ceilings which are still widely used in office spaces.

Design: Ece Yalın Design Studio



NOON MIDI



Housing	Aluminum profile with electrostatic coating
Diffuser	Highly transmissive opal diffuser
Light Source	High efficacy Mid Power LED with lifetime L80B50 > 50,000h
Driver	Constant current output, Pf>0.90
Supply Voltage	220-240V/50-60Hz
Ambient Temperature	-20C°/+50C°
Options	Dali 3 hour emergency lighting kit

Color Options

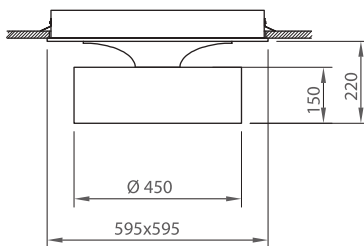
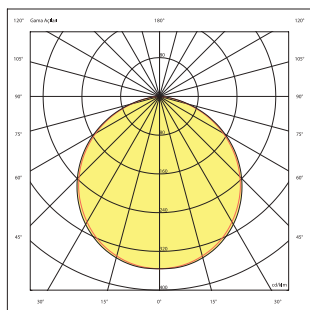

Ceiling Type-Cut-out

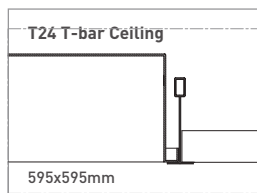

Order Code	W	Lm	CCT	CRI	Kg
02137.45.30.034	35	3158	3000	Ra>80	5,0
02137.45.40.035	35	3325	4000	Ra>80	5,0



Housing	Aluminum profile with electrostatic coating
Diffuser	Highly transmissive opal diffuser
Light Source	High efficacy Mid Power LED with lifetime L80B50 > 50,000h
Driver	Constant current output, Pf>0.90
Supply Voltage	220-240V/50-60Hz
Ambient Temperature	-20C°/+50C°
Options	Dali 3 hour emergency lighting kit

Color Options

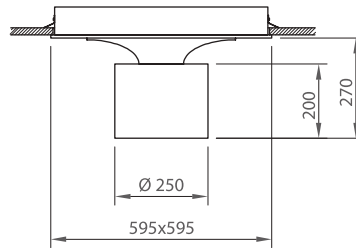
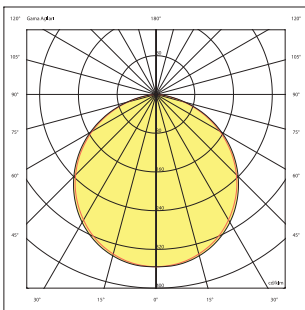
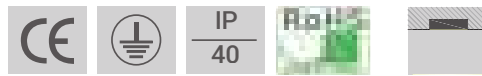
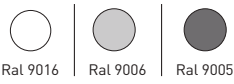

Ceiling Type-Cut-out

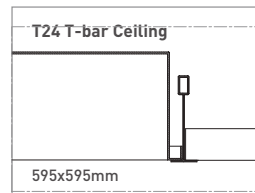

Order Code	W	Lm	CCT	CRI	Kg
02137.25.30.017	18	1625	3000	Ra>80	3,0
02137.25.40.018	18	1710	4000	Ra>80	3,0

CORVUS-G 1200



Housing	Aluminum profile with electrostatic coating
Diffuser	Highly transmissive opal diffuser
Light Source	High efficacy Mid Power LED with lifetime L80B50 > 50,000h
Driver	Constant current output, Pf>0.90
Supply Voltage	220-240V/50-60Hz
Ambient Temperature	-20C°/+40C°
Options	Dali 3 hour emergency lighting kit

Color Options

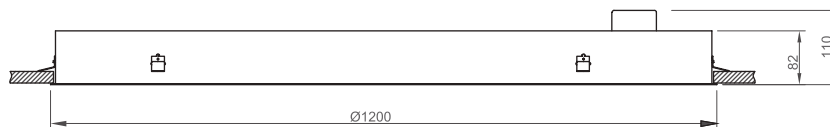
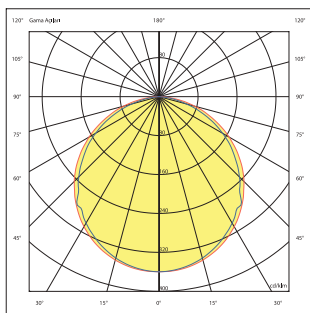

Order Code	W	Lm	CCT	CRI	Cut-out (mm)	Kg
02130.12.30.092	96	8665	3000	Ra>80	Ø1190	6,8
02130.12.40.097	96	9120	4000	Ra>80	Ø1190	6,8

900 CORVUS-G

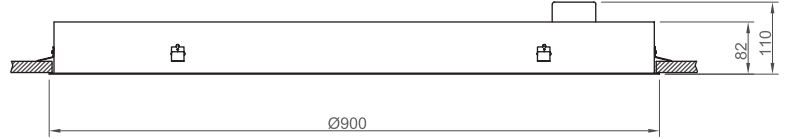

Color Options

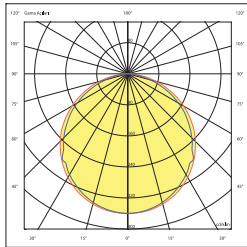

Order Code	W	Lm	CCT	CRI	Cut-out (mm)	Kg
02130.90.30.065	69	6220	3000	Ra>80	Ø890	5,6
02130.90.40.069	69	6550	4000	Ra>80	Ø890	5,6

600 CORVUS-G

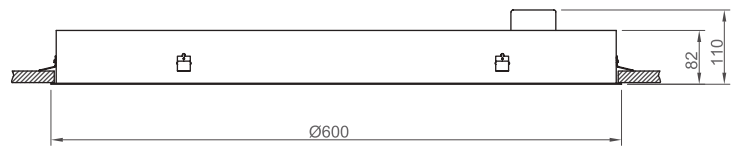

Color Options

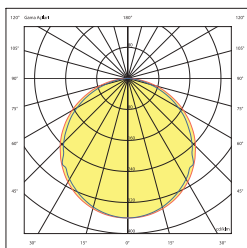
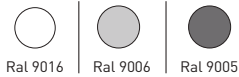

Order Code	W	Lm	CCT	CRI	Cut-out (mm)	Kg
02130.60.30.045	47	4240	3000	Ra>80	Ø590	3,4
02130.60.40.047	47	4460	4000	Ra>80	Ø590	3,4

500 CORVUS-G

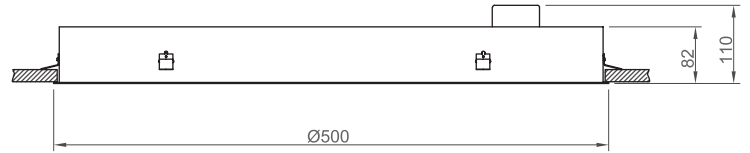

Color Options

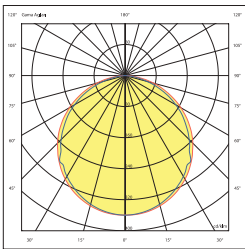
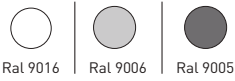

Order Code	W	Lm	CCT	CRI	Cut-out (mm)	Kg
02130.50.30.036	38	3430	3680	Ra>80	Ø490	3,2
02130.50.40.039	38	3610	4890	Ra>80	Ø590	3,2

380 CORVUS-G

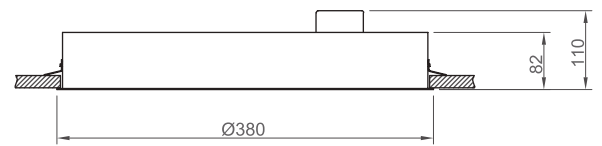

Color Options

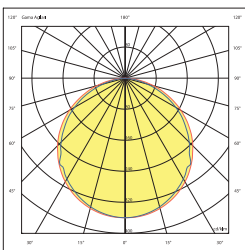
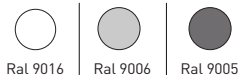

Order Code	W	Lm	CCT	CRI	Cut-out (mm)	Kg
02130.38.30.021	20	1800	3000	Ra>80	Ø370	2,1
02130.38.40.022	20	1900	4000	Ra>80	Ø370	2,1

ROLLING

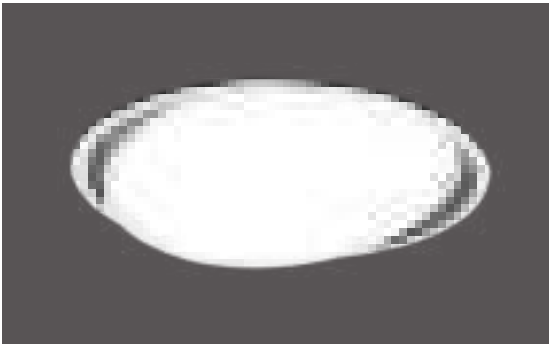

Color Options

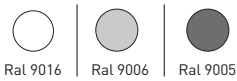

Housing	Aluminum profile with electrostatic coating
Diffuser	Highly transmissive opal diffuser
Light Source	High efficacy Mid Power LED with lifetime L80B50 > 50,000h
Driver	Constant current output, Pf>0.90
Supply Voltage	220-240V/50-60Hz
Ambient Temperature	-20C°/+40C°
Options	Dali 3 hour emergency lighting kit

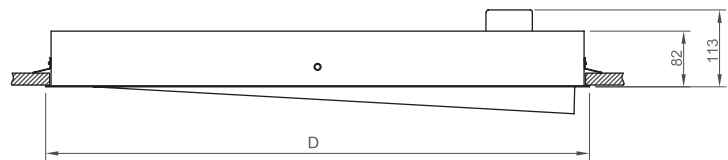
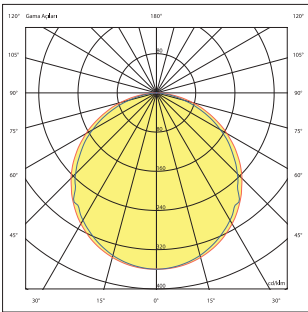

Order Code	W	Lm	CCT	CRI	D	Cut-out (mm)	Kg
03170.38.30.023	23	2075	3000	Ra>80	Ø380	Ø370	4,6
03170.38.40.024	23	2185	4000	Ra>80	Ø380	Ø370	4,6
03170.60.30.042	41	3700	3000	Ra>80	Ø600	Ø590	7,2
03170.60.40.043	41	3900	4000	Ra>80	Ø600	Ø590	7,2

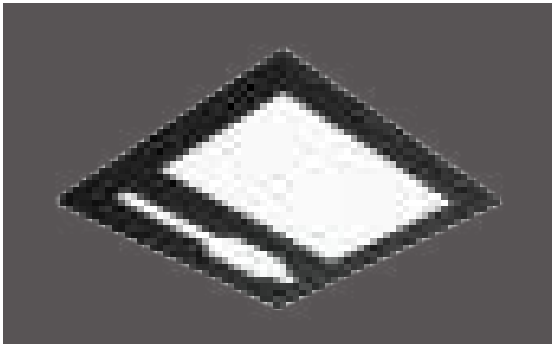

Housing	Electrostatic coated steel sheet
Diffuser	Highly transmissive opal diffuser
Light Source	High efficacy Mid Power LED with lifetime L80B50 > 50,000h
Driver	Constant current output, Pf>0.90
Supply Voltage	220-240V/50-60Hz
Ambient Temperature	-20C°/+40C°
Options	Dali 3 hour emergency lighting kit

Color Options

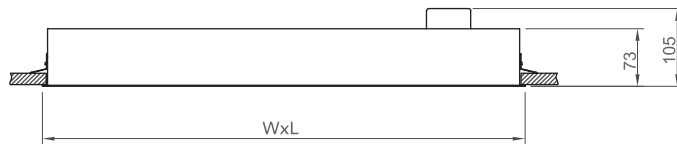
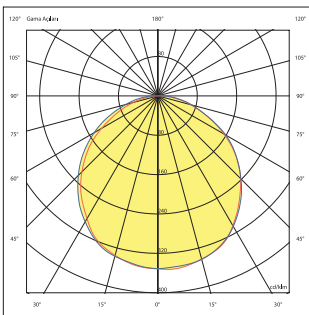

Ceiling Type-Cut-out

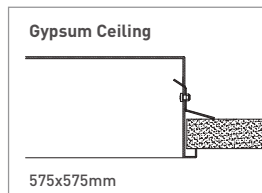

02121.66..

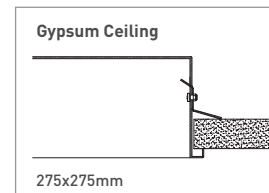

02120.33..

Order Code	W	Lm	CCT	CRI	W x L (mm)	Kg
02121.66.30.032	31	3200	3000	Ra>80	595x595	4,1
02120.33.30.008	9	800	3000	Ra>80	295x295	2,1
02121.66.40.033	31	3300	4000	Ra>80	595x595	4,1
02120.33.40.009	9	850	4000	Ra>80	295x295	2,1

DARKLINE

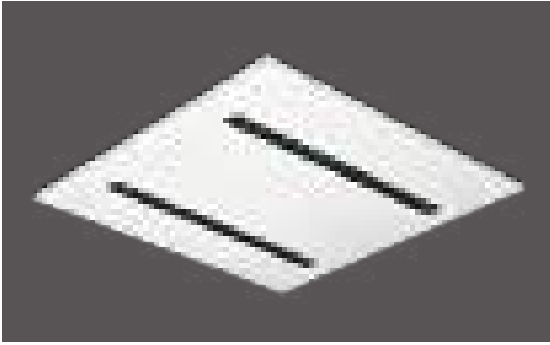

Housing	Electrostatic coated steel sheet
Reflector	Highly efficient, aluminum coated, vacuumed PC reflector and deglaring (UGR<17)
Light Source	High efficacy Mid Power LED with lifetime L80B50 > 50,000h
Driver	Constant current output, Pf>0.90
Supply Voltage	220-240V/50-60Hz
Ambient Temperature	-20C°/+40C°
Options	Dali 3 hour emergency lighting kit

Color Options

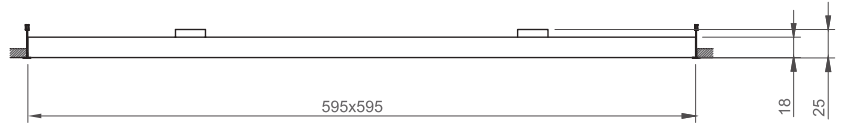
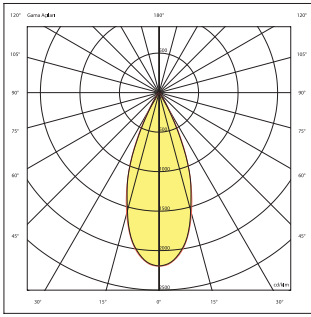
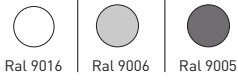

Ceiling Type-Cut-out

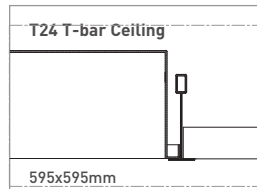

Order Code	W	Lm	Açı	CCT	CRI	Kg
02173.66.30.029	27	2950	80°	3000	Ra>80	3,9
02173.66.40.030	27	3080	80°	4000	Ra>80	3,9

SILVERLINE



Housing	Electrostatic coated steel sheet
Reflector	Highly efficient, aluminum coated, vacuumed PC reflector and deglaring (UGR<17)
Light Source	High efficacy Mid Power LED with lifetime L80B50 > 50,000h
Driver	Constant current output, Pf>0.90
Supply Voltage	220-240V/50-60Hz
Ambient Temperature	-20C°/+40C°
Options	Dali 3 hour emergency lighting kit

Color Options

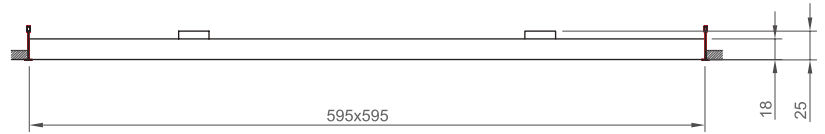
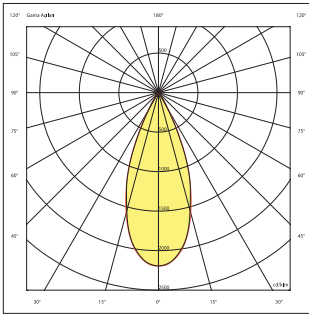
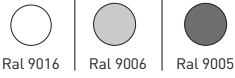

Ceiling Type-Cut-out

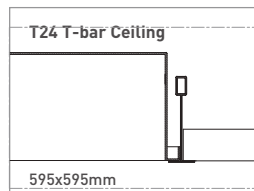

Order Code	W	Lm	Açı	CCT	CRI	Kg
02174.66.30.029	27	2950	36°	3000	Ra>80	3,9
02174.66.40.030	27	3080	36°	4000	Ra>80	3,9

GLARE-G

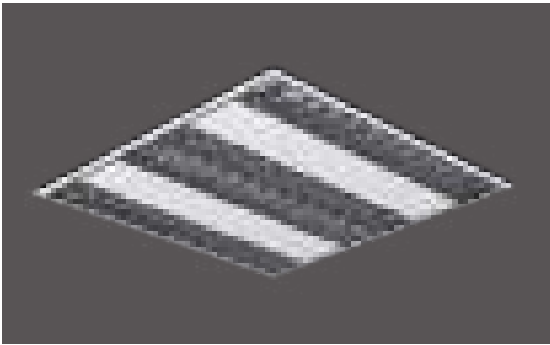

Housing	Electrostatic coated steel sheet
Optics	Highly transmissive opal diffuser
Reflector	Deglaring, glossary aluminum reflector (UGR>19)
Light Source	High efficacy Mid Power LED with lifetime L80B50 > 50,000h
Driver	Constant current output, Pf>0.90
Supply Voltage	220-240V/50-60Hz
Ambient Temperature	-20C°/+40C°
Options	Dali 3 hour emergency lighting kit

Color Options

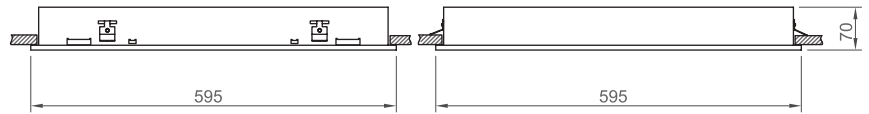
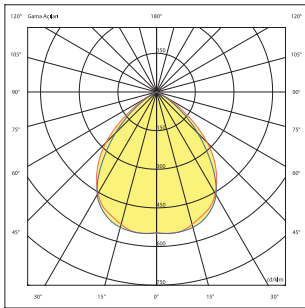

Ceiling Type-Cut-out

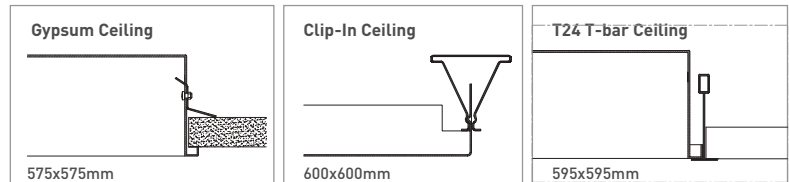

Order Code	W	Lm	CCT	CRI	Kg
02500.66.30.028	35	3135	3000	Ra>80	4,5
02500.66.40.030	35	3300	4000	Ra>80	4,5

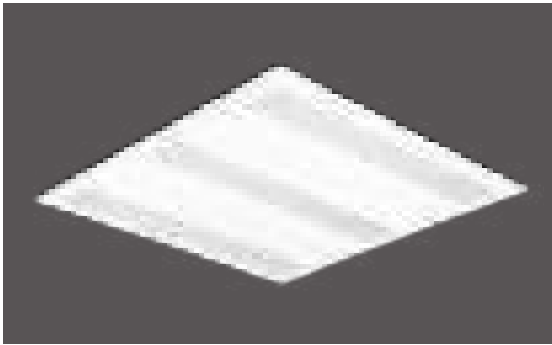

Housing	Electrostatic coated steel sheet
Optics	Highly transmissive opal diffuser
Light Source	High efficacy Mid Power LED with lifetime L80B50 > 50,000h
Driver	Constant current output, Pf>0.90
Supply Voltage	220-240V/50-60Hz
Ambient Temperature	-20C°/+40C°
Options	Dali 3 hour emergency lighting kit

Color Options

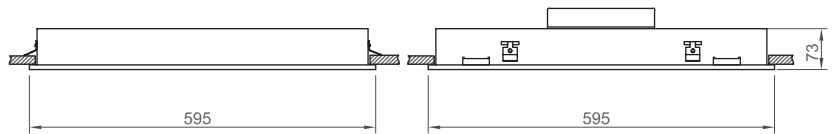
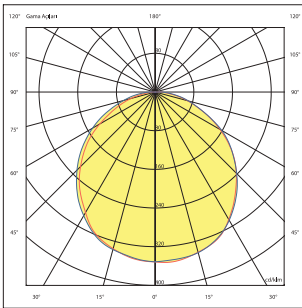
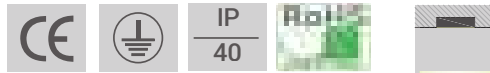
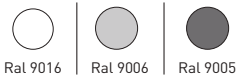

Ceiling Type-Cut-out

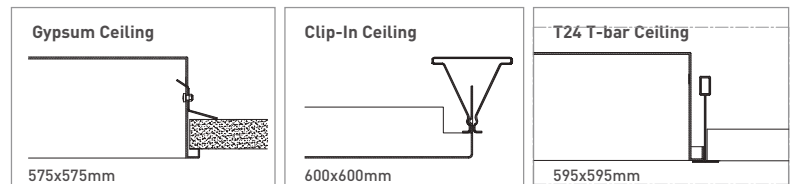

Order Code	W	Lm	CCT	CRI	Kg
02150.66.30.022	29	2300	3000	Ra>80	3,9
02150.66.30.031	41	3300	3000	Ra>80	3,9
02150.66.40.023	29	2450	4000	Ra>80	3,9
02150.66.40.032	41	3500	4000	Ra>80	3,9

DOME-G Direct Indirect Luminaire



Color Options



Housing	Electrostatic coated steel sheet
Diffuser	Electrostatic coated perforated steel reflector with electrostatic coated steel sheet on the back and opal diffuser
Light Source	High efficacy Mid Power LED with lifetime L80B50 > 50,000h
Driver	Constant current output, Pf>0.90
Supply Voltage	220-240V/50-60Hz
Ambient Temperature	-20C°/+40C°
Options	Dali 3 hour emergency lighting kit

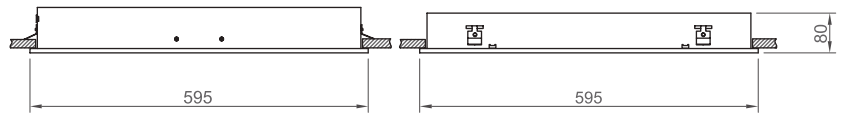
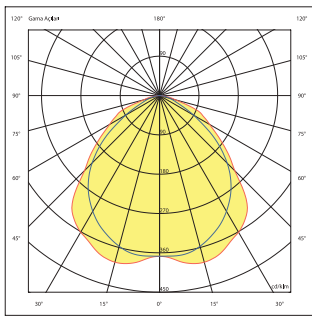

Ceiling Type-Cut-out

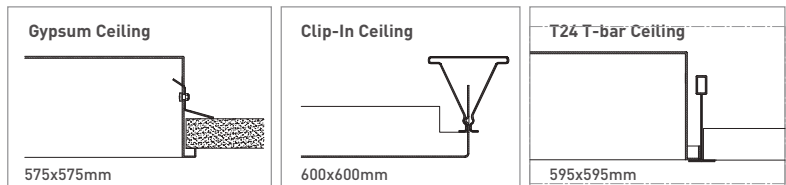

Order Code	W	Lm	CCT	CRI	Kg
02115.66.30.023	29	2320	3000	Ra>80	4,7
02115.66.30.031	41	3170	3000	Ra>80	4,7
02115.66.30.052	60	5280	3000	Ra>80	4,7
02115.66.40.024	29	2450	4000	Ra>80	4,7
02115.66.40.042	41	3360	4000	Ra>80	4,7
02115.66.30.041	60	5600	4000	Ra>80	4,7

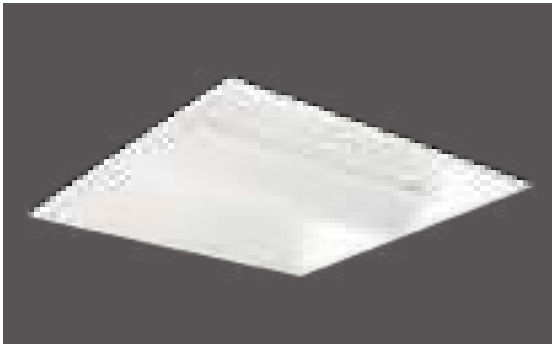

Housing	Electrostatic coated steel sheet
Diffuser	Electrostatic coated steel reflector with electrostatic coated steel sheet on the back
Light Source	High efficacy Mid Power LED with lifetime L80B50 > 50,000h
Driver	Constant current output, Pf>0.90
Supply Voltage	220-240V/50-60Hz
Ambient Temperature	-20C°/+40C°
Options	Dali 3 hour emergency lighting kit

Color Options

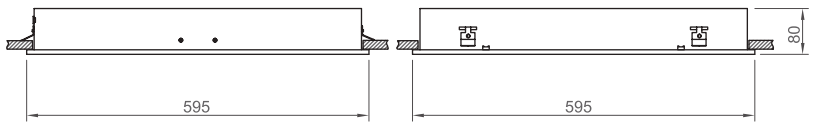
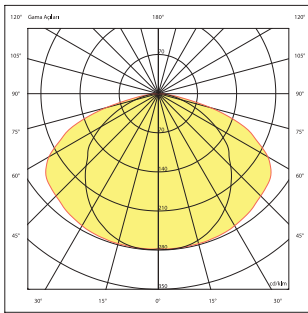
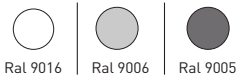

Ceiling Type-Cut-out

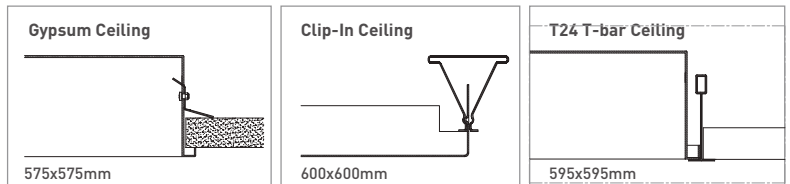

Order Code	W	Lm	CCT	CRI	Kg
02145.66.30.020	27	1700	3000	Ra>80	4.2
02145.66.30.024	40	2730	3000	Ra>80	4.2
02145.66.40.019	27	1800	4000	Ra>80	4.2
02145.66.40.029	40	2890	4000	Ra>80	4.2

BALIO-G



Housing	Electrostatic coated steel sheet
Diffuser	Highly transmissive opal diffuser
Light Source	High efficacy Mid Power LED with lifetime L80B50 > 50,000h
Driver	Constant current output, Pf>0.90
Supply Voltage	220-240V/50-60Hz
Ambient Temperature	-20C°/+40C°
Options	Dali 3 hour emergency lighting kit

Color Options

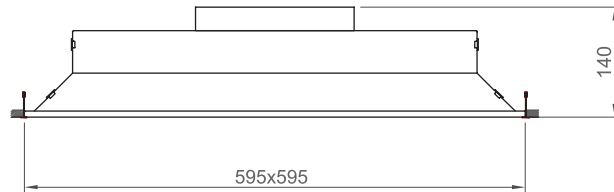
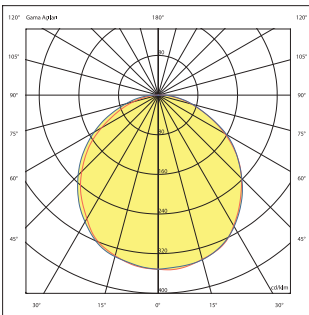

Ceiling Type-Cut-out

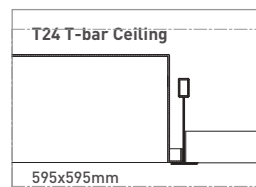

Order Code	W	Lm	CCT	CRI	Kg
02112.66.30.032	28	3200	3000	Ra>80	3,2
02112.66.30.036	33	3600	3000	Ra>80	3,2
02112.66.40.033	28	3350	4000	Ra>80	3,2
02112.66.40.037	33	3700	4000	Ra>80	3,2



Color Options



Housing	Electrostatic coated steel sheet
Optics	Highly transmissive opal diffuser
Light Source	High efficacy Mid Power LED with lifetime L80B50 > 50,000h
Driver	Constant current output, Pf>0.90
Supply Voltage	220-240V/50-60Hz
Ambient Temperature	-20C°/+40C°
Options	Dali 3 hour emergency lighting kit

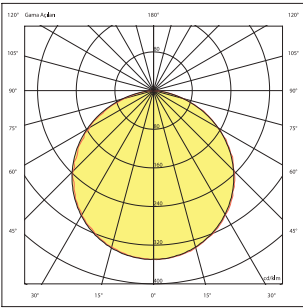

Ceiling Type-Cut-out

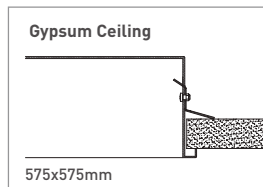

Order Code	W	Lm	CCT	CRI	Kg
02119.66.30.032	33	3200	3000	Ra>80	4,1
02119.66.40.034	33	3350	4000	Ra>80	4,1

BRAID

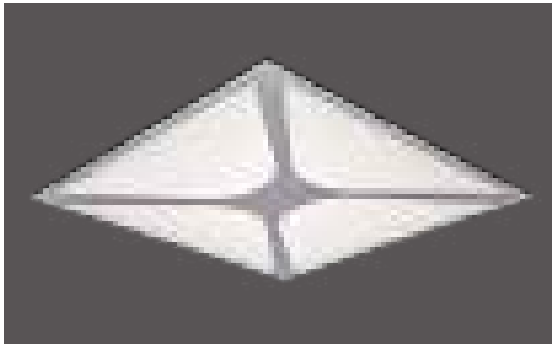

Housing	Electrostatic coated steel sheet
Diffuser	Highly transmissive opal diffuser
Light Source	High efficacy Mid Power LED with lifetime L80B50 > 50,000h
Driver	Constant current output, Pf>0.90
Supply Voltage	220-240V/50-60Hz
Ambient Temperature	-20C°/+40C°
Options	Dali 3 hour emergency lighting kit

Color Options

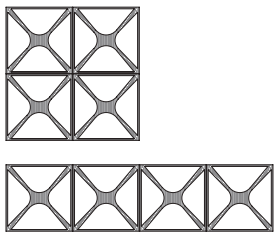
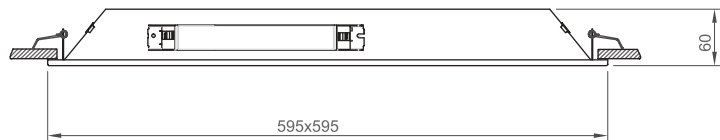
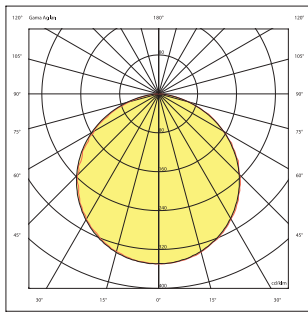
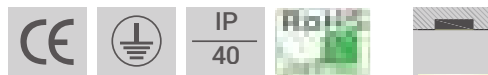
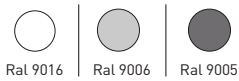

Ceiling Type-Cut-out

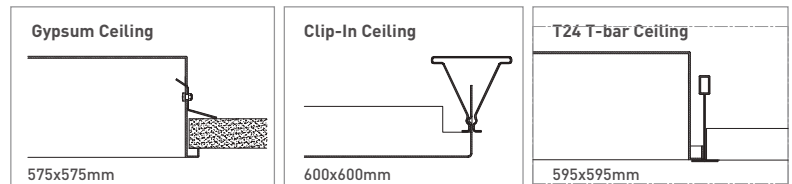

Order Code	W	Lm	CCT	CRI	Kg
02176.66.30.029	28	2930	3000	Ra>80	4,1
02176.66.40.031	28	3100	4000	Ra>80	4,1

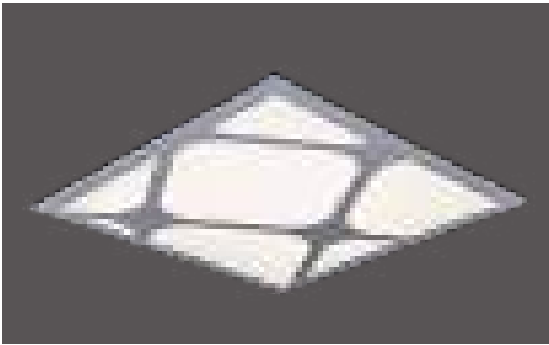

Housing	Electrostatic coated steel sheet
Optics	Highly transmissive opal diffuser
Light Source	High efficacy Mid Power LED with lifetime L80B50 > 50,000h
Driver	Constant current output, Pf>0.90
Supply Voltage	220-240V/50-60Hz
Ambient Temperature	-20C°/+40C°
Options	Dali 3 hour emergency lighting kit

Color Options

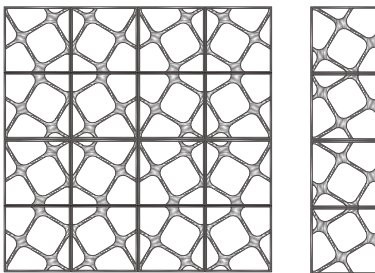
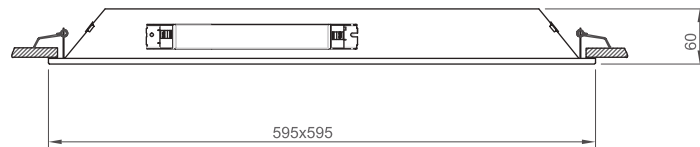
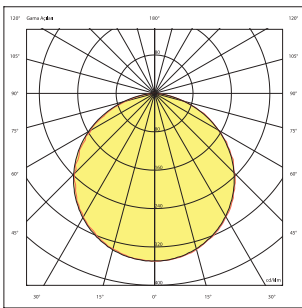

Ceiling Type-Cut-out

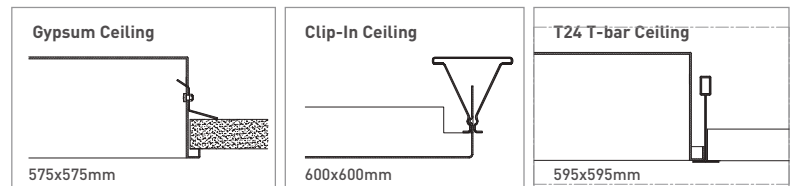

Order Code	W	Lm	CCT	CRI	Kg
02118.66.30.028	28	2930	3000	Ra>80	4,1
02119.66.40.034	28	3100	4000	Ra>80	4,1

ASTRAL



Color Options



Housing	Electrostatic coated steel sheet
Diffuser	Highly transmissive opal diffuser
Light Source	High efficacy Mid Power LED with lifetime L80B50 > 50,000h
Driver	Constant current output, Pf>0.90
Supply Voltage	220-240V/50-60Hz
Ambient Temperature	-20C°/+40C°
Options	Dali 3 hour emergency lighting kit

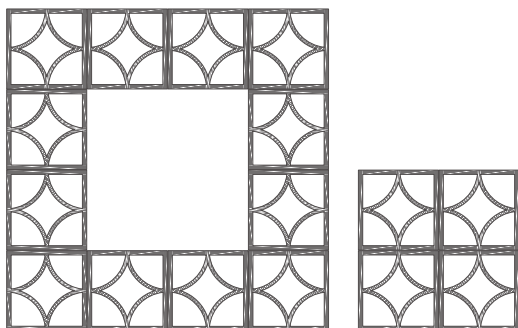
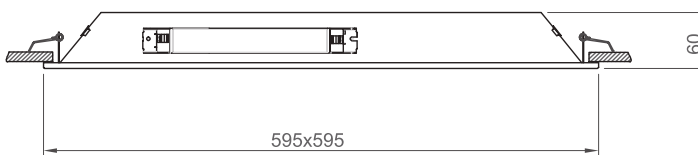
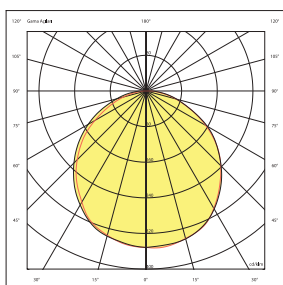
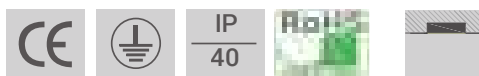

Ceiling Type-Cut-out

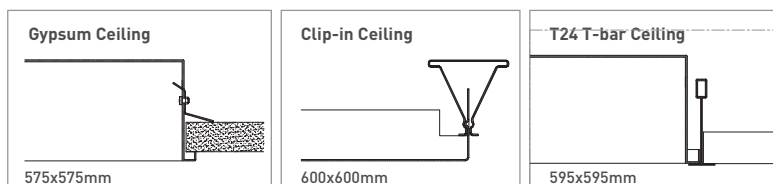

Order Code	W	Lm	CCT	CRI	Kg
02169.66.30.030	28	2930	3000	Ra>80	3,0
02169.66.40.031	28	3100	4000	Ra>80	3,0

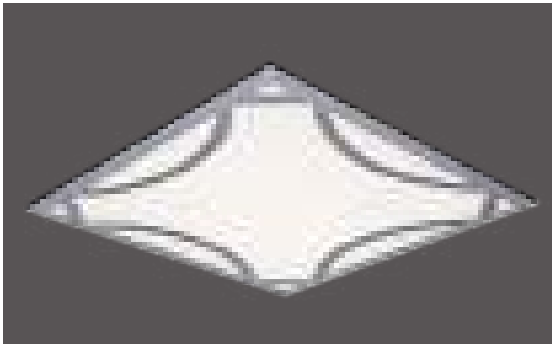

Housing	Electrostatic coated steel sheet
Diffuser	Highly transmissive opal diffuser
Light Source	High efficacy Mid Power LED with lifetime L80B50 > 50,000h
Driver	Constant current output, Pf>0.90
Supply Voltage	220-240V/50-60Hz
Ambient Temperature	-20C°/+40C°
Options	Dali 3 hour emergency lighting kit

Color Options

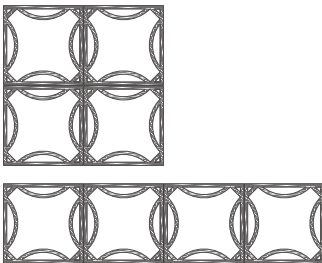
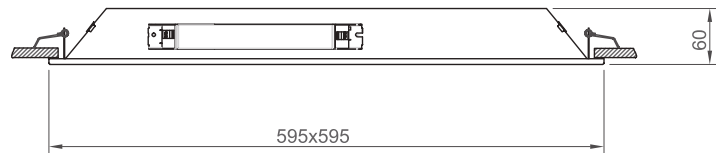
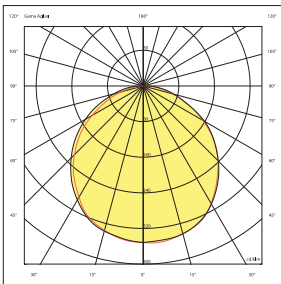
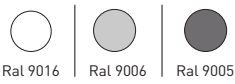

Ceiling Type-Cut-out

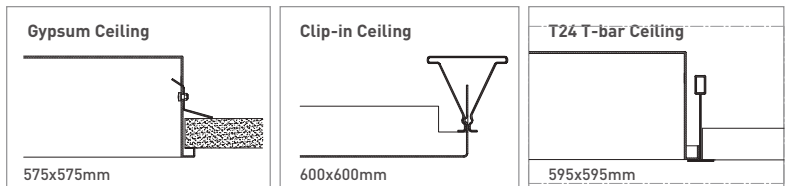

Order Code	W	Lm	CCT	CRI	Kg
02178.66.30.030	28	2930	3000	Ra>80	3,0
02178.66.40.031	28	3100	4000	Ra>80	3,0

RING

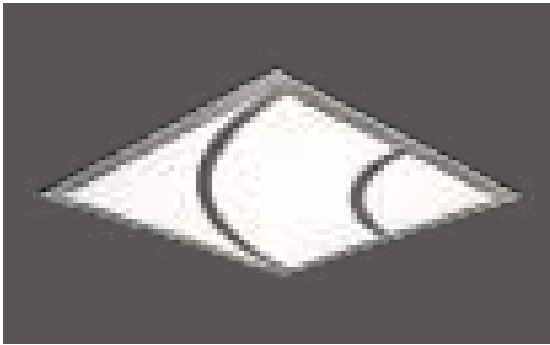

Color Options

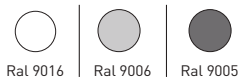

Housing	Electrostatic coated steel sheet
Diffuser	Highly transmissive opal diffuser
Light Source	High efficacy Mid Power LED with lifetime L80B50 > 50,000h
Driver	Constant current output, Pf>0.90
Supply Voltage	220-240V/50-60Hz
Ambient Temperature	-20C°/+40C°
Options	Dali 3 hour emergency lighting kit

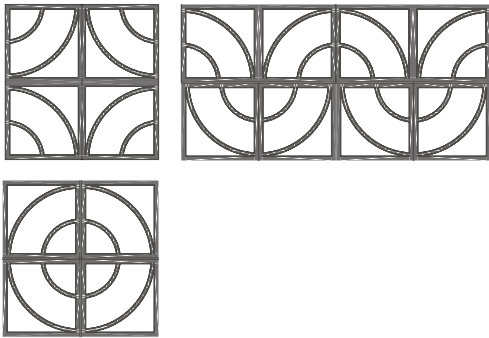
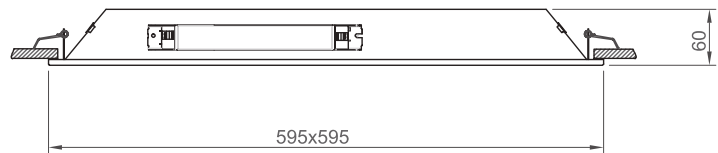
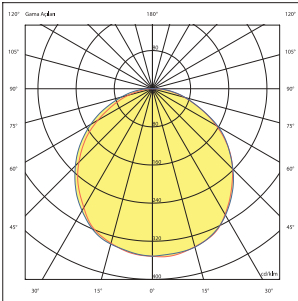

Ceiling Type-Cut-out

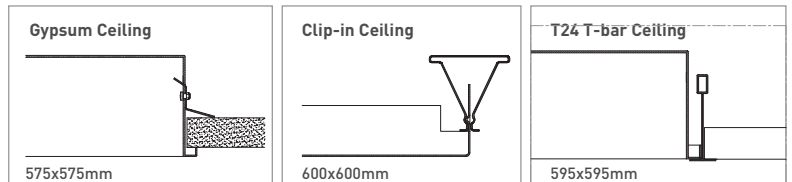

Order Code	W	Lm	CCT	CRI	Kg
02170.66.30.030	28	2930	3000	Ra>80	3,0
02170.66.40.031	28	3100	4000	Ra>80	3,0

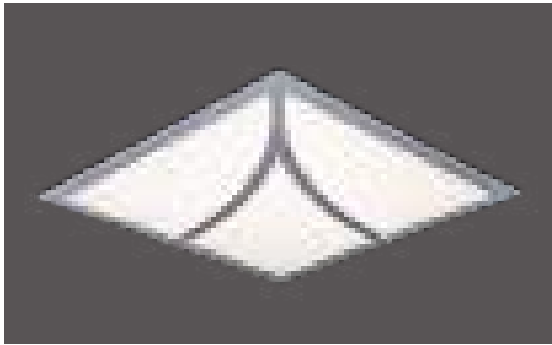

Housing	Electrostatic coated steel sheet
Diffuser	Highly transmissive opal diffuser
Light Source	High efficacy Mid Power LED with lifetime L80B50 > 50,000h
Driver	Constant current output, Pf>0.90
Supply Voltage	220-240V/50-60Hz
Ambient Temperature	-20C°/+40C°
Options	Dali 3 hour emergency lighting kit

Color Options

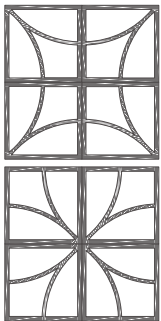
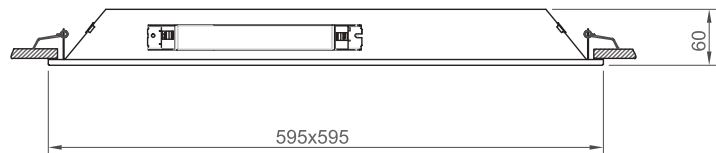
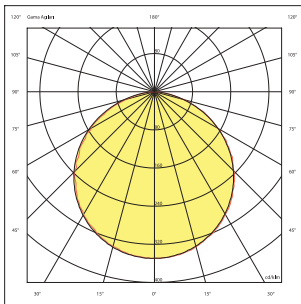

Ceiling Type-Cut-out

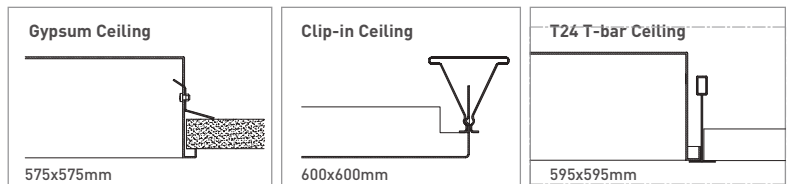

Order Code	W	Lm	CCT	CRI	Kg
02177.66.30.030	28	2930	3000	Ra>80	3,0
02177.66.40.031	28	3100	4000	Ra>80	3,0

TETR'S-G

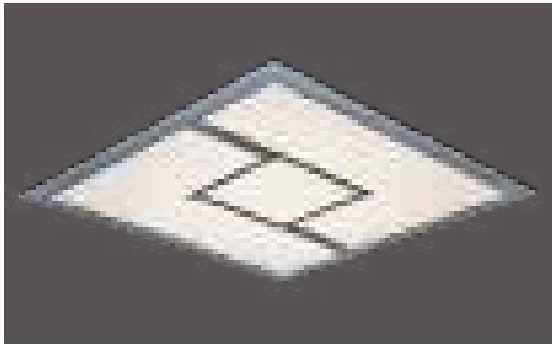

Housing	Electrostatic coated steel sheet
Diffuser	Highly transmissive opal diffuser
Light Source	High efficacy Mid Power LED with lifetime L80B50 > 50,000h
Driver	Constant current output, Pf>0.90
Supply Voltage	220-240V/50-60Hz
Ambient Temperature	-20C°/+40C°
Options	Dali 3 hour emergency lighting kit

Color Options

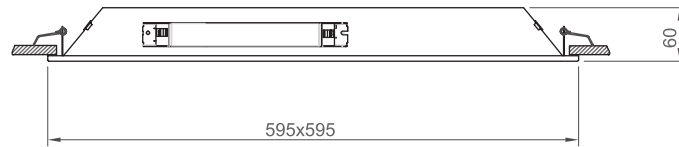
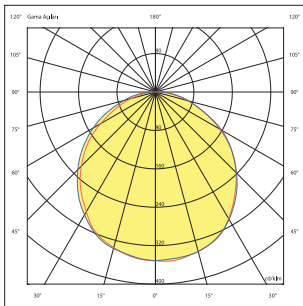

Ceiling Type-Cut-out

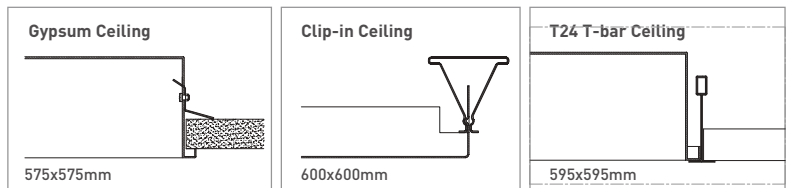

Order Code	W	Lm	CCT	CRI	Kg
02133.66.30.032	28	2930	3000	Ra>80	3,0
02133.66.40.033	28	3100	4000	Ra>80	3,0

ROUND

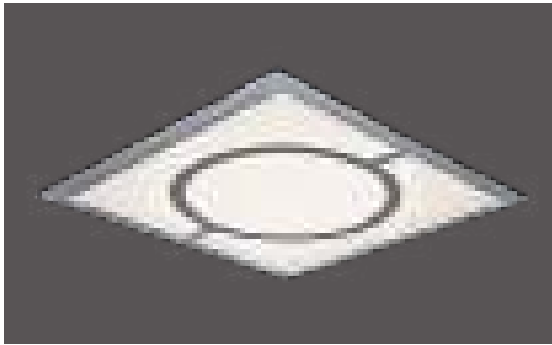

Housing	Electrostatic coated steel sheet
Diffuser	Highly transmissive opal diffuser
Light Source	High efficacy Mid Power LED with lifetime L80B50 > 50,000h
Driver	Constant current output, Pf>0.90
Supply Voltage	220-240V/50-60Hz
Ambient Temperature	-20C°/+40C°
Options	Dali 3 hour emergency lighting kit

Color Options

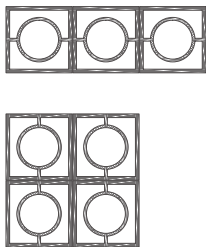
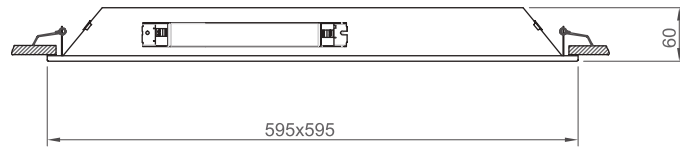
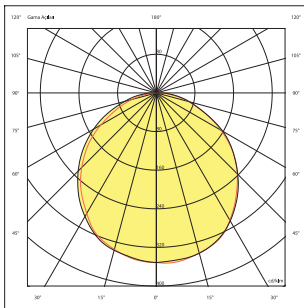
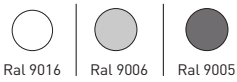

Ceiling Type-Cut-out

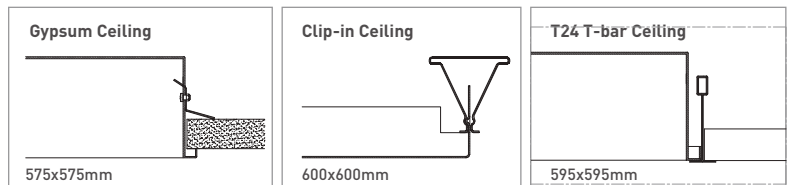

Order Code	W	Lm	CCT	CRI	Kg
02171.66.30.030	28	2930	3000	Ra>80	3,0
012171.66.40.031	28	3100	4000	Ra>80	3,0

FULLMOON



Housing	Electrostatic coated steel sheet
Diffuser	Highly transmissive opal diffuser
Light Source	High efficacy Mid Power LED with lifetime L80B50 > 50,000h
Driver	Constant current output, Pf>0.90
Supply Voltage	220-240V/50-60Hz
Ambient Temperature	-20C°/+40C°
Options	Dali 3 hour emergency lighting kit

Color Options

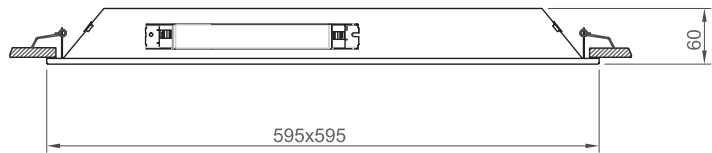
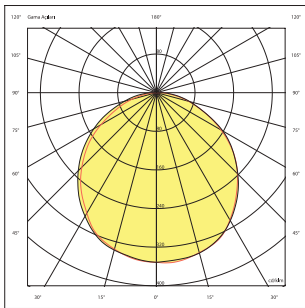
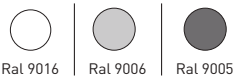

Ceiling Type-Cut-out

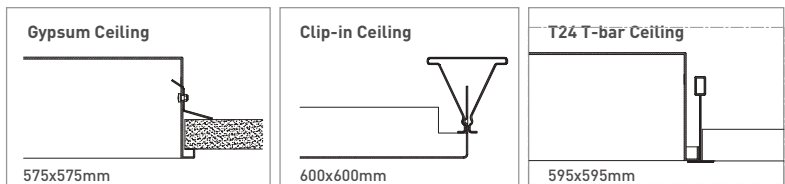

Order Code	W	Lm	CCT	CRI	Kg
02161.66.30.027	28	2700	3000	Ra>80	3,1
02161.66.40.028	28	2800	4000	Ra>80	3,1



Housing	Electrostatic coated steel sheet
Diffuser	Highly transmissive opal diffuser
Light Source	High efficacy Mid Power LED with lifetime L80B50 > 50,000h
Driver	Constant current output, Pf>0.90
Supply Voltage	220-240V/50-60Hz
Ambient Temperature	-20C°/+40C°
Options	Dali 3 hour emergency lighting kit

Color Options

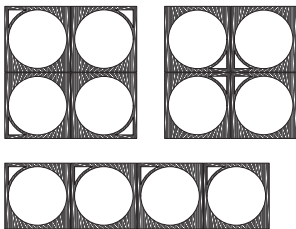
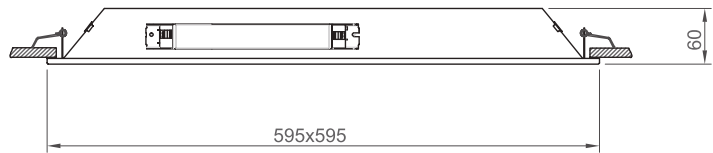
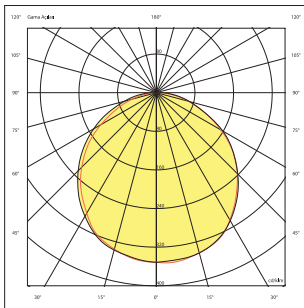
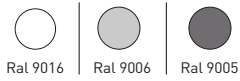

Ceiling Type-Cut-out

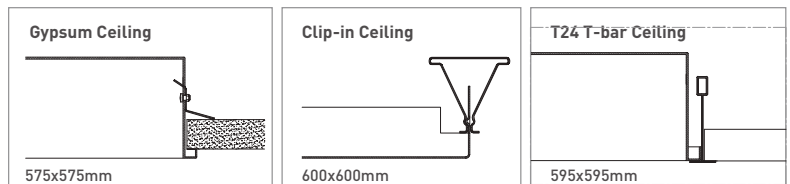

Order Code	W	Lm	CCT	CRI	Kg
02172.66.30.032	28	2700	3000	Ra>80	3.1
02172.66.40.033	28	2800	4000	Ra>80	3.1

LEAF

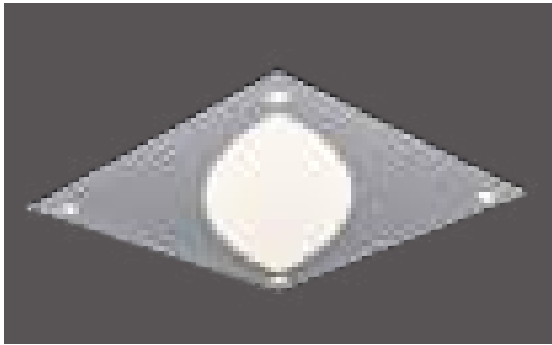

Housing	Electrostatic coated steel sheet
Diffuser	Highly transmissive opal diffuser
Light Source	High efficacy Mid Power LED with lifetime L80B50 > 50,000h
Driver	Constant current output, Pf>0.90
Supply Voltage	220-240V/50-60Hz
Ambient Temperature	-20C°/+40C°
Options	Dali 3 hour emergency lighting kit

Color Options

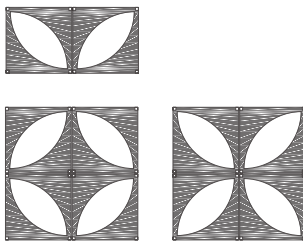
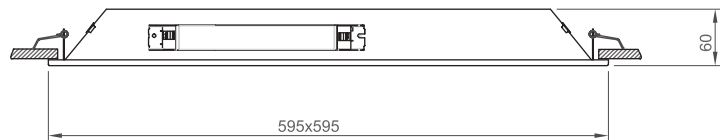
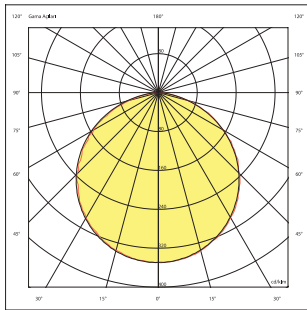

Ceiling Type-Cut-out

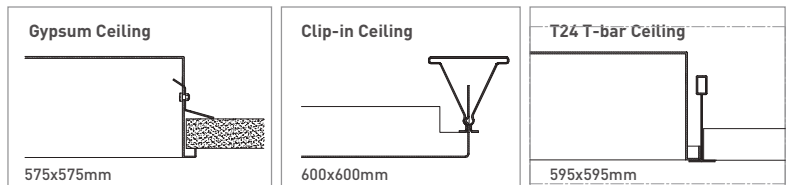

Order Code	W	Lm	CCT	CRI	Kg
02116.66.30.023	33	1820	3000	Ra>80	3,1
02116.66.40.025	33	1930	4000	Ra>80	3,1

GRUS SIGMA

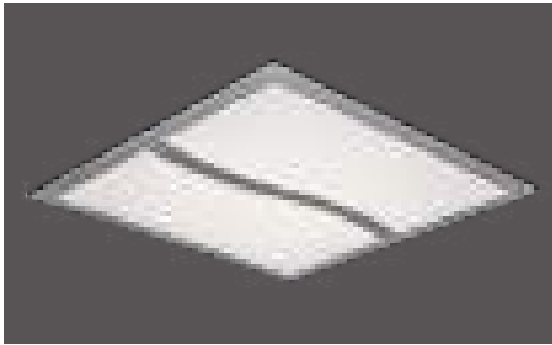

Housing	Electrostatic coated steel sheet
Diffuser	Highly transmissive opal diffuser
Light Source	High efficacy Mid Power LED with lifetime L80B50 > 50,000h
Driver	Constant current output, Pf>0.90
Supply Voltage	220-240V/50-60Hz
Ambient Temperature	-20C°/+40C°
Options	Dali 3 hour emergency lighting kit

Color Options

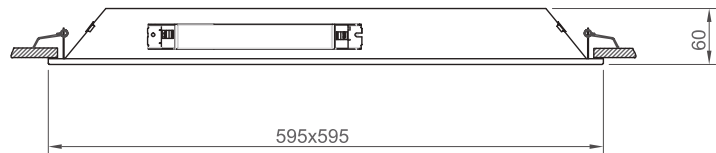
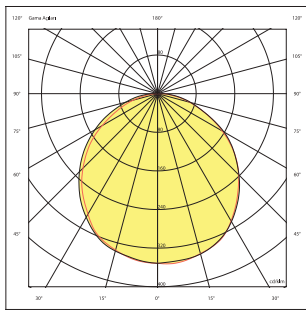

Ceiling Type-Cut-out

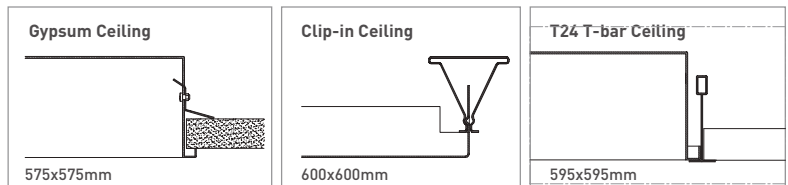

Order Code	W	Lm	CCT	CRI	Kg
02120.66.30.037	33	3450	3000	Ra>80	3,1
02120.66.40.038	33	3600	4000	Ra>80	3,1

FLAT-G 600 For T24 T-bar and Gypsum Ceiling



Color Options

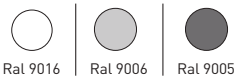

Housing	Electrostatic coated steel sheet
Diffuser	Highly transmissive opal diffuser
Light Source	High efficacy Mid Power LED with lifetime L80B50 > 50,000h
Driver	Constant current output, Pf>0.90
Supply Voltage	220-240V/50-60Hz
Ambient Temperature	-20C°/+40C°
Options	Dali 3 hour emergency lighting kit IP 44

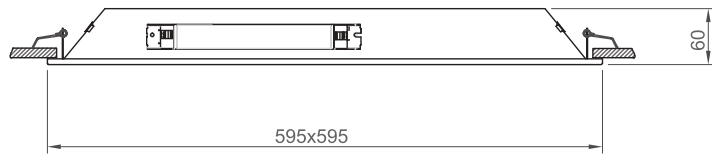
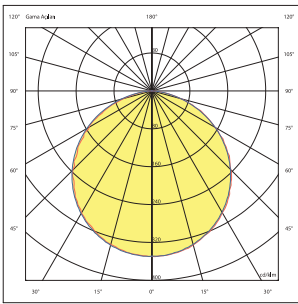

Ceiling Type-Cut-out

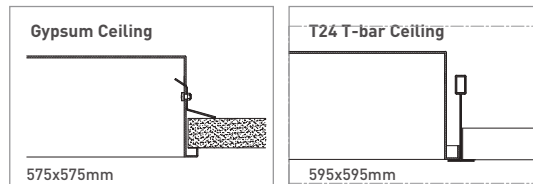

Order Code	W	Lm	CCT	CRI	Kg
02110.66.30.031	31	3250	3000	Ra>80	2,8
02110.66.30.036	33	3600	3000	Ra>80	2,8
02110.66.30.040	35	4000	3000	Ra>80	2,8
02110.66.40.032	31	3350	4000	Ra>80	2,8
02110.66.40.037	33	3700	4000	Ra>80	2,8
02110.66.40.041	35	4100	4000	Ra>80	2,8

1230 FLAT-G

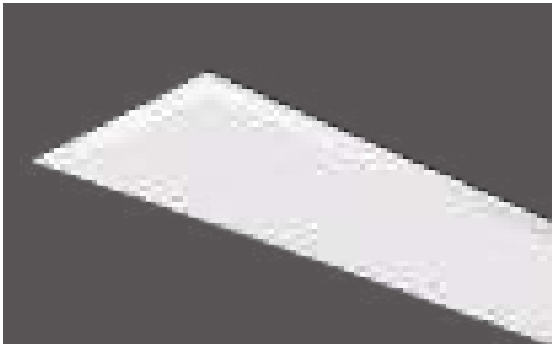

Housing	Electrostatic coated steel sheet
Diffuser	Highly transmissive opal diffuser
Light Source	High efficacy Mid Power LED with lifetime L80B50 > 50,000h
Driver	Constant current output, Pf>0.90
Supply Voltage	220-240V/50-60Hz
Ambient Temperature	-20C°/+40C°
Options	Dali 3 hour emergency lighting kit IP 44

Color Options

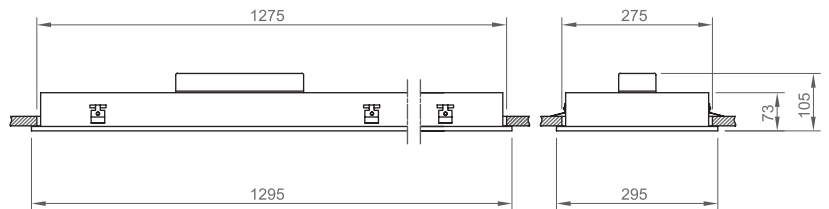
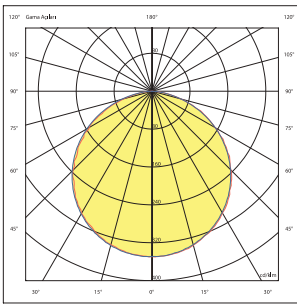
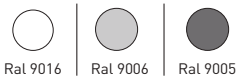

Ceiling Type-Cut-out

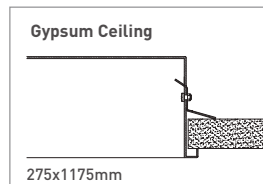

Order Code	W	Lm	CCT	CRI	Kg
02110.31.30.032	28	3200	3000	Ra>80	3,5
02110.31.40.033	28	3300	4000	Ra>80	3,5

FLAT-G 300



Color Options

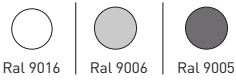

Housing	Electrostatic coated steel sheet
Diffuser	Highly transmissive opal diffuser
Light Source	High efficacy Mid Power LED with lifetime L80B50 > 50,000h
Driver	Constant current output, Pf>0.90
Supply Voltage	220-240V/50-60Hz
Ambient Temperature	-20C°/+40C°
Options	Dali 3 hour emergency lighting kit IP 44

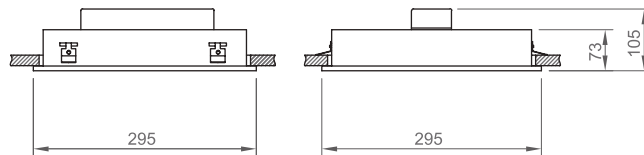
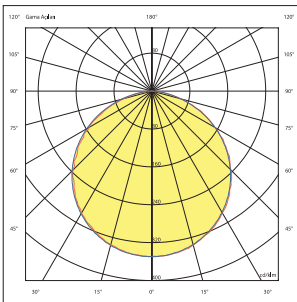

Ceiling Type-Cut-out

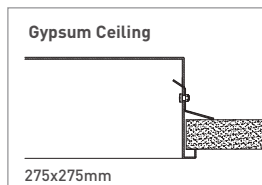

Order Code	W	Lm	CCT	CRI	Kg
02110.33.30.008	9	800	3000	Ra>80	1,4
02110.33.30.017	18	1700	3000	Ra>80	1,4
02110.33.40.009	9	900	4000	Ra>80	1,4
02110.33.40.018	18	1800	4000	Ra>80	1,4

FLAT-C 600 Clip-in



Housing	Electrostatic coated steel sheet
Diffuser	Highly transmissive opal diffuser
Light Source	High efficacy Mid Power LED with lifetime L80B50 > 50,000h
Driver	Constant current output, Pf>0.90
Supply Voltage	220-240V/50-60Hz
Ambient Temperature	-20C°/+40C°
Options	Dali 3 hour emergency lighting kit

Color Options

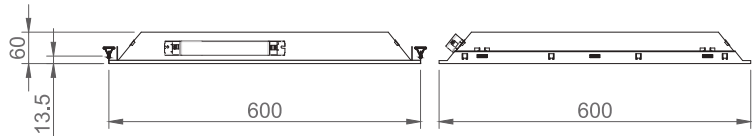
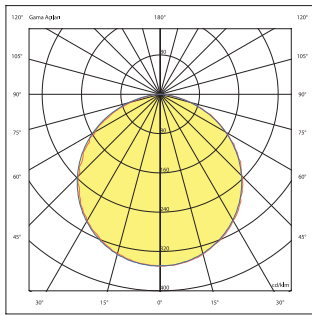

Ceiling Type-Cut-out

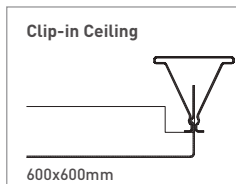

Order Code	W	Lm	CCT	CRI	Kg
02110.66.30.031.C	28	3100	3000	Ra>80	2,9
02110.66.30.036.C	33	3600	3000	Ra>80	2,9
02110.66.30.040.C	35	4000	3000	Ra>80	2,9
02110.66.40.032.C	28	3330	4000	Ra>80	2,9
02110.66.40.037.C	33	3700	4000	Ra>80	2,9
02110.66.40.041.C	35	4100	4000	Ra>80	2,9

Clip-in 300 **FLAT-C**



Housing	Electrostatic coated steel sheet
Diffuser	Highly transmissive opal diffuser
Light Source	High efficacy Mid Power LED with lifetime L80B50 > 50,000h
Driver	Constant current output, Pf>0.90
Supply Voltage	220-240V/50-60Hz
Ambient Temperature	-20C°/+40C°
Options	Dali 3 hour emergency lighting kit

Color Options

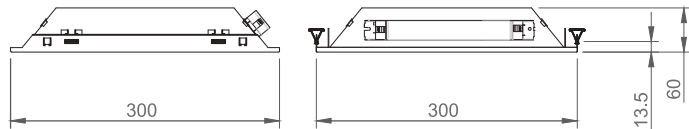
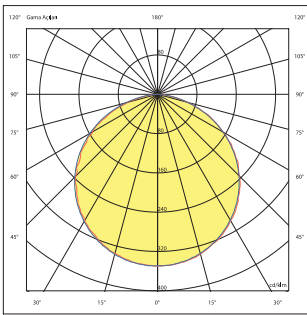
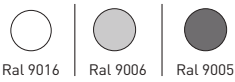

Ceiling Type-Cut-out

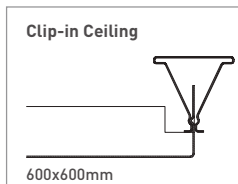

Order Code	W	Lm	CCT	CRI	Kg
02110.33.30.008.C	9	800	3000	Ra>80	1,5
02110.33.30.017.C	18	1700	3000	Ra>80	1,5
02110.33.40.009.C	9	900	4000	Ra>80	1,5
02110.33.40.017.C	18	1800	4000	Ra>80	1,5



6 | SURFACE LIGHTING

CORVUS-T 1200



Housing	Electrostatic coated aluminum profile
Diffuser	Highly transmissive opal diffuser
Light Source	High efficacy Mid Power LED with lifetime L80B50 > 50,000h
Driver	Constant current output, Pf>0.90
Supply Voltage	220-240V/50-60Hz
Ambient Temperature	-20C°/+40C°
Options	Dali 3 hour emergency lighting kit

Color Options

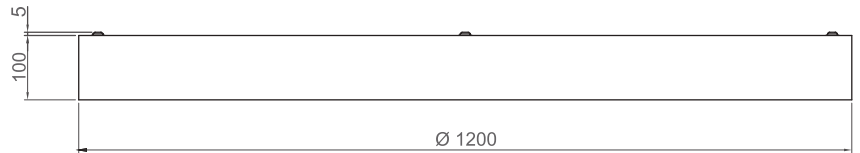
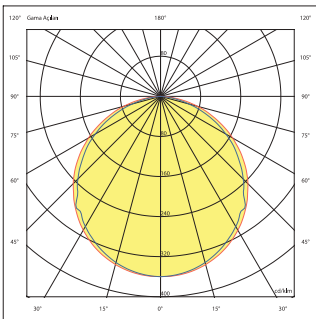

Order Code	W	Lm	CCT	CRI	Kg
03170.12.30.092	96	8665	3000	Ra>80	7,4
03170.12.40.097	96	9120	4000	Ra>80	7,4

900 CORVUS-T

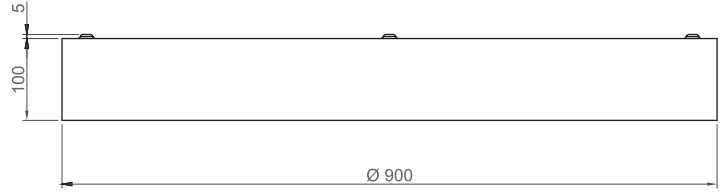

Color Options



Ral 9016

Ral 9006

Ral 9005

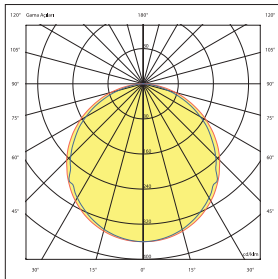

Order Code	W	Lm	CCT	CRI	Kg
03170.90.30.107	69	6220	3000	Ra>80	5,5
03170.90.40.111	69	6550	4000	Ra>80	5,5



600 CORVUS-T

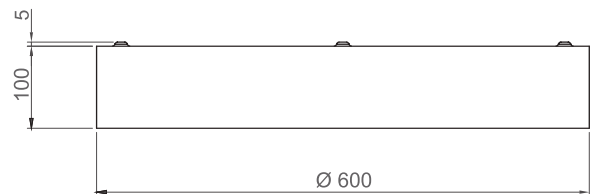

Color Options



Ral 9016

Ral 9006

Ral 9005

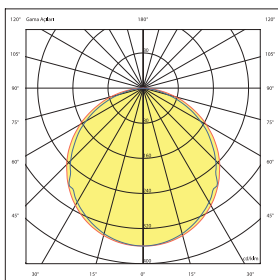

Order Code	W	Lm	CCT	CRI	Kg
03170.60.30.044	47	4240	3000	Ra>80	3,7
03170.60.40.047	47	4460	4000	Ra>80	3,7

500 CORVUS-T

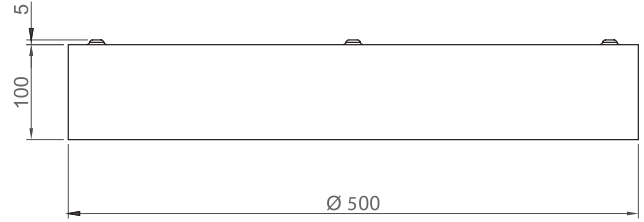

Color Options

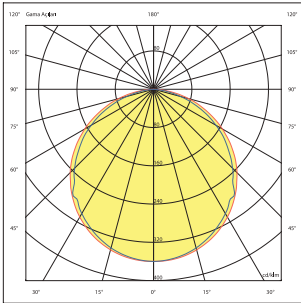

Order Code	W	Lm	CCT	CRI	Kg
03170.50.30.036	38	3430	3000	Ra>80	3,5
03170.50.40.039	38	3610	4000	Ra>80	3,5



380 CORVUS-T

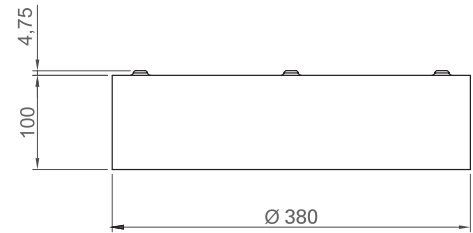

Color Options

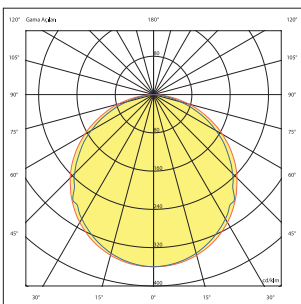
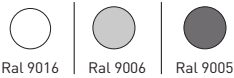

Order Code	W	Lm	CCT	CRI	Kg
03170.38.30.021	20	1800	3000	Ra>80	2,8
03170.38.40.022	20	1900	4000	Ra>80	2,8

GUIDE

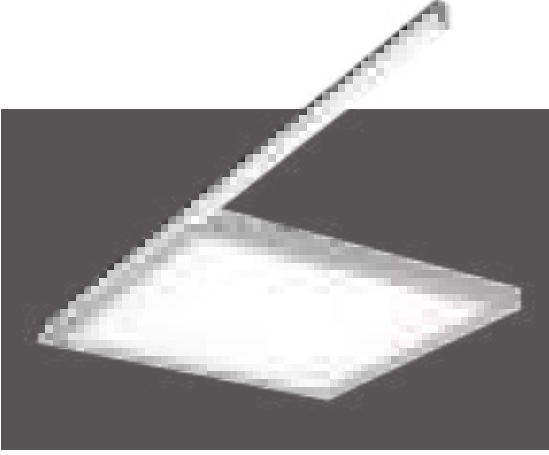

Housing	Electrostatic coated steel sheet
Optics	Highly transmissive opal diffuser
Light Source	High efficacy Mid Power LED with lifetime L80B50 > 50,000h
Driver	Constant current output, Pf>0.90
Supply Voltage	220-240V/50-60Hz
Ambient Temperature	-20C°/+40C°
Options	Dali 3 hour emergency lighting kit

Renk Seçenekleri

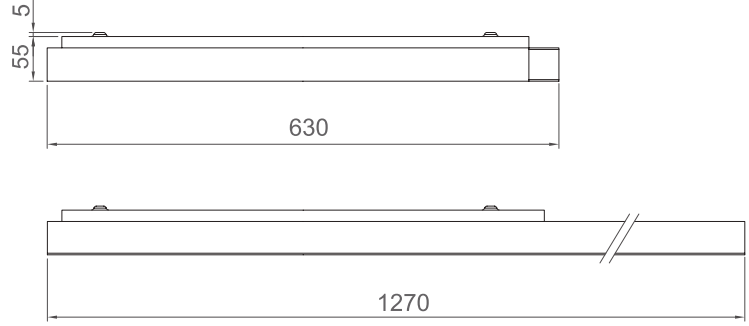
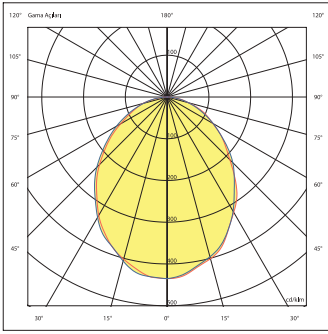

Order Code	W	Lm	CCT	CRI	Kg
03114.66.30.039	35	3900	3000	Ra>80	5,5
03114.66.40.041	35	4080	4100	Ra>80	5,5



TETR's-T

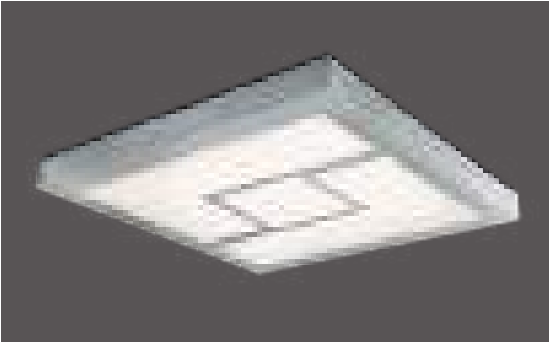

Color Options



Ral 9016



Ral 9006



Ral 9005

Housing	Electrostatic coated steel sheet
Optics	Highly transmissive opal diffuser
Light Source	High efficacy Mid Power LED with lifetime L80B50 > 50,000h
Driver	Constant current output, Pf>0.90
Supply Voltage	220-240V/50-60Hz
Ambient Temperature	-20C°/+40C°
Options	Dali 3 hour emergency lighting kit

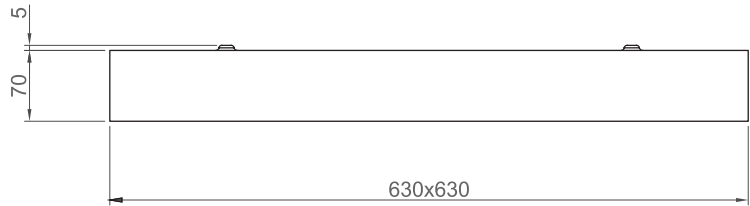
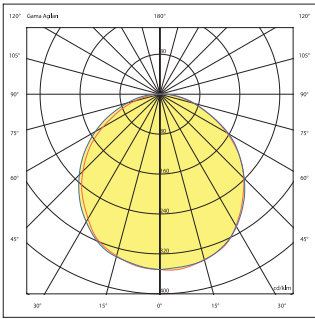

Order Code	W	Lm	CCT	CRI	Kg
03125.66.30.032	28	2930	3000	Ra>80	4,1
03125.66.40.033	28	3100	4000	Ra>80	4,1

DOME-T



Color Options



Housing	Electrostatic coated steel sheet
Optics	Electrostatic coated perforated steel reflector with electrostatic coated steel sheet on the back
Light Source	High efficacy Mid Power LED with lifetime L80B50 > 50,000h
Driver	Constant current output, Pf>0.90
Supply Voltage	220-240V/50-60Hz
Ambient Temperature	-20C°/+40C°
Options	Dali 3 hour emergency lighting kit

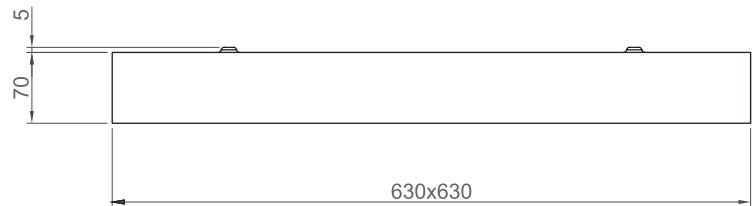
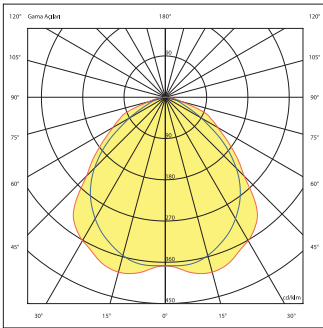

Order Code	W	Lm	CCT	CRI	Kg
03119.66.30.023	29	2320	3000	Ra>80	4,9
03119.66.30.031	41	3170	3000	Ra>80	4,9
03119.66.30.052	60	5280	3000	Ra>80	4,9
03119.66.40.024	29	2450	4000	Ra>80	4,9
03119.66.40.033	41	3360	4000	Ra>80	4,9
03119.66.40.055	60	5600	4000	Ra>80	4,9

TIE-T

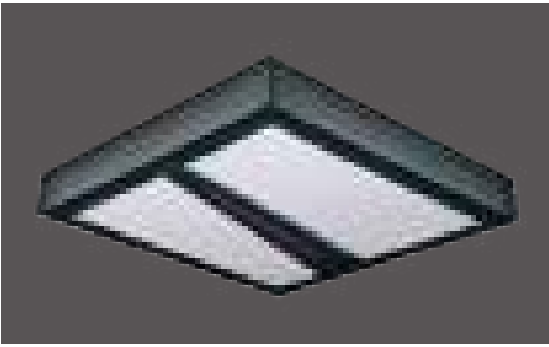

Color Options



Ral 9016

Ral 9006

Ral 9005

Housing	Electrostatic coated steel sheet
Optics	Highly transmissive opal diffuser
Light Source	High efficacy Mid Power LED with lifetime L80B50 > 50,000h
Driver	Constant current output, Pf>0.90
Supply Voltage	220-240V/50-60Hz
Ambient Temperature	-20C°/+40C°
Options	Dali 3 hour emergency lighting kit

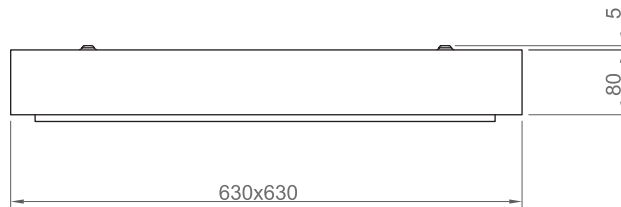
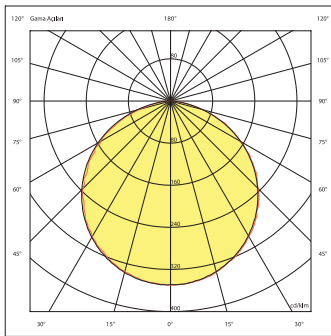

Order Code	W	Lm	CCT	CRI	Kg
03128.66.30.032	33	3200	3000	Ra>80	4,1
03128.66.40.034	33	3350	4000	Ra>80	4,1



Housing	Electrostatic coated steel sheet
Optics	Highly transmissive opal diffuser
Light Source	High efficacy Mid Power LED with lifetime L80B50 > 50,000h
Driver	Constant current output, Pf>0.90
Supply Voltage	220-240V/50-60Hz
Ambient Temperature	-20C°/+40C°
Options	Dali 3 hour emergency lighting kit

Color Options

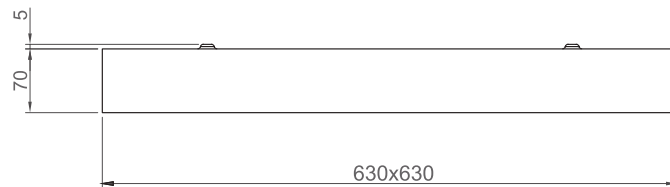
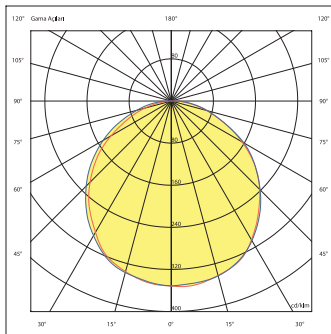

Order Code	W	Lm	CCT	CRI	Kg
03149.66.30.023	29	2300	3000	Ra>80	4,3
03149.66.30.033	41	3300	3000	Ra>80	4,3
03149.66.40.024	29	2450	4000	Ra>80	4,3
03149.66.40.035	41	3500	4000	Ra>80	4,3

STYLE 600



Color Options



Ral 9016



Ral 9006



Ral 9005

Housing	Electrostatic coated aluminum profile
Optics	Highly transmissive opal diffuser
Light Source	High efficacy Mid Power LED with lifetime L80B50 > 50,000h
Driver	Constant current output, Pf>0.90
Supply Voltage	220-240V/50-60Hz
Ambient Temperature	-20C°/+40C°
Options	Dali 3 hour emergency lighting kit

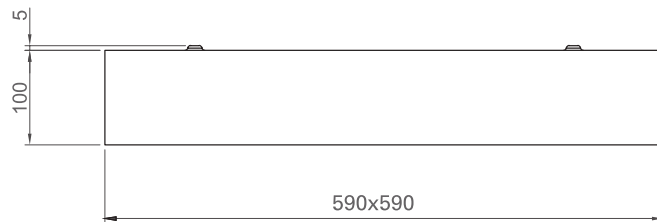
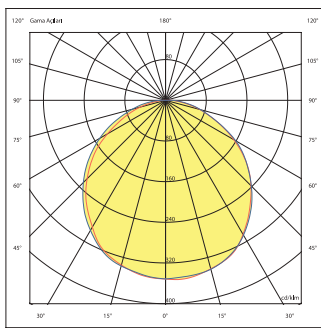

Order Code	W	Lm	CCT	CRI	Kg
03137.66.30.032	28	2800	3000	Ra>80	3,9
03137.66.40.033	28	2950	4000	Ra>80	3,9



Housing	Electrostatic coated aluminum profile
Optics	Highly transmissive opal diffuser
Light Source	High efficacy Mid Power LED with lifetime L80B50 > 50,000h
Driver	Constant current output, Pf>0.90
Supply Voltage	220-240V/50-60Hz
Ambient Temperature	-20C°/+40C°
Options	Dali 3 hour emergency lighting kit

Color Options

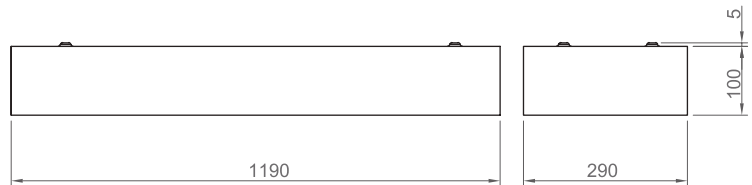
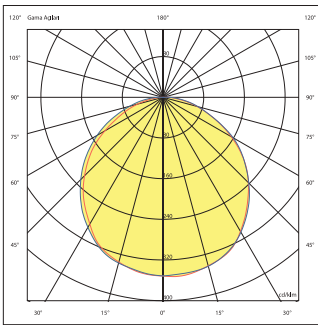

Order Code	W	Lm	CCT	CRI	Kg
03137.31.30.032	28	2800	3000	Ra>80	4,2
03137.31.40.033	28	2950	4000	Ra>80	4,2

FLAT-T 600



Color Options



Ral 9016



Ral 9006



Ral 9005

Housing	Electrostatic coated steel sheet
Optics	Highly transmissive opal diffuser
Light Source	High efficacy Mid Power LED with lifetime L80B50 > 50,000h
Driver	Constant current output, Pf>0.90
Supply Voltage	220-240V/50-60Hz
Ambient Temperature	-20C°/+40C°
Options	Dali 3 hour emergency lighting kit

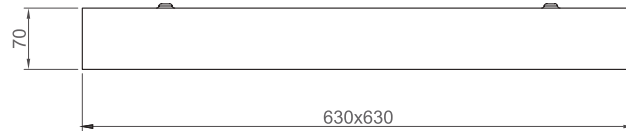
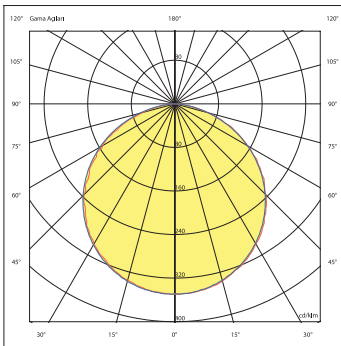

Order Code	W	Lm	CCT	CRI	Kg
03135.66.30.033	28	3250	3000	Ra>80	4,0
03135.66.30.036	33	3600	3000	Ra>80	4,0
03135.66.30.040	35	4000	3000	Ra>80	4,0
03135.66.40.034	28	3350	4000	Ra>80	4,0
03135.66.40.037	33	3700	4000	Ra>80	4,0
03135.66.40.041	35	4100	4000	Ra>80	4,0

1230 FLAT-T



Housing	Electrostatic coated steel sheet
Optics	Highly transmissive opal diffuser
Light Source	High efficacy Mid Power LED with lifetime L80B50 > 50,000h
Driver	Constant current output, Pf>0.90
Supply Voltage	220-240V/50-60Hz
Ambient Temperature	-20C°/+40C°
Options	Dali 3 hour emergency lighting kit

Color Options

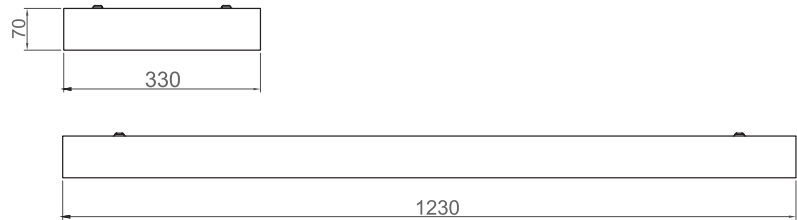
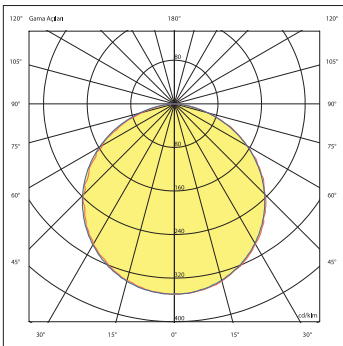
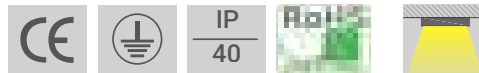

Order Code	W	Lm	CCT	CRI	Kg
03135.31.30.032	28	3200	3000	Ra>80	4,5
03135.31.40.033	28	3300	4000	Ra>80	4,5

FLAT-T 300



Color Options



Ral 9016



Ral 9006



Ral 9005

Housing	Electrostatic coated steel sheet
Optics	Highly transmissive opal diffuser
Light Source	High efficacy Mid Power LED with lifetime L80B50 > 50,000h
Driver	Constant current output, Pf>0.90
Supply Voltage	220-240V/50-60Hz
Ambient Temperature	-20C°/+40C°
Options	Dali 3 hour emergency lighting kit

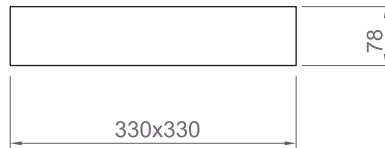
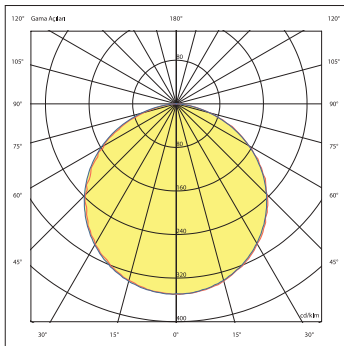

Order Code	W	Lm	CCT	CRI	Kg
03135.33.30.008	9	800	3000	Ra>80	2,0
03135.33.30.018	18	1700	3000	Ra>80	2,0
03135.33.40.009	9	850	4000	Ra>80	2,0
03135.33.40.018	18	1800	4000	Ra>80	2,0

GLARE-T



Color Options



Ral 9016



Ral 9006



Ral 9005

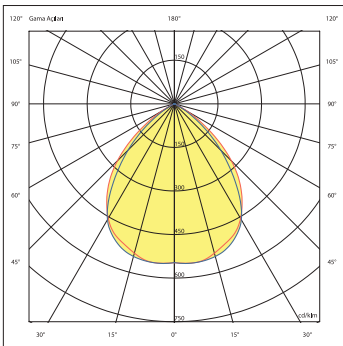

Housing	Electrostatic coated steel sheet
Optics	Highly transmissive opal diffuser
Reflector	Deglarng glossary aluminum reflector (UGR<19)
Light Source	High efficacy Mid Power LED with lifetime L80B50 > 50,000h
Driver	Constant current output, Pf>0.90
Supply Voltage	220-240V/50-60Hz
Ambient Temperature	-20C°/+40C°
Options	Dali 3 hour emergency lighting kit

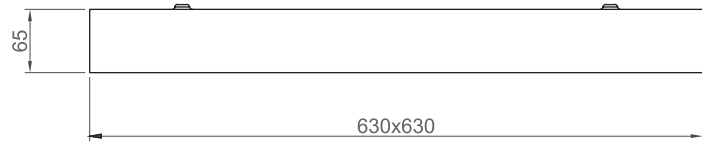

Order Code	W	Lm	CCT	CRI	Kg
03500.66.30.028	35	3135	3000	Ra>80	4,9
03500.66.40.030	35	3300	4000	Ra>80	4,9

ORION ALNITAK



Housing	Electrostatic coated aluminum profile
Optics	Highly transmissive opal diffuser
Light Source	High efficacy Mid Power LED with lifetime L80B50 > 50,000h
Driver	Constant current output, Pf>0.90
Supply Voltage	220-240V/50-60Hz
Ambient Temperature	-20C°/+40C°
Options	Dali 3 hour emergency lighting kit

Color Options

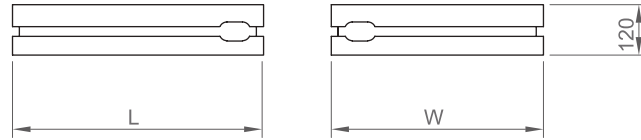
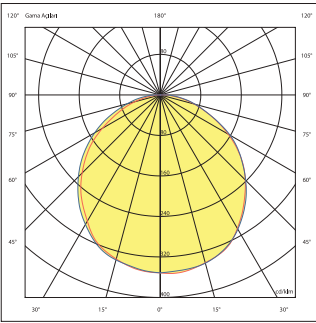

Order Code	W	Lm	CCT	CRI	W	L	H	Kg
03101.33.30.008	9	800	3000	Ra>80	310	310	120	2,0
03101.66.30.032	28	3200	3000	Ra>80	595	595	120	3,8
03101.66.30.036	33	3600	3000	Ra>80	595	595	120	3,8
03101.33.40.009	9	850	4000	Ra>80	310	310	120	2,0
03101.66.40.033	28	3300	4000	Ra>80	595	595	120	3,8
03102.66.40.039	33	3700	4000	Ra>80	595	595	120	3,8



7 | WALL LUMINAIRES

MIRROLINE Mirror Light



Housing	Electrostatic coated aluminum profile
Optics	Highly transmissive opal PC diffuser
Light Source	High efficacy Mid Power LED with lifetime L80B50 > 50,000h
Driver	Constant current output, Pf>0.90
Supply Voltage	220-240V/50-60Hz
Ambient Temperature	-20C°/+40C°
Options	Dali 3 hour emergency lighting kit

Color Options

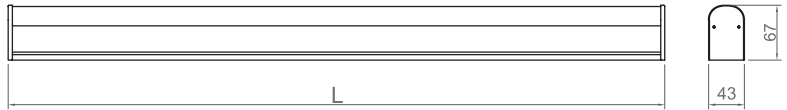
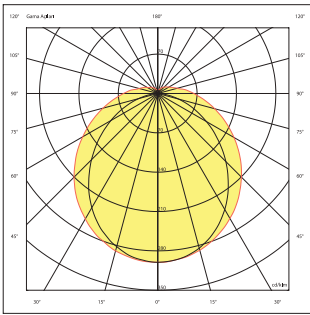

Order Code	W	Lm	CCT	CRI	L (mm)	Kg
01180.46.30.016	14	1670	3000	Ra>80	580	0,6
01180.46.30.032	27	3220	3000	Ra>80	1130	1,1
01180.46.30.048	41	4880	3000	Ra>80	1680	1,5
01180.46.40.018	14	1800	4000	Ra>80	580	0,6
01180.46.40.035	27	3500	4000	Ra>80	1130	1,1
01180.46.40.052	41	5290	4000	Ra>80	1680	1,5

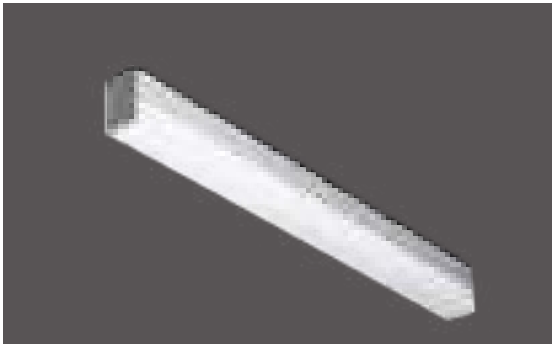

Housing	Electrostatic coated aluminum profile
Optics	Highly transmissive opal PC diffuser
Light Source	High efficacy Mid Power LED with lifetime L80B50 > 50,000h
Driver	Constant current output, Pf>0.90
Supply Voltage	220-240V/50-60Hz
Ambient Temperature	-20C°/+40C°
Options	Dali 3 hour emergency lighting kit

Color Options



Ral 9006

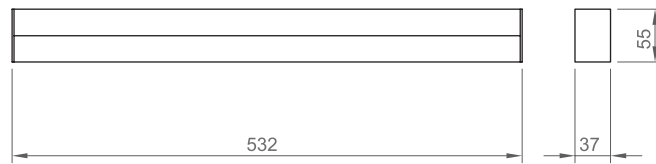
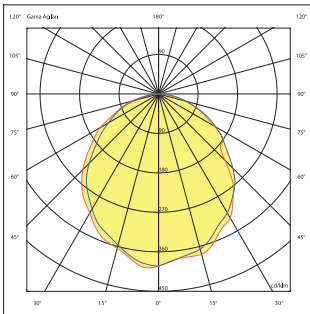

Order Code	W	Lm	CCT	CRI	Kg
01183.45.30.008	10	800	3000	Ra>80	0,5
01183.45.40.009	10	900	4000	Ra>80	0,5





Housing	Electrostatic coated steel sheet
Optics	Highly transmissive opal diffuser
Light Source	High efficacy Mid Power LED with lifetime L80B50 > 50,000h
Driver	Constant current output, Pf>0.90
Supply Voltage	220-240V/50-60Hz
Ambient Temperature	-20C°/+40C°
Options	Dali 3 hour emergency lighting kit

Color Options

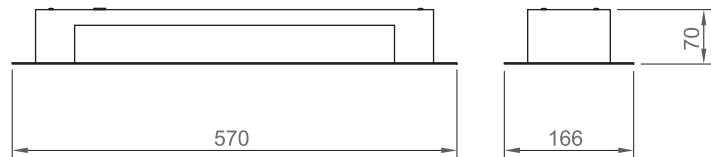
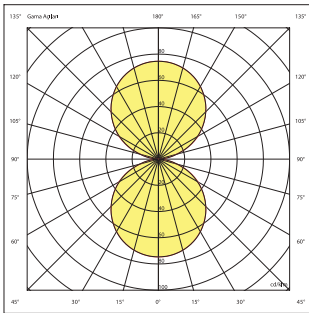

Order Code	W	Lm	CCT	CRI	Kg
06144.15.30.013	13	1300	3000	Ra>80	3,2
06144.15.30.026	26	2600	3000	Ra>80	3,2
06144.15.40.014	13	1400	4000	Ra>80	3,2
06144.15.40.027	26	2700	4000	Ra>80	3,2

CALM



Color Options



Ral 9016



Ral 9006



Ral 9005

Housing	Electrostatic coated steel sheet
Light Source	High efficacy Mid Power LED with lifetime L80B50 > 50,000h
Driver	Constant current output, Pf>0.90
Supply Voltage	220-240V/50-60Hz
Ambient Temperature	-20C°/+40C°

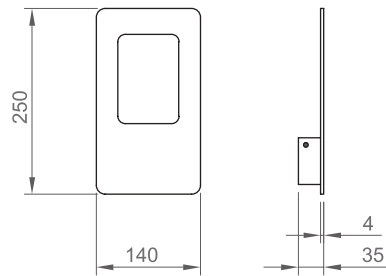
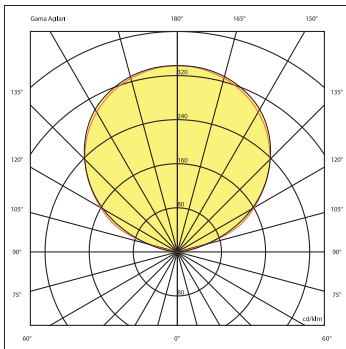

Order Code	W	Lm	CCT	CRI	Kg
06191.12.30.008	11	800	3000	Ra>80	0,5
06191.12.40.009	11	900	4000	Ra>80	0,5

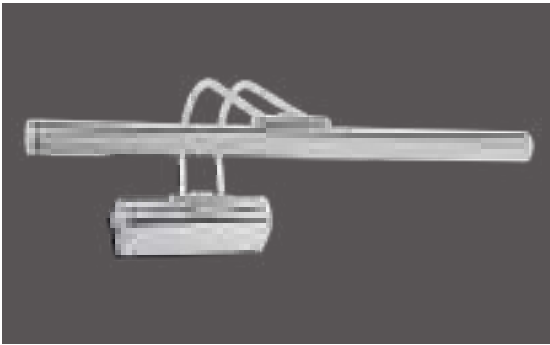

Housing	Nickel chrome plated brass
Light Source	High efficacy Mid Power LED with lifetime L80B50 > 50,000h
Driver	Constant current output, Pf>0.90
Supply Voltage	220-240V/50-60Hz
Ambient Temperature	-20C°/+40C°

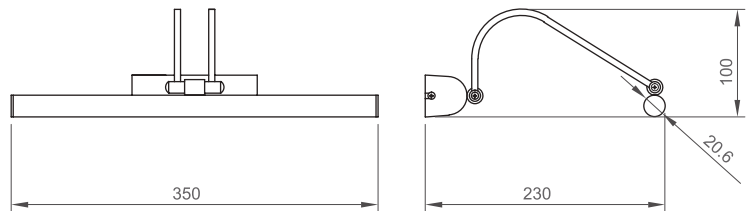
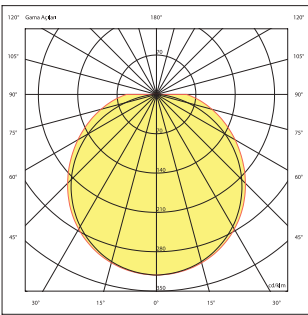

Order Code	W	Lm	CCT	CRI	Kg
61169.42.40.005	5	500	4000	Ra>80	0,2

COMET

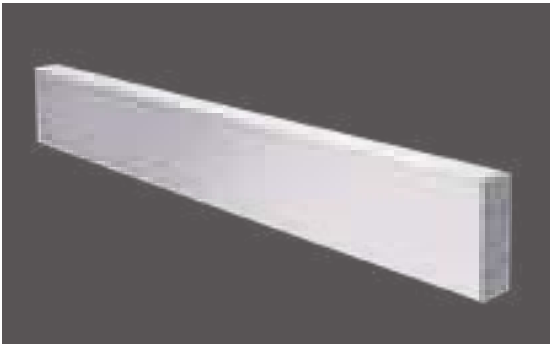

Housing	Electrostatic coated steel sheet
Light Source	High efficacy Mid Power LED with lifetime L80B50 > 50,000h
Driver	Constant current output, Pf>0.90
Supply Voltage	220-240V/50-60Hz
Ambient Temperature	-20C°/+40C°

Color Options

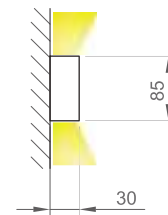
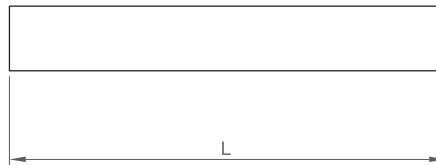
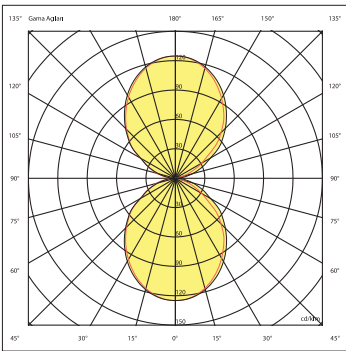
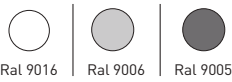

Order Code	W	Lm	CCT	CRI	Kg
06600.60.30.017	20	1700	3000	Ra>80	0,8
06600.60.40.018	20	1800	4000	Ra>80	0,8



Housing	Electrostatic coated steel sheet
Glass	Clear tempered glass
Light Source	High efficacy Mid Power LED with lifetime L80B50 > 50,000h
Driver	Constant current output, Pf>0.90
Supply Voltage	220-240V/50-60Hz
Ambient Temperature	-20C°/+40C°

Color Options  Ral 9016

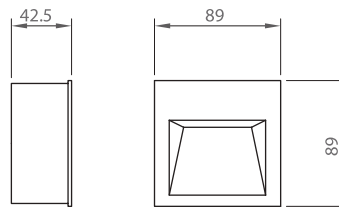
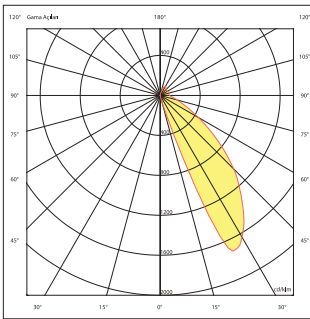

Gypsum Wall

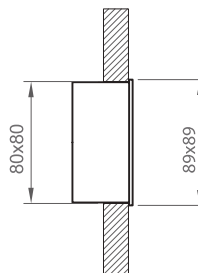

Concrete Wall

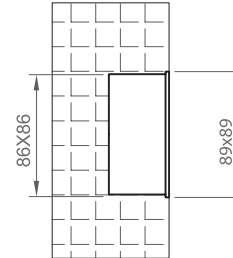

Order Code	W	Lm	CCT	CRI	Kg
06201.99.30.002	2	170	3000	Ra>80	0,3
06201.99.40.002	2	200	3000	Ra>80	0,3



8 | COVE LIGHTING

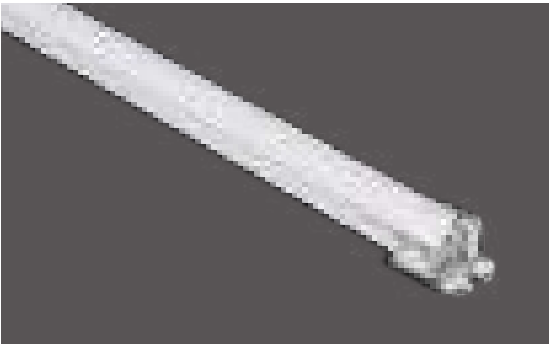

Housing	Electrostatic coated aluminum profile
Diffuser	Highly transmissive opal PC diffuser
Light Source	High efficacy Mid Power LED with lifetime L80B50 > 50,000h
Driver	Constant voltage output, 24V DC
Supply Voltage	220-240V/50-60Hz
Ambient Temperature	-20C°/+40C°

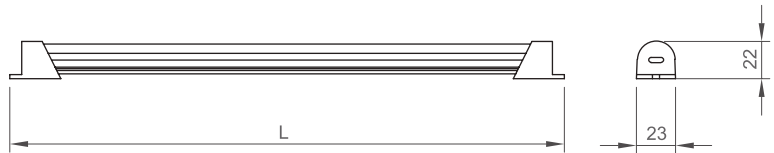
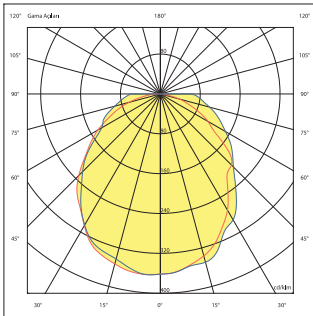

Order Code	W	Lm	CCT	CRI	Volt	L	Kg
06135.13.30.001	1,6	140	3000	Ra>80	24	130	0,05
06135.23.30.002	3,2	280	3000	Ra>80	24	230	0,08
06135.53.30.007	8	710	3000	Ra>80	24	530	0,15
06135.10.30.016	16	1420	3000	Ra>80	24	1030	0,25
06135.12.30.017	19,2	1710	3000	Ra>80	24	1230	0,33
06135.15.30.021	24	2140	3000	Ra>80	24	1530	0,38
06135.13.40.001	1,6	150	4000	Ra>80	24	130	0,05
06135.23.40.003	3,2	300	4000	Ra>80	24	230	0,08
06135.53.40.007	8	755	4000	Ra>80	24	530	0,15
06135.10.40.017	16	1510	4000	Ra>80	24	1030	0,25
06135.12.40.019	19,2	1810	4000	Ra>80	24	1230	0,33
06135.15.40.022	24	2260	4000	Ra>80	24	1530	0,38



SPACE

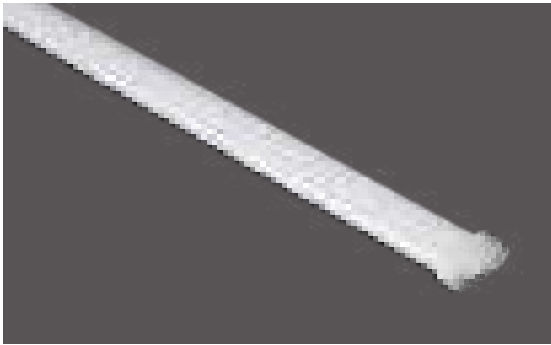

Housing	Aluminum profile
Diffuser	Highly transmissive opal PC diffuser
Light Source	High efficacy Mid Power LED with lifetime L80B50 > 50,000h
Driver	Constant voltage output, 24V DC
Supply Voltage	220-240V/50-60Hz
Ambient Temperature	-20C°/+40C°

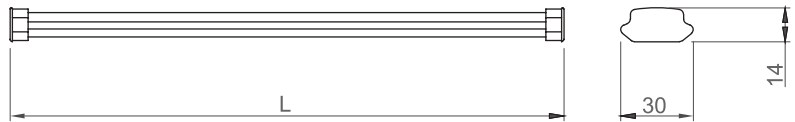
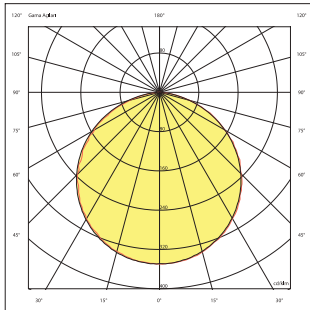

Order Code	W	Lm	CCT	CRI	Volt	L	Kg
08131.05.30.007	7	750	3000	Ra>80	24	500	0,25
08131.10.30.014	14	1400	3000	Ra>80	24	1000	0,40
08131.05.40.007	7	780	4000	Ra>80	24	500	0,25
08131.10.40.014	14	1450	4000	Ra>80	24	1000	0,40



9 | STERILE ROOM LIGHTING

SHIELD-G 600



Color Options



Housing	Electrostatic coated steel sheet
Glass	Clear tempered glass
Optics	Highly transmissive opal diffuser
Light Source	High efficacy Mid Power LED with lifetime L80B50 > 50,000h
Driver	Constant current output, Pf>0.90
Supply Voltage	220-240V/50-60Hz
Ambient Temperature	-20C°/+40C°
Options	Dali 3 hour emergency lighting kit

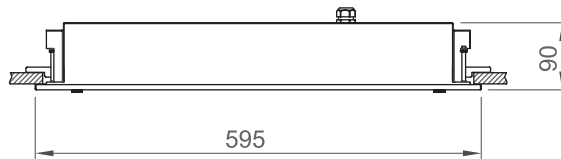
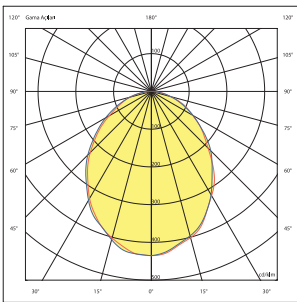
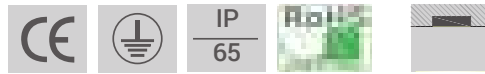

Order Code	W	Lm	CCT	CRI	WxL	Cut-out (mm)	Kg
02125.66.30.029	28	2900	3000	Ra>80	595x595	580x580	7,3
02125.66.30.032	33	3200	3000	Ra>80	595x595	580x580	7,3
02125.66.30.035	35	3500	3000	Ra>80	595x595	580x580	7,3
02125.66.40.030	28	3000	4000	Ra>80	595x595	580x580	7,3
02125.66.40.032	33	3300	4000	Ra>80	595x595	580x580	7,3
02125.66.40.036	35	3600	4000	Ra>80	595x595	580x580	7,3



EVEN-G 600



Housing	Electrostatic coated steel sheet
Optics	Highly transmissive opal diffuser
Light Source	High efficacy Mid Power LED with lifetime L80B50 > 50,000h
Driver	Constant current output, Pf>0.90
Supply Voltage	220-240V/50-60Hz
Ambient Temperature	-20C°/+40C°
Options	Dali 3 hour emergency lighting kit

Color Options

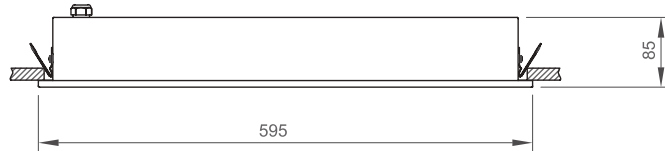
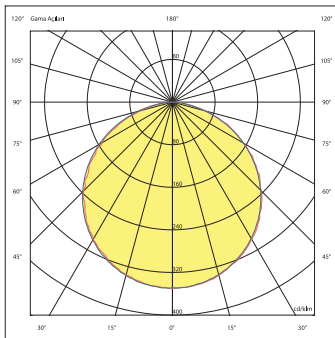

Order Code	W	Lm	CCT	CRI	WxL	Cut-out (mm)	Kg
02142.66.30.033	28	3300	3000	Ra>80	595x595	580x580	3,1
02142.66.30.036	33	3600	3000	Ra>80	595x595	580x580	3,1
02142.66.40.034	28	3400	4000	Ra>80	595x595	580x580	3,1
02142.66.40.037	33	3700	4000	Ra>80	595x595	580x580	3,1

1200 EVEN-G



Housing	Electrostatic coated steel sheet
Optics	Highly transmissive opal diffuser
Light Source	High efficacy Mid Power LED with lifetime L80B50 > 50,000h
Driver	Constant current output, Pf>0.90
Supply Voltage	220-240V/50-60Hz
Ambient Temperature	-20C°/+40C°
Options	Dali 3 hour emergency lighting kit

Color Options

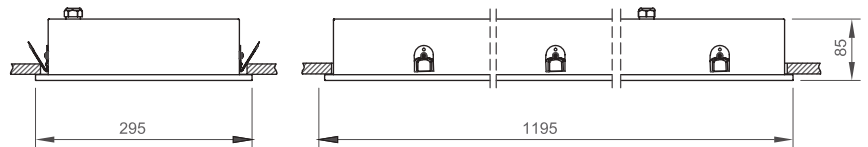
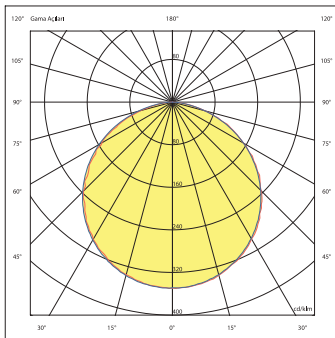
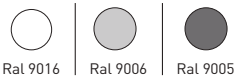

Order Code	W	Lm	CCT	CRI	WxL	Cut-out (mm)	Kg
02142.31.30.032	33	3200	3000	Ra>80	295x1195	280x1180	3,5
02142.31.30.040	52	4400	3000	Ra>80	295x1195	280x1180	3,5
02142.31.40.033	33	3300	4000	Ra>80	295x1195	280x1180	3,5
02142.31.40.041	52	4500	4000	Ra>80	295x1195	280x1180	3,5

WINK-G



Color Options

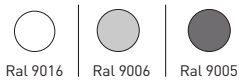

Housing	Electrostatic coated steel sheet
Glass	Clear tempered glass
Optics	Opal lens and electrostatic coated perforated steel reflector with electrostatic coated steel sheet on the back
Light Source	High efficacy Mid Power LED with lifetime L80B50 > 50,000h
Driver	Constant current output, Pf>0.90
Supply Voltage	220-240V/50-60Hz
Ambient Temperature	-20C°/+40C°
Options	Dali 3 hour emergency lighting kit

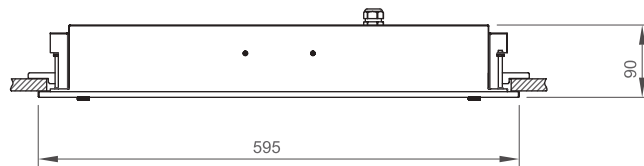
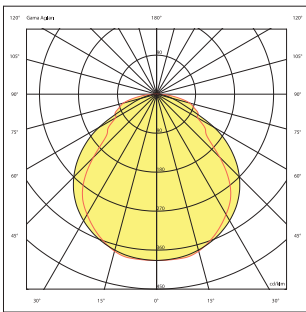

Order Code	W	Lm	CCT	CRI	WxL	Cut-out (mm)	Kg
02141.66.30.024	32	2400	3000	Ra>80	595x595	580x580	6,1
02141.66.30.047	60	4700	3000	Ra>80	595x595	580x580	6,1
02141.66.40.025	32	2500	4000	Ra>80	595x595	580x580	6,1
02141.66.40.048	60	4800	4000	Ra>80	595x595	580x580	6,1

surface mounted sterile **SHIELD-T**



Color Options

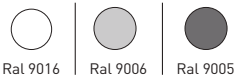

Housing	Electrostatic coated steel sheet
Glass	Clear tempered glass
Optics	Highly transmissive opal diffuser
Light Source	High efficacy Mid Power LED with lifetime L80B50 > 50,000h
Driver	Constant current output, Pf>0.90
Supply Voltage	220-240V/50-60Hz
Ambient Temperature	-20C°/+40C°
Options	Dali 3 hour emergency lighting kit

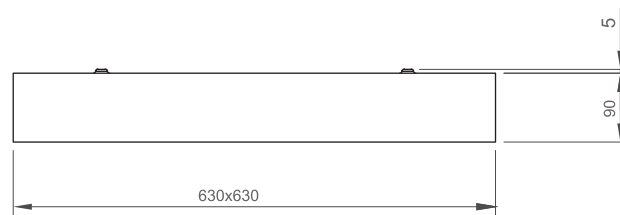
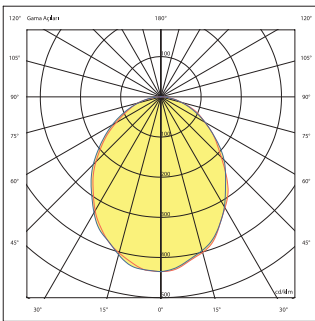

Order Code	W	Lm	CCT	CRI	Kg
04101.66.30.029	28	2900	3000	Ra>80	7,5
04101.66.30.033	33	3200	3000	Ra>80	7,5
04101.66.30.035	35	3500	3000	Ra>80	7,5
04101.66.40.030	28	3000	4000	Ra>80	7,5
04101.66.40.032	33	3300	4000	Ra>80	7,5
04101.66.40.036	35	3600	4000	Ra>80	7,5



10 | **INDUSTRIAL
LIGHTING**

SUMBA

waterproof lighting





Housing	Extruded aluminum profile
Optics	Highly transmissive PC opal diffuser
Light Source	High efficacy Mid Power LED with lifetime L80B50 > 50,000h
Driver	Constant current output, Pf>0.90
Supply Voltage	220-240V/50-60Hz
Ambient Temperature	-20C°/+40C°
Options	Dali 3 hour emergency lighting kit

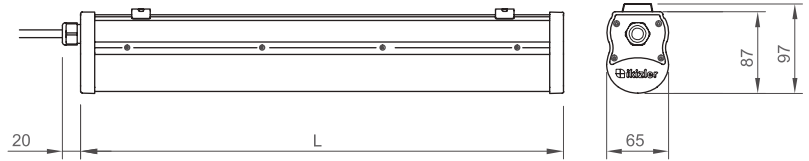
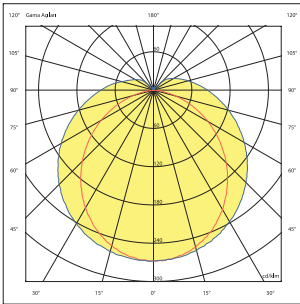

Order Code	W	Lm	CCT	CRI	L (mm)	Kg
07102.06.30.021	19	2000	3000	Ra>80	600	1,4
07102.09.30.022	20	2180	3000	Ra>80	880	2,0
07102.09.30.031	29	3000	3000	Ra>80	880	2,0
07102.09.30.042	42	4160	3000	Ra>80	880	2,0
07102.12.30.029	29	2900	3000	Ra>80	1160	2,7
07102.12.30.042	40	4000	3000	Ra>80	1160	2,7
07102.15.30.051	48	4980	3000	Ra>80	1440	3,3
07102.06.40.022	19	2100	4000	Ra>80	600	1,6
07102.09.40.023	20	2300	4000	Ra>80	880	2,0
07102.09.40.032	29	3170	4000	Ra>80	880	2,0
07102.09.40.044	42	4400	4000	Ra>80	880	2,0
07102.12.40.030	29	3080	4000	Ra>80	1160	2,7
07102.12.40.043	40	4220	4000	Ra>80	1160	2,7
07102.15.40.053	48	5280	4000	Ra>80	1440	3,3

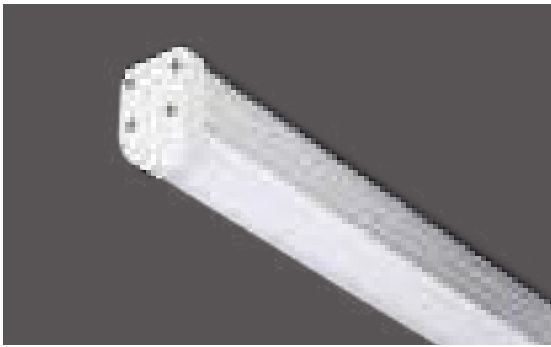

Housing	Extruded aluminum profile
Optics	Highly transmissive PC opal diffuser
Light Source	High efficacy Mid Power LED with lifetime L80B50 > 50,000h
Driver	Constant current output, Pf>0.90
Supply Voltage	220-240V/50-60Hz
Ambient Temperature	-20C°/+40C°
Options	Dali 3 hour emergency lighting kit

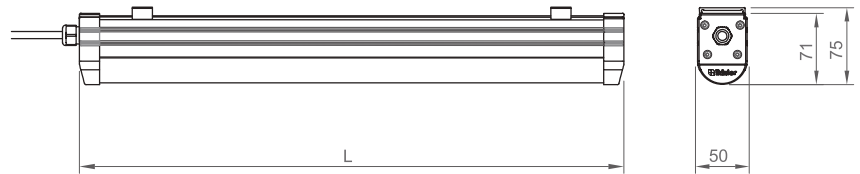
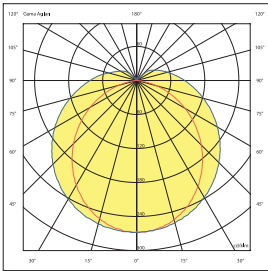

Order Code	W	Lm	CCT	CRI	W x L	Kg
07104.03.30.011	11	1285	3000	Ra>80	390	0,5
07104.05.30.017	17	1975	3000	Ra>80	510	0,7
07104.07.30.023	21	2570	3000	Ra>80	750	1,0
07104.07.30.030	29	3350	3000	Ra>80	750	1,0
07104.12.30.026	23	2900	3000	Ra>80	1230	1,6
07104.12.30.038	35	4280	3000	Ra>80	1230	1,6
07104.12.30.050	48	5680	3000	Ra>80	1230	1,6
07104.15.30.046	42	5130	3000	Ra>80	1470	1,9
07104.15.30.060	57	6690	3000	Ra>80	1470	1,9
<hr/>						
07104.03.40.012	11	1360	4000	Ra>80	390	0,5
07104.05.40.017	17	2090	4000	Ra>80	510	0,7
07104.07.40.021	21	2700	4000	Ra>80	750	1,0
07104.07.40.031	29	3500	4000	Ra>80	750	1,0
07104.12.40.027	23	3100	4000	Ra>80	1230	1,6
07104.12.40.040	35	4500	4000	Ra>80	1230	1,6
07104.12.40.053	48	5900	4000	Ra>80	1230	1,6
07104.15.40.048	42	5400	4000	Ra>80	1470	1,9
07104.15.40.066	57	7100	4000	Ra>80	1470	1,9



Housing	Impact resistant PC
Optics	Highly transmissive opal PC diffuser
Light Source	High efficacy Mid Power LED with lifetime L80B50 > 50,000h
Driver	Constant current output, Pf>0.90
Supply Voltage	220-240V/50-60Hz
Ambient Temperature	-20C°/+40C°
Options	Dali 3 hour emergency lighting kit

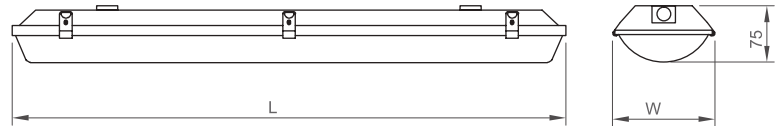
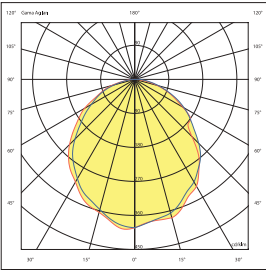

Order Code	W	Lm	CCT	CRI	W x L	Kg
07101.07.30.011	10	1100	3000	Ra>80	95x680	0,98
07101.16.30.039	35	3900	3000	Ra>80	95x1580	2,1
07101.12.30.024	20	2400	3000	Ra>80	95x1200	1,6
07101.12.30.032	29	3200	3000	Ra>80	95x1200	1,6
07101.12.30.043	41	4300	3000	Ra>80	95x1200	1,6
07101.07.40.012	10	1200	4000	Ra>80	95x680	0,98
07101.16.40.040	35	4000	4000	Ra>80	95x1580	2,1
07101.12.40.025	20	2500	4000	Ra>80	95x1200	1,6
07101.12.40.033	29	3300	4000	Ra>80	95x1200	1,6
07101.12.40.045	41	4500	4000	Ra>80	95x1200	1,6

DOVE



Housing	Impact resistant PC
Optics	Highly transmissive opal PC diffuser
Light Source	High efficacy Mid Power LED with lifetime L80B50 > 50,000h
Driver	Constant current output, Pf>0.90
Supply Voltage	220-240V/50-60Hz
Ambient Temperature	-20C°/+40C°
Options	Dali 3 hour emergency lighting kit

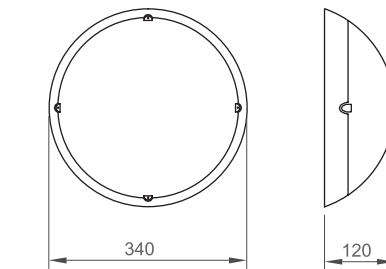
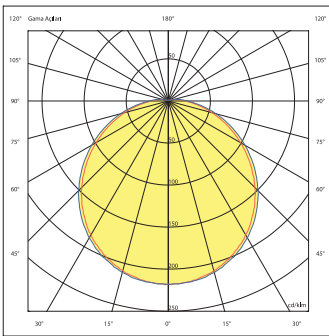

Order Code	W	Lm	CCT	CRI	Kg
06152.34.30.014	15	1400	3000	Ra>80	1,3
06152.34.30.017	18	1700	3000	Ra>80	1,3
06152.34.30.026	25	2600	3000	Ra>80	1,3
06152.34.40.015	15	1500	4000	Ra>80	1,3
06152.34.40.018	18	1800	4000	Ra>80	1,3
06152.34.40.027	25	2700	4000	Ra>80	1,3

RISING

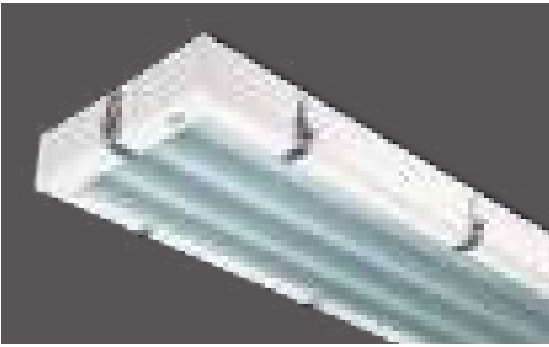

Color Options

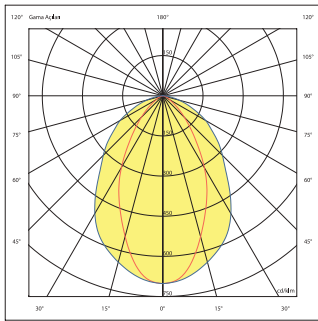
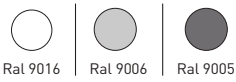

Housing	Electrostatic coated steel sheet
Reflector	Anodized aluminum
Glass	Tempered, sand-blasted glass
Optics	Highly transmissive opal PC diffuser
Light Source	High efficacy Mid Power LED with lifetime L80B50 > 50,000h
Driver	Constant current output, Pf>0.90
Supply Voltage	220-240V/50-60Hz
Ambient Temperature	-20C°/+40C°

Options Dali
3 hour emergency lighting kit

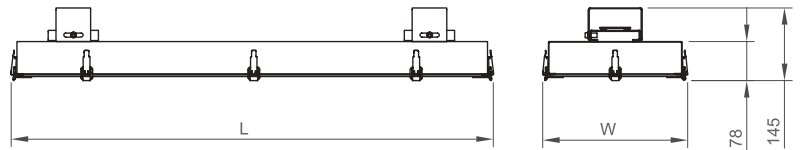

Order Code	W	Lm	CCT	CRI	W x L	Kg
07301.06.40.056	47	5670	4000	Ra>80	216x633	5,8
07301.09.40.085	70	8500	4000	Ra>80	216x915	7,0
07301.12.40.113	94	11350	4000	Ra>80	216x1197	8,1
07301.15.40.142	120	14200	4000	Ra>80	216x1477	9,2
07301.12.40.184	160	18400	4000	Ra>80	291x1197	11,5
07301.15.40.225	200	22500	4000	Ra>80	291x1477	13,0

GETTO

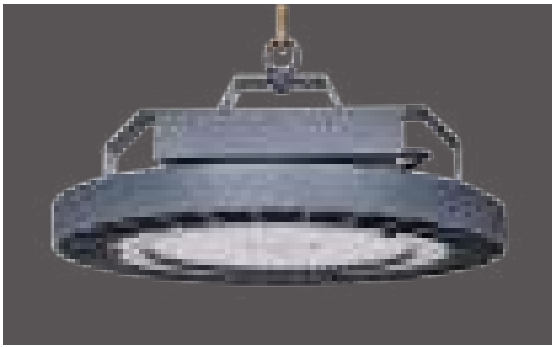

Housing	Die-cast aluminum with electrostatic coating
Optics	Clear optic lens
Light Source	High efficacy Mid Power LED with lifetime L80B50 > 50,000h
Driver	Constant current output, Pf>0.90
Supply Voltage	220-240V/50-60Hz
Ambient Temperature	-20C°/+40C°
Options	Dali 3 hour emergency lighting kit

Color Options

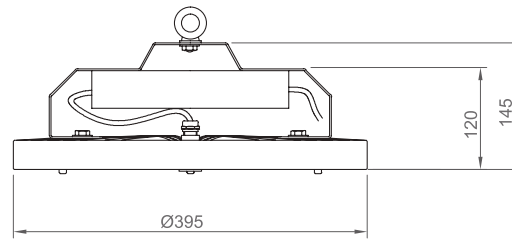
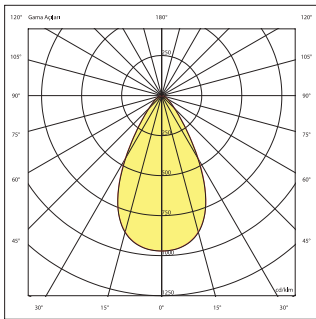

Order Code	W	Lm	CCT	CRI	Kg
07306.39.40.080	60	8340	4000	Ra>80	4,2
07306.39.40.120	90	12500	4000	Ra>80	4,2
07306.39.40.150	124	17240	4000	Ra>80	4,2
07306.39.40.190	160	22240	4000	Ra>80	4,2





POTENT

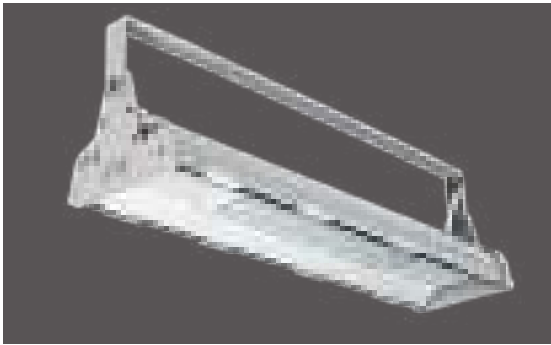

Housing	Die-cast aluminum with electrostatic coating
Optics	Clear optic lens
Glass	Tempered and clear
Light Source	High efficacy Mid Power LED with lifetime L80B50 > 50,000h
Driver	Constant current output, Pf>0.90
Supply Voltage	220-240V/50-60Hz
Ambient Temperature	-20C°/+40C°
Options	Dali 3 hour emergency lighting kit

Color Options

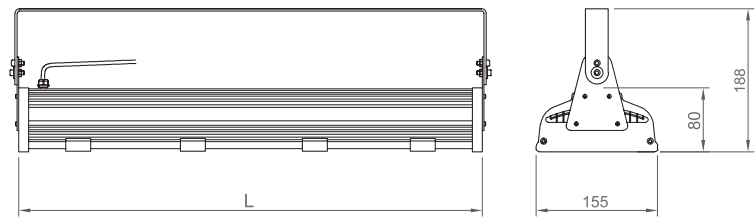
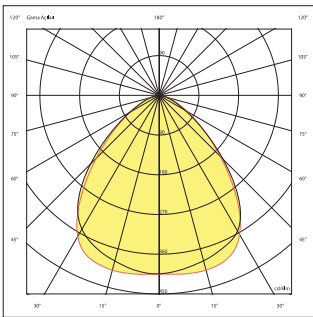

Order Code	W	Lm	CCT	CRI	L (mm)	Kg
07303.03.30.060	60	6300	3000	Ra>80	370	3,3
07303.06.30.099	90	9900	3000	Ra>80	600	3,3
07303.06.30.132	120	13200	3000	Ra>80	600	4,9
07303.03.40.070	60	7000	4000	Ra>80	370	3,3
07303.06.40.108	90	10800	4000	Ra>80	600	3,3
07303.06.40.144	120	14400	4000	Ra>80	600	4,9



11 | OUTDOOR LIGHTING

BEAM D



Housing	Die-cast aluminum with electrostatic coating
Reflector	Anodized aluminum
Glass	Tempered and clear
Light Source	High efficacy COB LED with lifetime L80B50 > 50,000h
Driver	Constant current output, Pf>0.90
Supply Voltage	220-240V/50-60Hz
Ambient Temperature	-20C°/+40C°

Color Options



Antrasit

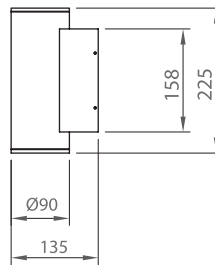
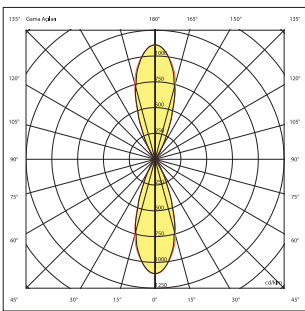

Order Code	W	Lm	CCT	CRI	Kg
06602.91.30.022	2x13	2x1200	3000	Ra>80	1,8
06602.91.40.023	2x13	2x1300	4000	Ra>80	1,8

BEAM S



Housing	Die-cast aluminum with electrostatic coating
Reflector	Anodized aluminum
Glass	Tempered and clear
Light Source	High efficacy COB LED with lifetime L80B50 > 50,000h
Driver	Constant current output, Pf>0.90
Supply Voltage	220-240V/50-60Hz
Ambient Temperature	-20C°/+40C°

Color Options



Antrasit

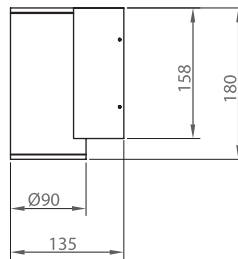
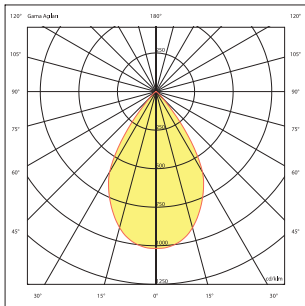

Order Code	W	Lm	CCT	CRI	Kg
06602.91.30.011	13	1200	3000	Ra>80	1,6
06602.91.40.012	13	1300	4000	Ra>80	1,6

BEAM T



Housing	Die-cast aluminum with electrostatic coating
Reflector	Anodized aluminum
Glass	Tempered and clear
Light Source	High efficacy COB LED with lifetime L80B50 > 50,000h
Driver	Constant current output, Pf>0.90
Supply Voltage	220-240V/50-60Hz
Ambient Temperature	-20C°/+40C°

Color Options

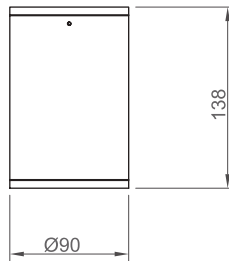
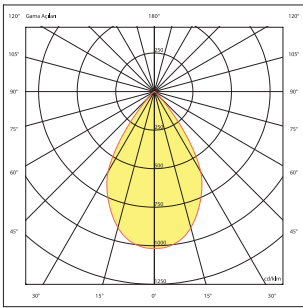

Order Code	W	Lm	CCT	CRI	Kg
05260.90.30.011	12	1100	3000	Ra>80	0,65
05260.90.40.012	12	1200	5000	Ra>80	0,65

PLATE



Housing	Die-cast aluminum with electrostatic coating
Diffuser	Highly transmissive opal diffuser
Light Source	High efficacy COB LED with lifetime L80B50 > 50,000h
Driver	Constant current output, Pf>0.90
Supply Voltage	220-240V/50-60Hz
Ambient Temperature	-20C°/+40C°

Color Options  Ral 9006

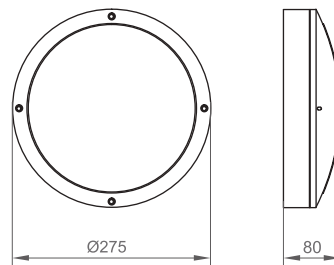
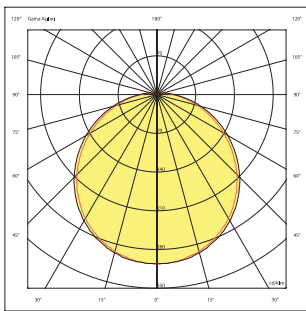

Order Code	W	Lm	CCT	CRI	Kg
09112.27.30.010	14	1000	3000	Ra>80	1,3
09112.27.30.016	19	1600	3000	Ra>80	1,3
09112.27.40.011	14	1100	4000	Ra>80	1,3
09112.27.40.017	19	1700	4000	Ra>80	1,3

EDGE

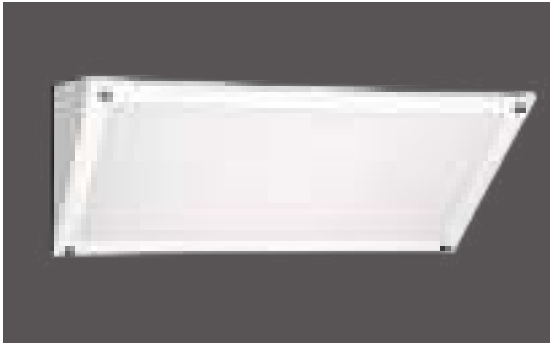

Housing	Electrostatic coated steel sheet
Diffuser	Highly transmissive opal diffuser
Light Source	High efficacy COB LED with lifetime L80B50 > 50,000h
Driver	Constant current output, Pf>0.90
Supply Voltage	220-240V/50-60Hz
Ambient Temperature	-20C°/+40C°
Ambient Temperature	Dali 3 hour emergency lighting kit

Color Options

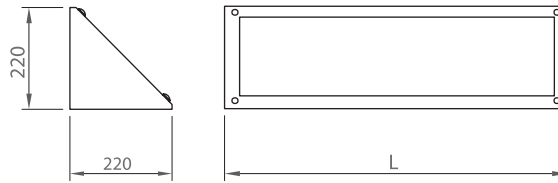
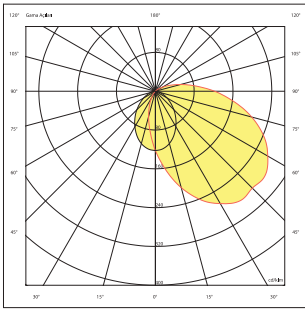
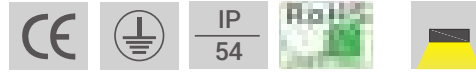

Order Code	W	Lm	CCT	CRI	L (mm)	Kg
06159.22.30.017	20	1700	3000	Ra>80	220x200	-
06159.22.30.034	40	3400	3000	Ra>80	220x430	-
06159.22.30.048	60	4800	3000	Ra>80	220x850	-
06159.22.40.018	20	1800	4000	Ra>80	220x200	-
06159.22.40.035	40	3500	4000	Ra>80	220x430	-
06159.22.40.050	60	5000	4000	Ra>80	220x850	-

SUNNY



Housing	Electrostatic coated aluminum
Optics	Highly transmissive acrylic optic lens
Glass	Tempered and clear
Light Source	MacAdam Step-3 high efficacy High Power LED with lifetime L80B50 > 50,000h
Driver	Constant current output, Pf>0.90
Supply Voltage	220-240V/50-60Hz
Lens Options	10°-25°-45°-120°
Options	54 W-100 W -20C/+50C 150W -20C/+40C

Color Options



Ral 9005

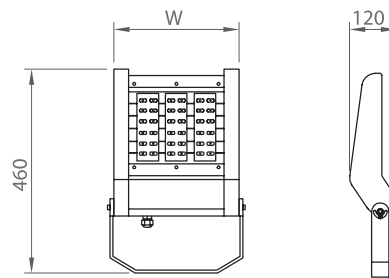
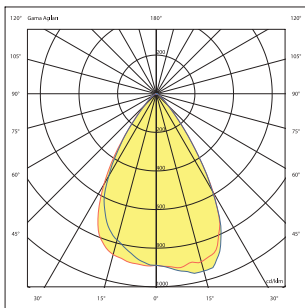

Order Code	W	Lm	CCT	CRI	W x L	Kg
09290.24.40.061	54	6100	4000	Ra>80	255x480	7,3
09290.24.40.077	76	7700	4000	Ra>80	255x480	7,3
09290.34.40.111	100	11100	4000	Ra>80	305x480	7,5
09290.44.40.162	151	16150	4000	Ra>80	405x480	7,9

SUNNY-R



Color Options  Ral 9005

Housing	Electrostatic coated aluminum
Optics	Highly transmissive assymmetric acrylic lens
Glass	Tempered and clear
Light Source	MacAdam Step-3 high efficacy Mid Power LED with lifetime L80B50 > 50,000h
Driver	Constant current output, Pf>0.90
Supply Voltage	220-240V/50-60Hz
Options	DALI 3000K-5000K

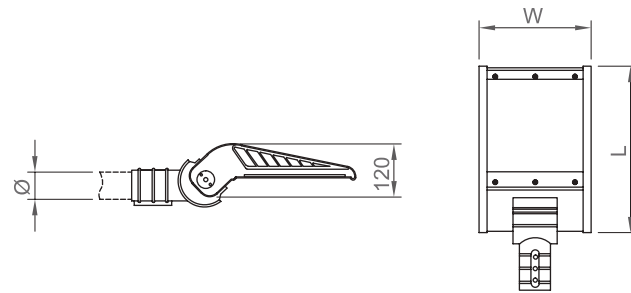
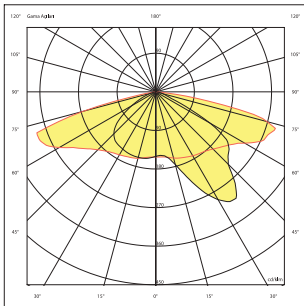

Order Code	W	Lm	CCT	CRI	W x L	Kg
09291.15.40.036	30	3600	4000	Ra>80	160x500	7,3
09291.25.40.077	76	7700	4000	Ra>80	255x500	7,3
09291.35.40.115	107	11100	4000	Ra>80	305x500	7,5
09291.45.40.162	151	16150	4000	Ra>80	405x500	7,9

ANEMON



Color Options

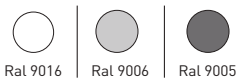

Housing	Matte anodized aluminum
Optics	Highly transmissive optic lens
Glass	Tempered and clear
Light Source	MacAdam Step-3 high efficacy High Power LED with lifetime L80B50 > 50,000h
Driver	Constant current output, Pf>0.90
Supply Voltage	220-240V/50-60Hz
Ambient Temperature	-20C°/+50C°
Lens Options	10°-25°-45°-120°
Options	DALI 5000K Red-Green-Blue-Amber

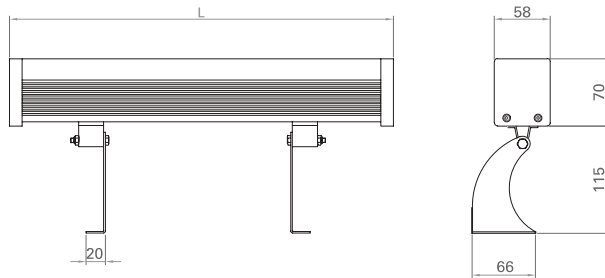
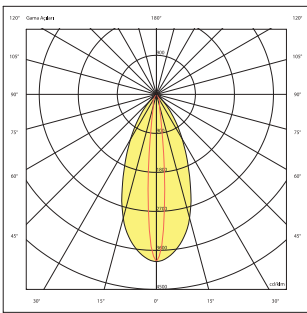

Order Code	W	Lm	CCT	CRI	L	Kg
05255.34.30.015	14	1540	3000	Ra>80	340	1,5
05255.65.30.030	29	3120	3000	Ra>80	650	2,9
05255.97.30.040	43	4730	3000	Ra>80	970	4,4
05255.12.30.060	55	6050	3000	Ra>80	1250	5,6
05255.34.40.016	14	1680	4000	Ra>80	340	1,5
05255.65.40.030	29	3480	4000	Ra>80	650	2,9
05255.97.40.040	43	5160	4000	Ra>80	970	4,4
05255.12.40.060	55	6600	4000	Ra>80	1250	5,6