

PRODUCT LIST

VENTILATION

Corporate

Havalandırma Grup has been maintaining its service and quality standards at the maximum level for 15 years. Passenger in the industry, We offer the opportunity to find every product sought quickly and easily with our rich product range.

Havalandırma Grup started in 2007 in Ankara with the sale of Ventilation and Air Ducts accessories and this. It has developed steadily until today.

Havalandırma Grup, Operating space first started by selling Air Channel Accessories and Air Channel Equipment Following an expanding customer portfolio, the group expanded its workspace in 2012 with products such as Ventilation Devices, Ventilation Systems, Elastomeric Rubber Isolation and Isolation Materials, Flexible Air Channels, Geographic Air Channels, Prismatic Air Channels, Air Grills, Air Dampers, Air Louvers, Anemostad, etc. It has also contributed to the country's national income by selling out of Ankara, as well as in Russia, Azerbaijan, Iraq, Kazakhstan, Kuwait, Uzbekistan, with the growth of its customer portfolio.

Our company has always kept the understanding of "Service and Quality First" in the foreground. Increasing product quality, capacity. The targets of raising the technology have brought along the technological investments and Ventilation Devices and Air Duct Accessories in 2013 as a result of the rapidly growing construction activities in the country. In the same years, the first companies that come to mind in the sector are Isidem, Blauberg Fan, Aksa Motor Fan. It has increased its product and brand range by making agreements with companies.

Havalandırma Grup is today in the field of supplying materials in all kinds of Mechanical Installation and ventilation sectors. provides services and can respond to all kinds of special orders and special projects.

Our company is located in Ankara with its expert staff, 1000 square meters of sales area and 3000 square meters of warehouse areas. It continues its activities in İvedik Organize Sanayi Bölgesi.

Our Quality Policy

By evaluating the technology and living conditions required by our age in the best way and providing customer satisfaction to bring our company to a reliable, stable and sector-leading position in Ankara and Turkey. In the direction of the development of our employees and all the technological equipment we use, at the maximum level to invest. Internationally accepted ISO 9001 quality system, CE-TSE, Domestic Production Certificate and while increasing our service quality by applying quality standards to our management with Domestic Goods certificates, in an endless harmony with our customers with our technical consultancy and after-sales services. To be in constant cooperation with the supplier companies in mutual trust. Human the determination to work, motivation development and belonging by making the best use of the resources provide the feeling. The service provided is subject to international standards related to the law, the customer ensure compliance with their expectations and needs.

Evaluating all activities as a process, planning, implementing and control and continuously improve its performance. Competitive in world markets Contributing to the Turkish economy by using our structure





AIR CHANGE PER HOUR CALCULATION

HOURLY AIR CHANGE NUMBER METHOD

It removes the volume (width x length x height) of the place to be ventilated. According to the purpose of use, the air change per hour (Table: 1) is multiplied by air and the ventilation flow for that place is found. Accordingly, the air requirement;

$$Q = H_d V_m \text{ (m}^3\text{/h)}$$

H_d : Number of Air Changes (times/hour = 1/h = h⁻¹) (Table:1)

V_m : Total Volume of the Environment (m³)

Hourly Air Changes of Different Places
Table-1

PLACES NAME	AIR CHANGES NUMBER	PLACES NAME	AIR CHANGES NUMBER
Barns	8-15	Bedrooms	2-4
Operating Room	25-40	Underground Laundries	30-40
Intensive Care Unit	9-15	Paint Workshops	30-60
Analysis Labs	7-8	Machining Workshops	6-10
Bathrooms	6-10	Banks	2-4
Printing Houses	10-15	Hotel Bars	4-6
Waiting Room	7-8	Laundries	20-30
Warehouse	7-8	Bakery Ovens	20-30
Storager	5-10	Offices	4-6
Rest Room	7-8	Cafeteria and Cafeteria Bars	10-12
Joiner	10	Cargo Holds	6-10
Shower Areas	15-20	Ship Holds	10-20
Shower Cabins	15-20	Galvanic Baths	25
Shops	6-15	Night clubs	18
Steakhouses	20-30	Dressing Room	8-12
Home Toilets	10-15	Workplaces	12
Copiers	12	Car services	20-40
Furnace Workshops (Melting and Heat Treatment Furnace)	30-60	Cellars	10
Repair-Shop	15-30	Clinics	5
Theaters	6-8	Conference Rooms	10
Public Toilets	10-15	Hairdressers	10-15
Veterinary Clinics	10	dry Cleaners	30-40
Dormitories	5	Libraries	5

AIR CHANGE PER HOUR CALCULATION

Hourly Air Changes of Different Places
Table-1 Continued

PLACES NAME	AIR CHANGES NUMBER	PLACES NAME	AIR CHANGES NUMBER
Carpenter	10	Factories	6-10
Medical Offices	2-4	Foundries	20-30
Motels	10-15	Fruit Holds on Ships	20-30
Museums	5	Garages	6-8
Offices	6-7	Meeting Halls	4-6
Schools	5-7	Hospitals	4-6
Living Rooms	3-6	Laboratories	4-6
Pet Shops	15-30	WC	10-15
Pizza Shops	20-40	Swimming Pool	20-30
Pubs	8-14	Poultry Houses	6-10
Restaurants	8-15	Residential Areas	1-2
Restaurant Kitchens	25-35	Restaurants	6-10
Self Services	10-20	Pool Halls	6-8
Serums	4-10	Boiler Rooms	20-30
Sports Equipment	8-15	Classes	2-3
Supermarkets	5-10	Club Halls	8-10
Tanneries	10	Dance Halls	6-8
Canteens	4-6	Engine Rooms	20-30
Dark Room	10-15	Lounges on Ships	10-20
Mushroom Growing Areas	10-20	Paint Shop	20-30
School Kitchens	15-20	Theaters	10-15
Home Kitchens	10-15	Cinemas	10-15

FIRE SMOKE EVACUATION CALCULATION

JETFAN SMOKE EVACUATION SYSTEM

In multi-storey car parks, the capacity calculation should be made by assuming that the fire will occur on the floor with the largest volume.

Smoke evacuation capacity;

“10 air changes/hour”

or

“heat and smoke control system”

how it is calculated.

SYSTEM WITH AIR CHANGE

According to the Turkish Fire Protection Regulation, it is obligatory to discharge smoke according to at least 10 air changes in parking garages larger than 2000 m².

With the 10 air exchange method, the smoke is diluted, but it covers the entire fire area. It is preferred that the fire area does not exceed 5000 m². Each fire zone must have at least one smoke evacuation chimney.

According to BS 7346-7 :

This system does not aim to protect any area from smoke in the parking lot. It aims to dilute the smoke, reduce its temperature and assist escape.

HEAT-SMOKE CONTROL SYSTEM

Accordin to BS 7346-7 :

The fire zone should be at most 2000 m². The smoke is not allowed to go out of the area. The fire brigade should be able to approach the fire point up to 10m from the fresh air direction.

It should be seen in the CFD study that the smoke does not pass to other regions.

In order for the smoke to be kept in an area of 2000 m², the air velocity in the section should be 0.5 - 1.0 m/s without the effect of the jet fan.

For fire zone 40 m width, 50 m depth and 3 m height:

$$40\text{m} \times 3\text{m} \times 0,5\text{m/s} = 60\text{m}^3/\text{s} \text{ (216.000 m}^3/\text{h)}$$

$$40\text{m} \times 50\text{m} \times 3\text{m} \times 10 \text{ Change} = 60.000\text{m}^3/\text{h}$$

FIRE SMOKE EVACUATION CALCULATION

$$V = \frac{M(T_s + 273)}{r(T_o + 273)} \times 3600$$

V: Smoke Volume (m³/h) T_s: Smoke Temperature at Fire Point (°C)
 T_o: Ambient Temperature (°C) r: Density of air (1,2 kg/m³@20 °C)

$$M = 0,19 \times P \times Y^{1,5}$$

M: Smoke Mass (kg/s) P: Around the Fire (m)

Y: Height of smoke layer from ground

$$T_s = \left(\frac{Q}{M}\right) + T_o$$

Q : Fire Thermal Load (kW/m²)

Fire Data	With Sprinklers In the Parking	Without Sprinklers In the Parking
Fire Thermal Load	2m x 5m	5m x 5m
Ambient Temperature Around the Fire	14 m	20 m
	4 MW	8 MW

Q	Fire Thermal Load	4	MW
T _a	Ambient temperature	20	°C
P	Around the Fire	14	m
Y	Smoke Layer Height	1,8	m
M	Smoke Mass	6,42	kg/s
T _s	Smoke Temperature	643	°C
V	Smoke Volume	60,129	m ³ /h

SITE DESIGN CRITERIA

According to BS 7346-7 :

Smoke evacuation chimney of each fire zone should be separate. Air velocity **should not exceed**

5m/s on escape routes and ramps.

The air velocity at the fresh air entry points

should not exceed 2m/s to avoid smoke circulation .

The amount of air activated by the Jet Fans should be higher than the amount of exhausted air. As soon as the fire signal comes, the main fans should be activated at full capacity, the jet fans should be activated with a delay to allow escape.

The amount of fresh air intake must be ensured. (70% of the exhaust amount)

The Fire Zone must remain at negative pressure.

The exhaust direction should be determined by considering the escape points.

It should be ensured that the sprinkles heads are not close to the jet fan nozzles.

In multi-storey car parks, there should be motorized dampers at the shaft entrances.

There should be a motorized damper on the fan to prevent air escape from the non-operating fan.

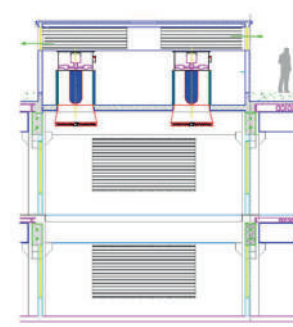

JETFAN's are named according to their propulsion;

$$\text{Impulse Force(N)} : V \times Q \times \rho$$

V: Air Velocity (m/s)
 Q: Air Flow Rate (m³/s)
 ρ: Air Density (kg/m³)

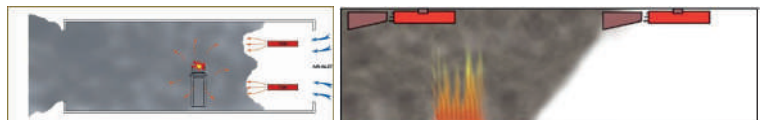

Impulse force	Parallel Distance	Series Distance
30 N	8-10 m	15 - 20 m
50 N	15 m	35 - 40 m
80 N	15 m	55 - 60 m
100 N	15 - 17 m	70 - 80 m

Jet fan impact distance determined by CFD

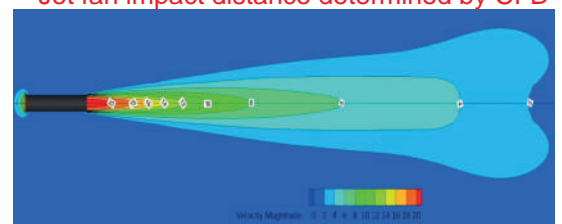

SHELTER VENTILATION CALCULATE

SHELTER VENTILATION

Ventilation Regardless of the type of shelter, mechanical ventilation is mandatory

Duty of Ventilation Installation

It is the sending of sufficient and clean air to the shelter under suitable conditions for people who have to shelter with room conditions for protection.

Ambient conditions

By providing adequate air exchange To prevent the entry of radiated, biological and chemical dusts and particles;

O_2 Level > %19

$$P_i - P_d = \Delta p = 50 \text{ Pa}$$

CO_2 Level < %2

it should be.

The pressure difference must be maintained.

Cleaning of Shelter Air The Ventilation System

The ventilation system should be arranged in a way to protect and operate in normal condition.

The outside air in normal condition is only taken inside by passing through the G4 coarse filter.

In Protection Times

Air taken from outside; G4 is passed through a filtering system such as a coarse, nuclear type hepa, activated carbon filter or sandbox and given to the shelter.

Air is not heated/cooled/humidified during protection times.

The first position of the protection position is the closed position to the outside atmosphere, and the air inside the shelter is circulated, filtered and reintroduced after cleaning.

The second position of the protection state is the situation where the outside air can be filtered and cleaned, and the minimum amount of air is taken from the outside.

The air cleaned in NBC Filters is mixed with the circulating air and given into the shelter. The filtration system creates positive pressure inside the shelter, preventing toxic agents from entering.

If the risk of fire is high in the area where the shelter is located, the sandbox system must be used first.

During the protection times for the ventilation of the shelter, the air flow rates required for one person are taken.

Flow capacity values are minimum values and any additional measures to increase air quality can be used in the design.

Shelter Capacity	Protection Ventilation	High Fire Hazard	LOW AND MEDIUM FIRE HAZARD
0-50 Up to Person	1.8 m ³ /h - Person	Sand Filter, G4 Dust Filter, Active Carbon Filter	G4 Dust Filter, Radioactive Filter and Active Carbon Filter
51-150 Up to Person	3m ³ /h - Person	Sand Filter, G4 Dust Filter, Active Carbon Filter	G4 Dust Filter, Radioactive Filter and Active Carbon Filter
150 More than People	4.5 m ³ /h - Person	Sand Filter, G4 Dust Filter, Active Carbon Filter	G4 Dust Filter, Radioactive Filter and Active Carbon Filter

SHELTER VENTILATION CALCULATE

The duct design, the number of culverts and their placement are arranged by the mechanical installation project designer.

This regulation TS3419 "Ventilation and Air Conditioning Facilities-Design Rules" and TS3420 "Air Conditioning and Air Conditioning Facilities Placement Rules" It is made taking into account the standards.

Air Distribution

Supply and outlet openings should be placed in accordance with the geometric shape of the volume desired to be ventilated, in a way that the supply air will sweep all the air, provide a breeze-free and effective ventilation in the volume, and will not disrupt the architecture of the building. Therefore, vertical surfaces close to the ceiling or ceiling, wall should be preferred.

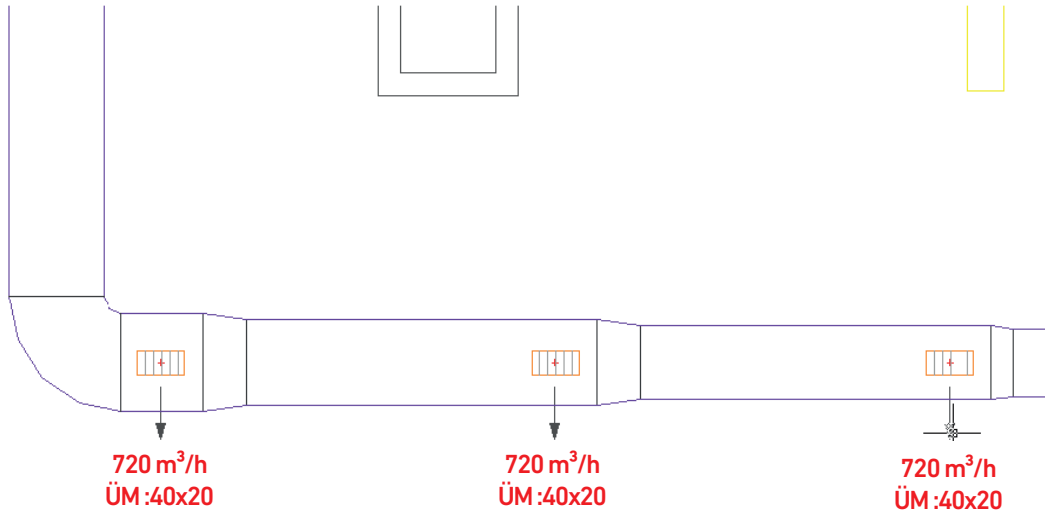

Duct Material Properties

Ventilation ducts installed for mechanical ventilation must be made of steel, aluminum and similar materials
Ducts to be used in all mechanical ventilation systems must be connected with sufficient number of suspension elements.
The duct lining material must be at least of hardly flammable material

Plant Material Properties

Panels must be double-walled aluminum, steel or galvanized
In order to be protected from the harmful effects of (X) rays, the inside of the cell should be covered with 1.2 mm lead plate.
Fresh air must pass through the lead eliminator.
Cells must be extremely rigid and impermeable.
Fans that produce high pressure should be preferred in order to overcome the pressure inside the device and transfer the air.

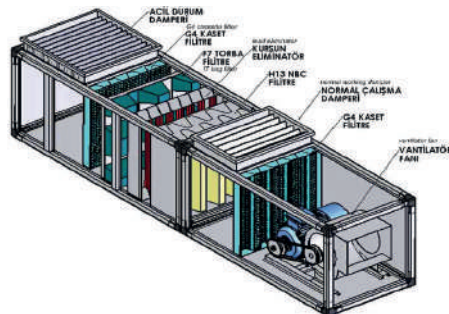

VENTILATION FANS AND SYSTEMS

point



VENTILATION FANS AND SYSTEMS

ROUND DUCT TYPE FAN

YKF



MODELS	FLOW (m ³ /h)	POWER (W)	VOLTAGE (V)	CURRENT (A)	VELOCITY (rpm)	FREQUENCY (Hz)	VOICE (dbA)
P-YKF 100	380	67	230	0,35	2300	50	40
P-YKF 125	540	70	230	0,38	2330	50	41
P-YKF 150	650	73	230	0,40	2400	50	44
P-YKF 200 A	780	95	230	0,57	1400	50	46
P-YKF 200 B	1000	103	230	0,66	2600	50	49
P-YKF 250 A	1100	145	230	0,71	2500	50	49
P-YKF 250 B	1200	165	230	0,85	2700	50	54
P-YKF 315 A	1550	180	230	1,2	2400	50	52
P-YKF 315 B	1900	195	230	1,3	2500	50	56



RECTANGULAR DUCT TYPE FAN

KF

With External Motor



MODELS	FLOW (m ³ /h)	POWER (kW)	VOLTAGE (V)	CURRENT (A)	VELOCITY (rpm)	FREQUENCY (Hz)	VOICE (dbA)
P-KF 30-15	470	0.09	230	0.42	2600	50	45
P-KF 40-20 A	960	0.16	230	0.68	2600	50	52
P-KF 40-20 B	1160	0.18	230	0.80	2700	50	56
P-KF 50-25	1620	0.18	230	0.80	2700	50	54
P-KF 60-30	1860	0.29	230	1.50	2500	50	50
P-KF 60-35 A	2750	0.21	230	1	1400	50	54
P-KF 60-35 B	3350	0.26	230	1.20	1350	50	58
P-KF 70-40 A	4400	0.43	230	1.50	1380	50	58
P-KF 70-40 B	5850	0.80	230	3.50	1350	50	60
P-KF 80-50	7540	1.10	230	2.50	1400	50	64
P-KF 100-50	9650	1.50	230	2.60	1400	50	66



RECTANGULAR DUCT TYPE FAN

DKF

With Internal Motor



MODELS	FLOW (m ³ /h)	POWER (kW)	VOLTAGE (V)	CURRENT (A)	VELOCITY (rpm)	FREQUENCY (Hz)	VOICE (dbA)
P-DKF 315 M	2200	0.25	230	2	1500	50	70
P-DKF 355 M	3100	0.25	230	2	1500	50	75
P-DKF 400 M	4200	0.37	230	3.20	1500	50	79
P-DKF 450 M	5500	0.55	230	4.20	1500	50	82
P-DKF 500 M	8100	1.1	230	7.10	1500	50	85
P-DKF 560 M	10500	2.2	230	13.40	1500	50	90
P-DKF 315 T	2200	0.25	380	0.80	1500	50	97
P-DKF 355 T	3100	0.25	380	0.80	1500	50	97
P-DKF 400 T	4200	0.37	380	1.15	1500	50	97
P-DKF 450 T	5500	0.55	380	1.60	1500	50	97
P-DKF 500 T	8100	1.10	380	2.60	1500	50	97
P-DKF 560 T	10500	2.2	380	5	1500	50	97



VENTILATION FANS AND SYSTEMS

RECTANGULAR DUCT TYPE FAN

DKF-EX
External Motor
Ex-Proof



MODELS	FLOW (m ³ /h)	POWER (kW)	VOLTAGE (V)	CURRENT (A)	VELOCITY (rpm)	FREQUENCY (Hz)	VOICE (dbA)
P-DKF EX 315	2200	0.25	380	0.8	1500	50	70
P-DKF EX 355	3100	0.25	380	0.8	1500	50	75
P-DKF EX 400	4200	0.37	380	1.15	1500	50	79
P-DKF EX 450	5500	0.55	380	1.60	1500	50	82
P-DKF EX 500	8100	1.1	380	2.70	1500	50	85
P-DKF EX 560	10500	2.2	380	3.60	1500	50	85

RECTANGULAR DUCT TYPE FAN

KF-EC
External EC Motor



MODELS	FLOW (m ³ /h)	POWER (W)	VOLTAGE (V)	CURRENT (A)	VELOCITY (rpm)	FREQUENCY (Hz)	VOICE (dbA)
P-KF-EC 30-15	565	97	230	0,73	3300	50	44
P-KF-EC 40-20 A	810	91	230	0,69	2470	50	43
P-KF-EC 40-20 B	1190	192	230	1,43	3010	50	47
P-KF-EC 50-25	1590	252	230	1,85	2500	50	45
P-KF-EC 60-30	2545	326	230	2,45	2000	50	48
P-KF-EC 60-35 A	2815	361	230	2,62	2000	50	49
P-KF-EC 60-35 B	4290	1308	230	2,35	3160	50	55
P-KF-EC 70-40 A	5710	795	230	3,48	1400	50	53
P-KF-EC 70-40 B	6810	2748	230	2,80	2530	50	57
P-KF-EC 80-50	8395	2025	380	2,01	1470	50	60
P-KF-EC 100-50	11190	3429	380	5,00	1800	50	66

WITH EC MOTOR FANS

REDUCING ENERGY CONSUMPTION

WE SHED LIGHT ON THE FUTURE OF OUR WORLD



VENTILATION FANS AND SYSTEMS

RADIAL ROOF TYPE FAN-HORIZONTAL THROW

CF

With Internal Motor



MODELS	FLOW (m ³ /h)	POWER (W)	VOLTAGE (V)	CURRENT (A)	VELOCITY (rpm)	FREQUENCY (Hz)	VOICE (dbA)
P-CF 180	480	0.09	230	0.42	2600	50	48
P-CF 225	910	0.16	230	0.68	2600	50	49
P-CF 250	1250	0.18	230	0.80	2700	50	51
P-CF 280	2000	0.29	230	1.50	2500	50	46
P-CF 355	2930	0.21	230	1.00	1400	50	45
P-CF 400	4120	0.26	230	1.20	1350	50	50
P-CF 450	5350	0.80	230	3.50	1350	50	51
P-CF 500	7650	1.50	380	2.60	1400	50	55
P-CF 560	9890	2.50	380	4.50	1340	50	65

RADIAL ROOF TYPE FAN-VERTICAL THROW

CF-V

With Internal Motor



MODELS	FLOW (m ³ /h)	POWER (kW)	VOLTAGE (V)	CURRENT (A)	VELOCITY (rpm)	FREQUENCY (Hz)	VOICE (dbA)
P-CFV 225	910	0,09	230	0,59	2750	50	49
P-CFV 280	2000	0,15	230	0,85	1400	50	46
P-CFV 355	2930	0,22	230	1,16	1400	50	45
P-CFV 400	4120	0,33	230	1,63	1400	50	50
P-CFV 450	5350	0,45	230	2,16	1400	50	51
P-CFV 500	7650	0,86	230	2,46	1400	50	55
P-CFV 560	9890	1,48	230	4,09	1400	50	65

RADIAL ROOF TYPE FAN-VERTICAL THROW

DCF-V

With External Motor



MODELS	FLOW (m ³ /h)	POWER (kW)	VOLTAGE (V)	CURRENT (A)	VELOCITY (rpm)	FREQUENCY (Hz)	VOICE (dbA)
P-CFV 225	910	0,09	230	0,59	2750	50	49
P-CFV 280	2000	0,15	230	0,85	1400	50	46
P-CFV 355	2930	0,22	230	1,16	1400	50	45
P-CFV 400	4120	0,33	230	1,63	1400	50	50
P-CFV 450	5350	0,45	230	2,16	1400	50	51
P-CFV 500	7650	0,86	230	2,46	1400	50	55
P-CFV 560	9890	1,48	230	4,09	1400	50	65



VENTILATION FANS AND SYSTEMS

RADIAL ROOF TYPE FAN-HORIZONTAL THROW

DCF

With External Motor



MODELS	FLOW (m ³ /h)	POWER (Kw)	VOLTAGE (V)	CURRENT (A)	VELOCITY (rpm)	FREQUENCY (Hz)	VOICE (dbA)
P-DCF 280 M	1000	0.25	230	2	1500	50	53
P-DCF 315 M	1950	0.25	230	2	1500	50	53
P-DCF 355 M	2900	0.25	230	2.00	1500	50	55
P-DCF 400 M	4000	0.37	230	3.20	1500	50	60
P-DCF 450 M	5550	0.55	230	4.20	1500	50	62
P-DCF 500 M	8400	1.1	230	7.10	1500	50	64
P-DCF 560 M	10800	2.20	230	13.40	1500	50	66
P-DCF 280 T	1000	0.25	380	0.80	1500	50	53
P-DCF 315 T	1950	0.25	380	0.80	1500	50	53
P-DCF 355 T	2900	0.25	380	0.80	1500	50	55
P-DCF 400 T	4000	0.37	380	1.15	1500	50	60
P-DCF 450 T	5550	0.55	380	1.6	1500	50	62
P-DCF 500 T	8400	1.1	380	2.6	1500	50	64
P-DCF 560 T	10800	2.2	380	5	1500	50	66



RADIAL ROOF TYPE FAN-HORIZONTAL THROW

DCF-EX

With External Motor



MODELS	FLOW (m ³ /h)	POWER (kW)	VOLTAGE (V)	CURRENT (A)	VELOCITY (rpm)	FREQUENCY (Hz)	VOICE (dbA)
P-DCF EX 280 T	1000	0,25	380	0,8	1500	50	53
P-DCF EX 315 T	1950	0,25	380	0,8	1500	50	53
P-DCF EX 355 T	2900	0,25	380	0,80	1500	50	55
P-DCF EX 400 T	4000	0,37	380	1,15	1500	50	60
P-DCF EX 450 T	5550	0,55	380	1,60	1500	50	62
P-DCF EX 500 T	8400	1,1	380	2,70	1500	50	64
P-DCF EX 560 T	10800	2,20	380	3,60	1500	50	66
P-DCF EX 630 T	13100	3,00	380	7,40	1000	50	60
P-DCF EX 710 T	15000	4,00	380	9,40	1000	50	63
P-DCF EX 800 T	17000	7,50	380	16,00	1000	50	67



RADIAL ROOF TYPE FAN-HORIZONTAL THROW (CHIMNEY AND HOOD)

DCF-M

With External Motor



MODELS	FLOW (m ³ /h)	POWER (kW)	VOLTAGE (V)	CURRENT (A)	VELOCITY (rpm)	FREQUENCY (Hz)	VOICE (dbA)
P-DCF 315-1 M	1950	0,25	230	1.80	3000	50	53

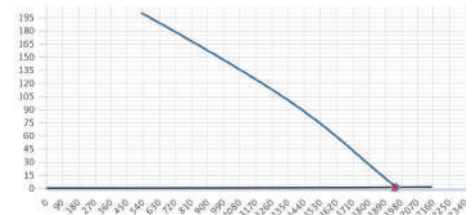
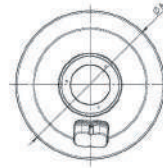
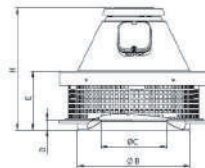

VENTILATION FANS AND SYSTEMS

RADIAL ROOF TYPE FAN-HORIZONTAL THROW

CF

With Internal Motor



MODELS	FLOW (m ³ /h)	POWER (W)	VOLTAGE (V)	CURRENT (A)	VELOCITY (rpm)	FREQUENCY (Hz)	VOICE (dbA)
P-CF 180	480	0.09	230	0.42	2600	50	48
P-CF 225	910	0.16	230	0.68	2600	50	49
P-CF 250	1250	0.18	230	0.80	2700	50	51
P-CF 280	2000	0.29	230	1.50	2500	50	46
P-CF 355	2930	0.21	230	1.00	1400	50	45
P-CF 400	4120	0.26	230	1.20	1350	50	50
P-CF 450	5350	0.80	230	3.50	1350	50	51
P-CF 500	7650	1.50	380	2.60	1400	50	55
P-CF 560	9890	2.50	380	4.50	1340	50	65

RADIAL ROOF TYPE FAN-HORIZONTAL THROW

CF-EC

With Internal Motor



MODELS	FLOW (m ³ /h)	POWER (W)	VOLTAGE (V)	CURRENT (A)	VELOCITY (rpm)	FREQUENCY (Hz)	VOICE (dbA)
P-CF 180-EC	670	0,10	230	0,77	3520	50	52
P-CF 225-EC	1290	0,10	230	0,8	2400	50	47
P-CF 250-EC	1470	0,16	230	1,29	3300	50	54
P-CF 280-EC	2330	0,18	230	1,34	2610	50	48
P-CF 355-EC	3830	0,67	230	3,36	1550	50	51
P-CF 400-EC	5380	0,53	230	3,90	1450	50	58
P-CF 450-EC	8110	1,32	230	3,27	1560	50	63
P-CF 500-EC	10900	1,35	380	2,08	1480	50	67
P-CF 560-EC	13640	2,14	380	3,83	1540	50	69

AXIAL ROOF TYPE FAN-HORIZONTAL THROW

ACF



MODELS	FLOW (m ³ /h)	POWER (kW)	VOLTAGE (V)	CURRENT (A)	VELOCITY (rpm)	FREQUENCY (Hz)	VOICE (dbA)
P-ACF 400	5500	0.25	380	0.8	1500	50	51
P-ACF 450	7000	0.37	380	1.15	1500	50	55
P-ACF 500	8500	0.55	380	1.60	1500	50	57
P-ACF 560	10500	0.55	380	1.60	1500	50	61
P-ACF 630	12500	0.75	380	2.00	1500	50	63
P-ACF 710 A	16500	1.5	380	3.50	1500	50	68
P-ACF 710 B	18500	2.20	380	5.00	1500	50	68
P-ACF 710 C	24000	3.00	380	6.60	1500	50	68
P-ACF 800	28500	3.00	380	6.60	1500	50	70
P-ACF 900	35000	4.00	380	8.40	1500	50	74
P-ACF 1000	46000	5.5	380	11.2	1500	50	77

VENTILATION FANS AND SYSTEMS

SHELTER FAN

SV
Package



G4 CASSETTE FILTER
H13 HEPA FILTER
ACTIVATED CARBON FILTER



MODELS	FLOW (m ³ /h)	POWER (kW)	VOLTAGE (V)	CURRENT (A)	VELOCITY (rpm)	FREQUENCY (Hz)	VOICE (dba)
P-SV 225	500	0,1	230	0,6	3000	50	55
P-SV 250	800	0,13	230	1,05	3000	50	60
P-SV 280	1000	0,18	230	1,10	3000	50	65
P-SV 355	2000	0,14	230	1,50	1500	50	70
P-SV 400	3000	0,38	230	3,50	1500	50	75
P-SV 450	4000	0,69	230	2,50	1500	50	80
P-SV 500	6000	1,08	230	2,60	1500	50	85
P-SV 560	8000	1,67	230	3,00	1500	50	90

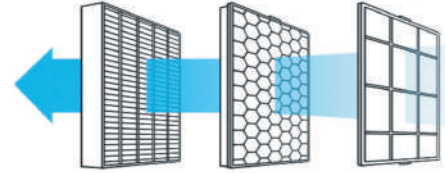

SHELTER FAN

SV-WW
Modul



G4 CASSETTE FILTER
H13 HEPA FILTER
ACTIVATED CARBON FILTER



MODELS	FLOW (m ³ /h)	POWER (kW)	VOLTAGE (V)	CURRENT (A)	VELOCITY (rpm)	FREQUENCY (Hz)	VOICE (dba)
P-SV-W 225	500	0,1	230	0,6	3000	50	55
P-SV-W 250	800	0,13	230	1,05	3000	50	60
P-SV-W 280	1000	0,18	230	1,10	3000	50	65
P-SV-W 355	2000	0,14	230	1,50	1500	50	70
P-SV-W 400	3000	0,38	230	3,50	1500	50	75
P-SV-W 450	4000	0,69	230	2,50	1500	50	80
P-SV-W 500	6000	1,08	230	2,60	1500	50	85
P-SV-W 560	8000	1,67	230	3,00	1500	50	90

SHELTER FAN

HSV
Cell Type



G4 CASSETTE FILTER
H13 HEPA FILTER
ACTIVATED CARBON FILTER



MODELS	FLOW (m ³ /h)	POWER (W)	VOLTAGE (V)	VELOCITY (rpm)	FREQUENCY (Hz)	VOICE (dba)
P-HSV-WM-1000	800-1000	0,55	380	3000	50	70
P-HSV-WM-1500	1200-1500	0,75	380	3000	50	75
P-HSV-WM-2000	1600-2000	1,1	380	3000	50	80
P-HSV-WM-2400	2100-2400	1,1	380	3000	50	85
P-HSV-WM-3000	2500-3000	1,5	380	3000	50	90
P-HSV-WM-5500	4500-5500	3,00	380	3000	50	95
P-HSV-WM-6500	5700-6500	4,00	380	3000	50	100
P-HSV-WM-7500	6600-7500	5,5	380	1500	50	110
P-HSV-WM-8500	7600-8500	5,5	380	1500	50	120

VENTILATION FANS AND SYSTEMS

HEAT RECOVERY UNIT

IGK-IP
With Heat Pump

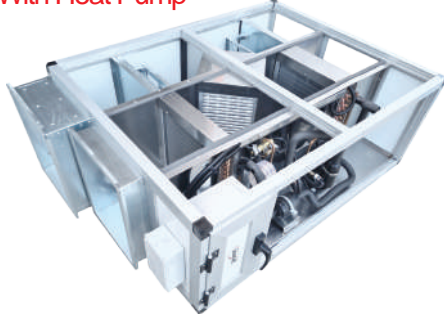

MODELS	FLOW (m ³ /h)	POWER (kW)	VOLTAGE (V)	VELOCITY (rpm)	FREQUENCY (Hz)	VOICE (dbA)	COOLING CAPACITY (kW)	HEATING CAPACITY (kW)
P-IP-IGK 1000	1000	0,21*2	230	1450	50	45	5,16	8,02
P-IP-IGK 2000	2000	0,40*2	230	1450	50	55	9,68	13,74
P-IP-IGK 3000	3000	0,80*2	230	1450	50	55	14,19	21,12
P-IP-IGK 4000	4000	0,37*2	230	1450	50	55	18,93	29,26

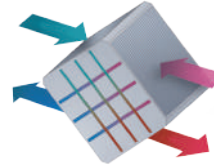
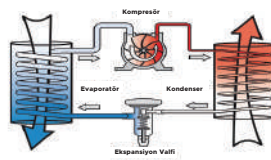

HEAT RECOVERY UNIT

IGK-ECO
Eco-Single Internal Wall



MODELS	FLOW (m ³ /h)	POWER (W)	VOLTAGE (V)	VELOCITY (rpm)	FREQUENCY (Hz)	VOICE (dbA)
P-IGK ECO 500	500	0,3	230	1450	50	45
P-IGK ECO 750	750	0,3	230	1450	50	45
P-IGK ECO 1000	1000	0,3	230	1450	50	45
P-IGK ECO 1500	1500	0,4	230	1450	50	55
P-IGK ECO 2000	2000	0,4	230	1450	50	55
P-IGK ECO 3000	3000	0,4	230	1450	50	55
P-IGK ECO 4000	4000	0,40	230	1450	50	55
P-IGK ECO 5000	5000	0,80	230	1450	50	55
P-IGK ECO 6000	6000	1,10	230	1450	50	57



HEAT RECOVERY UNIT

IGK
With Plug Fan-Double Internal Wall



MODELS	FLOW (m ³ /h)	POWER (W)	VOLTAGE (V)	VELOCITY (rpm)	FREQUENCY (Hz)	VOICE (dbA)
P-IGK 500	500	0,3	230	1450	50	45
P-IGK 750	750	0,3	230	1450	50	45
P-IGK 1000	1000	0,3	230	1450	50	45
P-IGK 1500	1500	0,4	230	1450	50	55
P-IGK 2000	2000	0,4	230	1450	50	55
P-IGK 3000	3000	0,4	230	1450	50	55
P-IGK 4000	4000	0,40	230	1450	50	55
P-IGK 5000	5000	0,80	230	1450	50	55
P-IGK 6000	6000	1,10	230	1450	50	57



VENTILATION FANS AND SYSTEMS

LOW PRESSURE SNAIL FAN

OBSF
Back Curved, Sparse Blade



MODELS	FLOW (m ³ /h)	POWER (W)	PRESSURE (pa)	VOLTAGE (V)	VELOCITY (rpm)	FREQUENCY (Hz)	VOICE (dbA)
P-OBSF 50	5000	1,1	300	380	1500	50	89
P-OBSF 75	7500	1,5	300	380	1500	50	90
P-OBSF 100	10000	2,2	300	380	1500	50	90
P-OBSF 125	12500	3	300	380	1500	50	92
P-OBSF 150	15000	4	400	380	1500	50	93
P-OBSF 175	17500	5,5	400	380	1500	50	93
P-OBSF 200	20000	7,50	700	380	1500	50	94
P-OBSF 250	25000	11,00	700	380	1500	50	95



AXIAL PRESSURIZATION FAN

BF

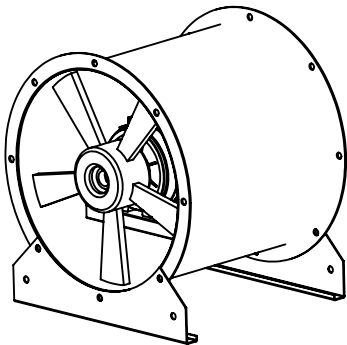

MODELS	FLOW (m ³ /h)	POWER (kW)	VOLTAGE (V)	CURRENT (A)	VELOCITY (rpm)	FREQUENCY (Hz)	VOICE (dbA)
P-BF 315 A	2350	0.18	380	0.6	1500	50	38
P-BF 315 B	11000	0.55	380	1.3	3000	50	41
P-BF 355 A	4500	0.18	380	0.60	1500	50	44
P-BF 355 B	13200	1.1	380	2.30	3000	50	47
P-BF 400 A	3100	0.25	380	0.80	1500	50	50
P-BF 400 B	17500	1.5	380	3.30	3000	50	53
P-BF 450 A	6100	0.37	380	1.15	1500	50	56
P-BF 450 B	19800	3.00	380	5.90	3000	50	59
P-BF 500 A	5000	0.55	380	1.60	1500	50	62
P-BF 500 B	22000	3.00	380	5.90	3000	50	65
P-BF 560 A	10000	0.55	380	1.6	1500	50	68
P-BF 630 A	6600	0.75	380	2	1500	50	71
P-BF 630 B	14100	1.5	380	3.5	1500	50	74
P-BF 630 C	8000	2.2	380	5	1500	50	77
P-BF 630 D	17800	3	380	6.6	1500	50	80
P-BF 710 A	27000	4	380	8.4	1500	50	83
P-BF 800 A	35000	4	380	8.4	1500	50	86
P-BF 800 B	37000	5.5	380	11.2	1500	50	89
P-BF 800 C	42000	7.5	380	15.4	1500	50	92
P-BF 900 A	44000	5.5	380	11.2	1500	50	95
P-BF 900 B	47000	7.5	380	15.4	1500	50	98
P-BF 1000 A	52000	5.5	380	11.2	1500	50	101
P-BF 1000 B	58000	7.5	380	15.4	1500	50	104
P-BF 1000 C	65000	11	380	21.3	1500	50	107
P-BF 1250 A	73000	11	380	21.3	1500	50	110
P-BF 1250 B	80000	15	380	29.8	1500	50	113
P-BF 1250 C	105000	22	380	42.5	1500	50	116
P-BF 1250 D	120000	30	380	55	1500	50	119



VENTILATION FANS AND SYSTEMS

AXIAL PRESSURIZATION FAN

CAF
Roof Type

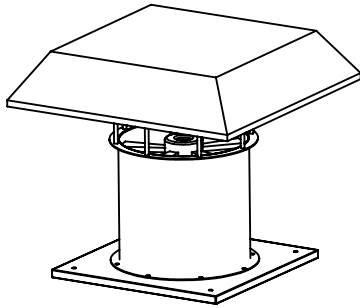

MODELS	FLOW (m ³ /h)	POWER (kW)	VOLTAGE (V)	CURRENT (A)	VELOCITY (rpm)	FREQUENCY (Hz)	VOICE (dbA)
P-CAF 315 A	2350	0,18	380	0,58	1450	50	38
P-CAF 355 A	3100	0,18	380	0,58	1450	50	41
P-CAF 400 A	5000	0,25	380	0,81	1450	50	44
P-CAF 450 A	6600	0,37	380	1,20	1450	50	47
P-CAF 500 A	8000	0,55	380	1,60	1450	50	50
P-CAF 560 A	11000	0,55	380	1,60	1450	50	53
P-CAF 630 A	13200	0,75	380	2,10	1450	50	56
P-CAF 630 B	17500	1,50	380	3,60	1450	50	59
P-CAF 630 C	19800	2,20	380	5,30	1450	50	62
P-CAF 630 D	22000	3,00	380	6,60	1450	50	65
P-CAF 315 B	4500	0,55	380	1,30	2850	50	68
P-CAF 355 B	6100	1,10	380	2,50	2850	50	71
P-CAF 400 B	10000	1,50	380	3,45	2850	50	74
P-CAF 450 B	14100	3,00	380	6,50	2850	50	77
P-CAF 500 B	17800	3,00	380	6,50	2850	50	80
P-CAF 710 A	27000	4,00	380	8,70	1450	50	83
P-CAF 800 A	35000	4,00	380	8,70	1450	50	86
P-CAF 800 B	37000	5,50	380	11,80	1450	50	89
P-CAF 800 C	42000	7,50	380	15,80	1450	50	92
P-CAF 900 A	44000	5,50	380	11,80	1450	50	95
P-CAF 900 B	47000	7,50	380	15,80	1450	50	98
P-CAF 1000 A	52000	5,50	380	11,80	1450	50	101
P-CAF 1000 B	58000	7,50	380	15,80	1450	50	104
P-CAF 1000 C	65000	11,00	380	22,50	1450	50	107
P-CAF 1250 A	73000	11,00	380	22,50	1450	50	110
P-CAF 1250 B	80000	15,00	380	30,00	1450	50	113
P-CAF 1250 C	105000	22,00	380	42,00	1450	50	116
P-CAF 1250 D	120000	30,00	380	57,00	1450	50	119

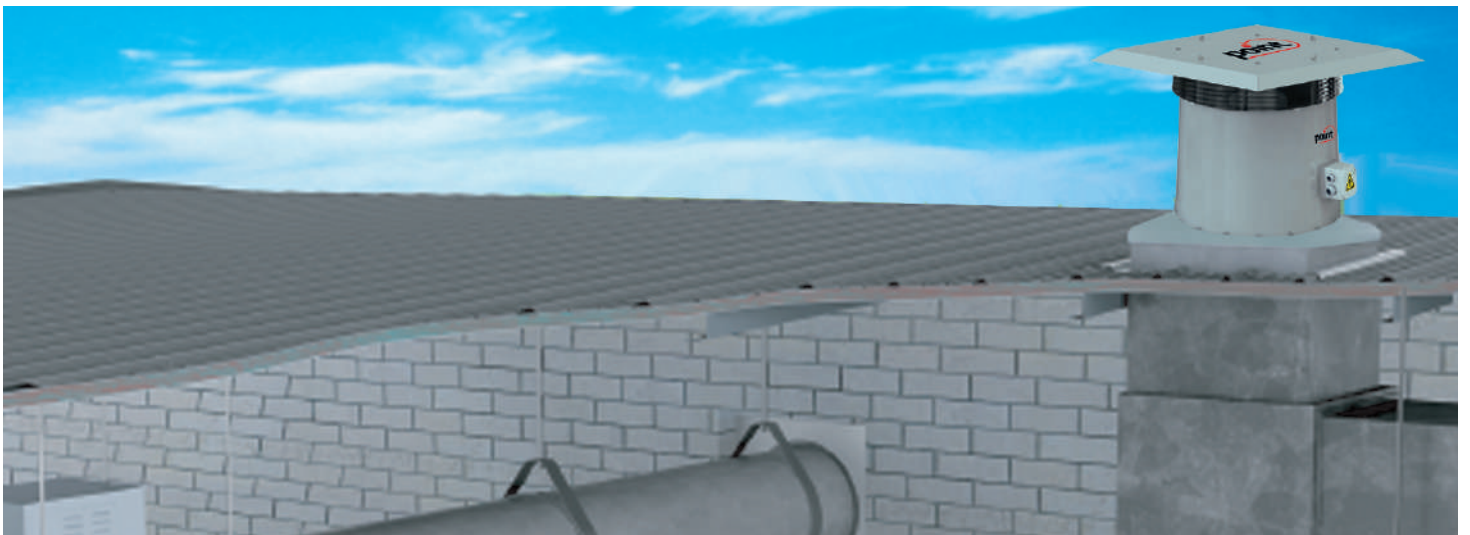

VENTILATION FANS AND SYSTEMS

AXIAL PRESSURIZATION FAN

HAF
Cell Type

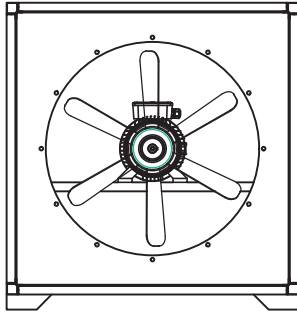

MODELS	FLOW (m ³ /h)	POWER (kW)	VOLTAGE (V)	CURRENT (A)	VELOCITY (rpm)	FREQUENCY (Hz)	VOICE (dbA)
P-HAF 315 A	2350	0,18	380	0,58	1450	50	38
P-HAF 355 A	3100	0,18	380	0,58	1450	50	41
P-HAF 400 A	5000	0,25	380	0,81	1450	50	44
P-HAF 450 A	6600	0,37	380	1,20	1450	50	47
P-HAF 500 A	8000	0,55	380	1,60	1450	50	50
P-HAF 560 A	11000	0,55	380	1,60	1450	50	53
P-HAF 630 A	13200	0,75	380	2,10	1450	50	56
P-HAF 630 B	17500	1,50	380	3,60	1450	50	59
P-HAF 630 C	19800	2,20	380	5,30	1450	50	62
P-HAF 630 D	22000	3,00	380	6,60	1450	50	65
P-HAF 315 B	4500	0,55	380	1,30	2850	50	68
P-HAF 355 B	6100	1,10	380	2,50	2850	50	71
P-HAF 400 B	10000	1,50	380	3,45	2850	50	74
P-HAF 450 B	14100	3,00	380	6,50	2850	50	77
P-HAF 500 B	17800	3,00	380	6,50	2850	50	80
P-HAF 710 A	27000	4,00	380	8,70	1450	50	83
P-HAF 800 A	35000	4,00	380	8,70	1450	50	86
P-HAF 800 B	37000	5,50	380	11,80	1450	50	89
P-HAF 800 C	42000	7,50	380	15,80	1450	50	92
P-HAF 900 A	44000	5,50	380	11,80	1450	50	95
P-HAF 900 B	47000	7,50	380	15,80	1450	50	98
P-HAF 1000 A	52000	5,50	380	11,80	1450	50	101
P-HAF 1000 B	58000	7,50	380	15,80	1450	50	104
P-HAF 1000 C	65000	11,00	380	22,50	1450	50	107
P-HAF 1250 A	73000	11,00	380	22,50	1450	50	110
P-HAF 1250 B	80000	15,00	380	30,00	1450	50	113
P-HAF 1250 C	105000	22,00	380	42,00	1450	50	116
P-HAF 1250 D	120000	30,00	380	57,00	1450	50	119



Türkiye'nin Her Yerine
Teknik Servis İmkanı



point® HAVALANDIRMA
SİSTEMLERİ

www.pointhvac.com | (0312) 394 57 69

VENTILATION FANS AND SYSTEMS

SMOKE EVACUATION FAN

DTF



F 300 2 H

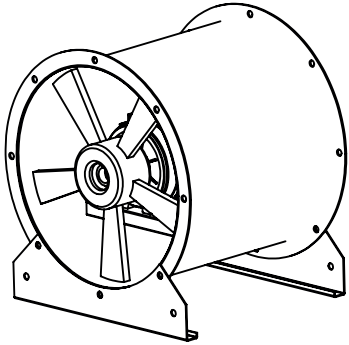

MODELS	FLOW (m ³ /h)	POWER (kW)	VOLTAGE (V)	CURRENT (A)	VELOCITY (rpm)	FREQUENCY (Hz)	VOICE (dbA)
P-DTF 355 A	5500	0.75	380	1.7	3000	50	90
P-DTF 355 B	6100	1.1	380	2.3	3000	50	90
P-DTF 400 A	10000	1.5	380	3.30	3000	50	90
P-DTF 400 B	11000	2.2	380	4.50	3000	50	90
P-DTF 450 A	13000	2.2	380	4.50	3000	50	90
P-DTF 450 B	14100	3	380	5.90	3000	50	91
P-DTF 500 A	17800	3.00	380	5.90	3000	50	91
P-DTF 560 A	20000	3.00	380	5.90	3000	50	91
P-DTF 630 A	22000	3.00	380	6.60	1500	50	92
P-DTF 630 B	22500	4.00	380	8.40	1500	50	91
P-DTF 710 A	26000	3	380	6.6	1500	50	93
P-DTF 710 B	27000	4	380	8.4	1500	50	94
P-DTF 710 C	31000	5.5	380	11.2	1500	50	95
P-DTF 800 A	31800	3	380	6.6	1500	50	96
P-DTF 800 B	35000	4	380	8.4	1500	50	97
P-DTF 800 C	37000	5.5	380	11.2	1500	50	95
P-DTF 900 A	40500	4	380	8.4	1500	50	95
P-DTF 900 B	44000	5.5	380	11.2	1500	50	95
P-DTF 900 C	47000	7.5	380	15.4	1500	50	96
P-DTF 1000 A	52000	5.5	380	11.2	1500	50	94
P-DTF 1000 B	58000	7.5	380	15.4	1500	50	97
P-DTF 1000 C	65000	11	380	21.3	1500	50	98
P-DTF 1000 D	72000	15	380	29.8	1500	50	99
P-DTF 1250 A	80000	15	380	29.8	1500	50	100
P-DTF 1250 B	88000	18.5	380	34.5	1500	50	102
P-DTF 1250 C	105000	22	380	42.5	1500	50	104
P-DTF 1250 D	120000	30	380	55	1500	50	105



VENTILATION FANS AND SYSTEMS

SMOKE EVACUATION FAN

CDTF
Roof Type

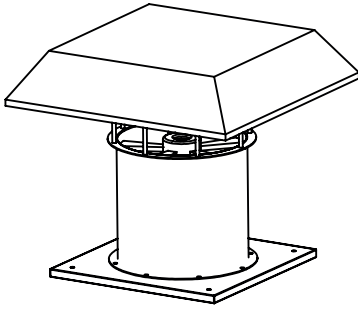

MODELS	FLOW (m ³ /h)	POWER (kW)	VOLTAGE (V)	CURRENT (A)	VELOCITY (rpm)	FREQUENCY (Hz)	VOICE (dba)
P-CDTF 355 A	5500	0,75	380	1,7	3000	50	90
P-CDTF 355 B	6100	1,1	380	2,3	3000	50	90
P-CDTF 400 A	10000	1,5	380	3,30	3000	50	90
P-CDTF 400 B	11000	2,2	380	4,50	3000	50	90
P-CDTF 450 A	13000	2,2	380	4,50	3000	50	90
P-CDTF 450 B	14100	3	380	5,90	3000	50	91
P-CDTF 500 A	17800	3,00	380	5,90	3000	50	91
P-CDTF 560 A	20000	3,00	380	5,90	3000	50	91
P-CDTF 630 A	22000	3,00	380	6,60	1500	50	92
P-CDTF 630 B	22500	4,00	380	8,40	1500	50	91
P-CDTF 710 A	26000	3	380	6,6	1500	50	93
P-CDTF 710 B	27000	4	380	8,4	1500	50	94
P-CDTF 710 C	31000	5,5	380	11,2	1500	50	95
P-CDTF 800 A	31800	3	380	6,6	1500	50	96
P-CDTF 800 B	35000	4	380	8,4	1500	50	97
P-CDTF 800 C	37000	5,5	380	11,2	1500	50	95
P-CDTF 900 A	40500	4	380	8,4	1500	50	95
P-CDTF 900 B	44000	5,5	380	11,2	1500	50	95
P-CDTF 900 C	47000	7,5	380	15,4	1500	50	96
P-CDTF 1000 A	52000	5,5	380	11,2	1500	50	94
P-CDTF 1000 B	58000	7,5	380	15,4	1500	50	97
P-CDTF 1000 C	65000	11	380	21,3	1500	50	98
P-CDTF 1000 D	72000	15	380	29,8	1500	50	99
P-CDTF 1250 A	80000	15	380	29,8	1500	50	100
P-CDTF 1250 B	88000	18,5	380	34,5	1500	50	102
P-CDTF 1250 C	105000	22	380	42,5	1500	50	104
P-CDTF 1250 D	120000	30	380	55	1500	50	105



VENTILATION FANS AND SYSTEMS

SMOKE EVACUATION FAN

HDTF
Cell Type
F 300°C /2 H

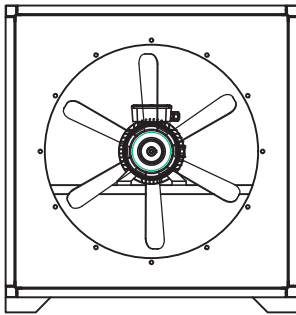

MODELS	FLOW (m ³ /h)	POWER (kW)	VOLTAGE (V)	CURRENT (A)	VELOCITY (rpm)	FREQUENCY (Hz)	VOICE (dbA)
P-HDTF 355 A	5500	0,75	380	1,7	3000	50	41
P-HDTF 355 B	6100	1,1	380	2,3	3000	50	43
P-HDTF 400 A	10000	1,5	380	3,30	3000	50	45
P-HDTF 400 B	11000	2,2	380	4,50	3000	50	47
P-HDTF 450 A	13000	2,2	380	4,50	3000	50	51
P-HDTF 450 B	14100	3	380	5,90	3000	50	53
P-HDTF 500 A	17800	3,00	380	5,90	3000	50	55
P-HDTF 560 A	20000	3,00	380	5,90	3000	50	57
P-HDTF 630 A	22000	3,00	380	5,90	1500	50	59
P-HDTF 630 B	22500	4,00	380	8,40	1500	50	61
P-HDTF 710 A	26000	3	380	6,6	1500	50	63
P-HDTF 710 B	27000	4	380	8,4	1500	50	65
P-HDTF 710 C	31000	5,5	380	11,2	1500	50	67
P-HDTF 800 A	31800	3	380	6,6	1500	50	69
P-HDTF 800 B	35000	4	380	8,4	1500	50	71
P-HDTF 800 C	37000	5,5	380	11,2	1500	50	73
P-HDTF 900 A	40500	4	380	8,4	1500	50	75
P-HDTF 900 B	44000	5,5	380	11,2	1500	50	77
P-HDTF 900 C	47000	7,5	380	15,4	1500	50	79
P-HDTF 1000 A	52000	5,5	380	11,2	1500	50	81
P-HDTF 1000 B	58000	7,5	380	15,4	1500	50	83
P-HDTF 1000 C	65000	11	380	21,3	1500	50	85
P-HDTF 1000 D	72000	15	380	29,8	1500	50	87
P-HDTF 1250 A	80000	15	380	29,8	1500	50	89
P-HDTF 1250 B	88000	18,5	380	34,5	1500	50	91
P-HDTF 1250 C	105000	22	380	42,5	1500	50	93
P-HDTF 1250 D	120000	30	380	55	1500	50	95

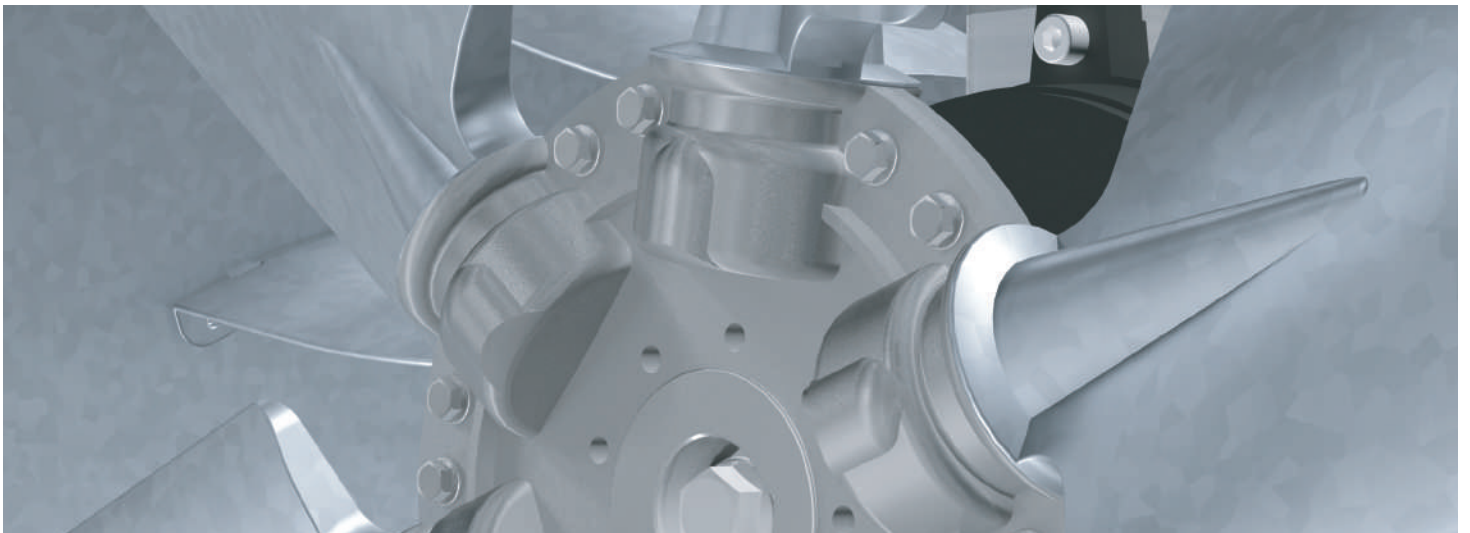

VENTILATION FANS AND SYSTEMS

AXIAL WALL TYPE FAN WITH F300

AF

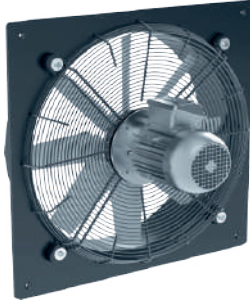

F 300 2 H 300 °C



MODELS	FLOW (m³/h)	POWER (kW)	VOLTAGE (V)	CURRENT (A)	VELOCITY (rpm)	FREQUENCY (Hz)	VOICE (dba)
P-AF 400	5000	0,25	380	0,81	1450	50	64
P-AF 450	6000	0,37	380	1,15	1450	50	65
P-AF 500	7500	0,55	380	1,60	1450	50	68
P-AF 560	10000	0,55	380	1,60	1450	50	69
P-AF 630	12000	0,75	380	1,92	1450	50	70
P-AF 710 A	16000	1,5	380	3,50	1450	50	75
P-AF 710 B	18000	2,2	380	4,90	1450	50	76
P-AF 710 C	23000	3	380	6,70	1450	50	78



AXIAL WALL TYPE FAN

AF-EX
Ex-Proof

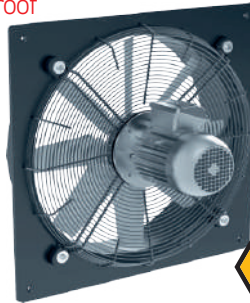

MODELS	FLOW (m³/h)	POWER (kW)	VOLTAGE (V)	CURRENT (A)	VELOCITY (rpm)	FREQUENCY (Hz)	VOICE (dba)
P-AF EX 315	2600	0,25	380	0,81	1450	50	65
P-AF EX 355	3800	0,25	380	0,81	1450	50	66
P-AF EX 400	5300	0,25	380	0,81	1450	50	64
P-AF EX 450	7500	0,37	380	1,15	1450	50	65
P-AF EX 500	9100	0,55	380	1,60	1450	50	68
P-AF EX 560	10800	0,55	380	1,60	1450	50	69
P-AF EX 630	13000	0,75	380	1,92	1450	50	70
P-AF EX 710 A	17000	1,5	380	3,50	1450	50	75
P-AF EX 710 B	20100	2,2	380	4,90	1450	50	76
P-AF EX 710 C	23500	3	380	6,70	1450	50	78



AXIAL JET FAN

AJF



F 300 2 H 55 °C



MODELS	FLOW (m³/h)	POWER (kW)	VOLTAGE (V)	IMPULSE (N)	CURRENT (A)	VELOCITY (rpm)	FREQUENCY (Hz)	VOICE (dba)
P-AJF 315	2500-5000	0,70-0,85	380	7/26	2-2,3	1500-3000	50	39-58
P-AJF 355	3500-7000	1-1,3	380	12/46	2,5-3,3	1500-3000	50	41-62
P-AJF 400	5000-10000	1,3-1,8	380	19/76	3-4,3	1500-3000	50	44-65



F 300 2 H 300 °C

MODELS	FLOW (m³/h)	POWER (kW)	VOLTAGE (V)	IMPULSE (N)	CURRENT (A)	VELOCITY (rpm)	FREQUENCY (Hz)	VOICE (dba)
P-AJF 315	2500-5000	0,25/1	380	7/26	0,70-2,2	1500-3000	50	39-58
P-AJF 355	3500-7000	0,33/1,3	380	12/46	0,90-2,8	1500-3000	50	41-62
P-AJF 400	5000-10000	0,5/2	380	19/76	1,2-4,2	1500-3000	50	44-65

F 400 400 °C

MODELS	FLOW (m³/h)	POWER (kW)	VOLTAGE (V)	IMPULSE (N)	CURRENT (A)	VELOCITY (rpm)	FREQUENCY (Hz)	VOICE (dba)
P-AJF 315	2500-5000	0,25/1	380	7/26	0,70-2,2	1500-3000	50	70
P-AJF 355	3500-7000	0,33/1,3	380	12/46	0,90-2,8	1500-3000	50	75
P-AJF 400	5000-10000	0,5/2	380	19/76	1,2-4,2	1500-3000	50	79



VENTILATION FANS AND SYSTEMS

RADIAL JET FAN

RJF



F 300°C / 2 H

MODELS	FLOW (m ³ /h)	POWER (kW)	VOLTAGE (V)	IMPULSE (N)	VELOCITY (rpm)	FREQUENCY (Hz)	VOICE (dba)
P-RJF 500	2500-5000	0,3/1,2	380	12/48	750-1500	50	55-73
P-RJF 560	3500-7000	0,55/2,2	380	18/69	750-1500	50	60-91

CELL ASPIRATOR

SH

Forward Curved



* Please specify direction number when ordering.

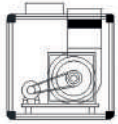

Direction 1

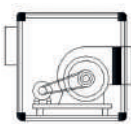

Direction 2

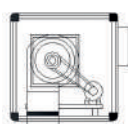

Direction 3

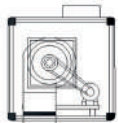

Direction 4

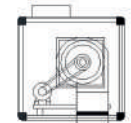

Direction 5

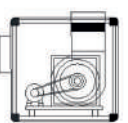

Direction 6

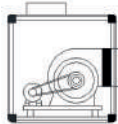

Direction 7

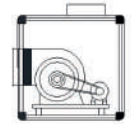

Direction 8

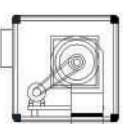

Direction 9



Direction 10

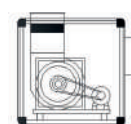

Direction 11

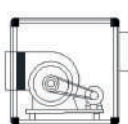

Direction 12

* Please contact for intermediate models.

MODELS	FLOW (m ³ /h)	PRESSURE (Total Static) (pa)	MODEL OF FAN	MOTOR (kW)	VELOCITY (rpm)	VOICE (dBa)
P-SH-11T	1000	300	7*7	0,25	1390	74,3
P-SH-17T	2000	500	7*7	0,75	1773	79,9
P-SH-23T	3000	500	9*9	1,1	1488	80,6
P-SH-29T	4000	500	9*9	1,5	1494	84,5
P-SH-35T	5000	500	10*10	1,5	1180	85
P-SH-41T	6000	500	12*12	2,2	1022	88,7
P-SH-47T	7000	500	12*12	2,2	999	90,4
P-SH-53T	8000	500	15*11	2,2	824	88,8
P-SH-59T	9000	500	15*15	3	854	90,5
P-SH-65T	10000	500	15*15	3	849	93,3
P-SH-71T	11000	500	18*18	3	723	94,6
P-SH-77T	12000	500	18*18	3	723	92,5
P-SH-83T	13000	500	18*18	4	717	93,3
P-SH-89T	14000	500	18*18	4	713	93,3
P-SH-92T	15000	500	450	5,5	733	93,8
P-SH-98T	16000	500	450	5,5	732	97,4
P-SH-102T	17000	500	450	5,5	734	93,3
P-SH-107T	18000	500	500	5,5	684	93,5
P-SH-111T	19000	500	500	5,5	684	95,4
P-SH-115T	20000	500	500	5,5	685	93,1
P-SH-119T	21000	500	500	7,5	687	87,1
P-SH-123T	22000	500	500	7,5	691	87,1
P-SH-127T	23000	500	560	7,5	605	87,1
P-SH-131T	24000	500	560	7,5	605	87,1
P-SH-135T	25000	500	560	7,5	606	87,1
P-SH-139T	26000	500	560	7,5	607	90
P-SH-143T	27000	500	560	7,5	609	93,6
P-SH-147T	28000	500	630	7,5	522	93,3
P-SH-151T	29000	500	630	11	520	90,8
P-SH-154T	30000	500	630	11	518	93,7
P-SH-157T	31000	500	630	11	517	91,8
P-SH-160T	32000	500	630	11	516	94
P-SH-163T	33000	500	630	11	516	91,7
P-SH-166T	34000	500	630	11	516	91,7



VENTILATION FANS AND SYSTEMS

CELL ASPIRATOR

SYH

Backward Curved Blade



MODELS	FLOW (m ³ /h)	PRESSURE (Total Static) (pa)	MODEL OF FAN	MOTOR (kW)	VELOCITY (rpm)	VOICE (dBa)
P-SYH-11T	2000	300	250	0,37	1902	77,6
P-SYH-16T	3000	500	250	1,1	2632	80,8
P-SYH-20T	4000	500	280	1,1	2296	86,7
P-SYH-24T	5000	500	280	1,5	2663	90,3
P-SYH-28T	6000	500	280	2,2	3043	90,5
P-SYH-32T	7000	500	315	2,2	2476	92,9
P-SYH-36T	8000	500	315	3	2770	94,7
P-SYH-40T	9000	500	355	3	2134	97,5
P-SYH-44T	10000	500	355	4	2358	95,4
P-SYH-48T	11000	500	355	5,5	2671	97,9
P-SYH-52T	12000	500	450	3	1519	99,7
P-SYH-56T	13000	500	400	5,5	2284	94,8
P-SYH-60T	14000	500	450	4	1650	97,2
P-SYH-64T	15000	500	450	5,5	1785	97,7
P-SYH-68T	16000	500	450	7,5	1915	94,7
P-SYH-72T	17000	500	450	7,5	1983	96,4
P-SYH-76T	18000	500	500	5,5	1508	97,1
P-SYH-80T	19000	500	500	7,5	1215	99,7
P-SYH-84T	20000	500	500	7,5	1673	94
P-SYH-88T	21000	500	500	11	1833	97,1
P-SYH-92T	22000	500	500	11	1887	97,3
P-SYH-96T	23000	500	560	7,5	1348	98,2
P-SYH-100T	24000	500	560	7,5	1437	96,3
P-SYH-104T	25000	500	560	11	1475	96,9
P-SYH-108T	26000	500	560	11	1610	99,2
P-SYH-112T	27000	500	560	11	1647	99,3
P-SYH-116T	28000	500	630	7,5	1152	99,4
P-SYH-120T	29000	500	630	7,5	1176	101
P-SYH-124T	30000	500	630	11	1291	101,2
P-SYH-128T	31000	500	630	11	1273	95,9
P-SYH-132T	32000	500	630	11	1300	96
P-SYH-136T	33000	500	630	15	1410	98,4
P-SYH-140T	34000	500	630	15	1436	98,5
P-SYH-144T	35000	500	710	11	1105	98,5
P-SYH-148T	36000	500	710	11	1035	98,6
P-SYH-152T	37000	500	710	11	1093	98,6
P-SYH-156T	38000	500	710	15	1111	96
P-SYH-160T	39000	500	710	15	1206	95,6
P-SYH-164T	40000	500	710	15	1149	96,6
P-SYH-168T	41000	500	710	15	1242	98,2
P-SYH-172T	42000	500	710	15	1206	96,6
P-SYH-176T	43000	500	710K	18,5	1278	98,8
P-SYH-180T	44000	500	710K	18,5	1297	98,9
P-SYH-184T	45000	500	710K	18,5	1315	99,1

* Please specify direction number when ordering.

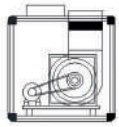

Direction 1

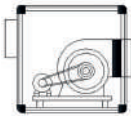

Direction 2

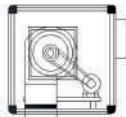

Direction 3

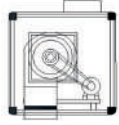

Direction 4

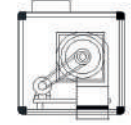

Direction 5

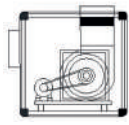

Direction 6

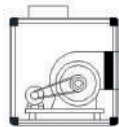

Direction 7

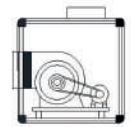

Direction 8

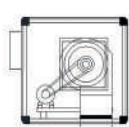

Direction 9

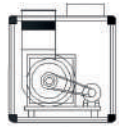

Direction 10

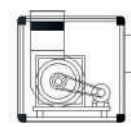

Direction 11

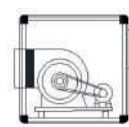

Direction 12

* Please contact for intermediate models.



VENTILATION FANS AND SYSTEMS

CELL ASPIRATOR

PH
Plug Fanlı



* Please specify direction number when ordering.

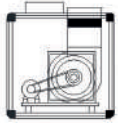

Direction 1

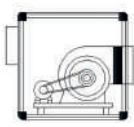

Direction 2

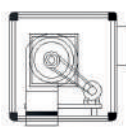

Direction 3

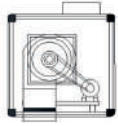

Direction 4

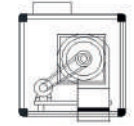

Direction 5

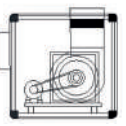

Direction 6

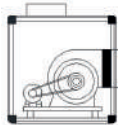

Direction 7

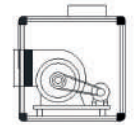

Direction 8

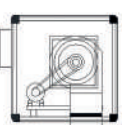

Direction 9

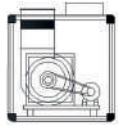

Direction 10

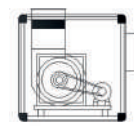

Direction 11

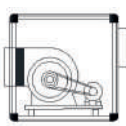

Direction 12

* Please contact for intermediate models.

MODELS	FLOW (m ³ /h)	PRESSURE (Total Static) (pa)	MODEL OF FAN	MOTOR (kW)	VELOCITY (rpm)	VOICE (dBa)
P-PH-11T	2000	300	280	0,55	2538	88
P-PH-16T	3000	500	280	1,1	3123	94
P-PH-20T	4000	500	315	1,5	2880	96
P-PH-24T	5000	500	355	2,2	2450	96
P-PH-28T	6000	500	400	2,2	2111	101
P-PH-32T	7000	500	400	3	2345	93
P-PH-36T	8000	500	450	2,2	1945	103
P-PH-40T	9000	500	450	3	2112	98
P-PH-44T	10000	500	500	3	1783	96
P-PH-48T	11000	500	500	4	1907	99
P-PH-52T	12000	500	560	4	1550	96
P-PH-56T	13000	500	560	4	1636	98
P-PH-60T	14000	500	560	5,5	1725	100
P-PH-64T	15000	500	630	5,5	1374	101
P-PH-68T	16000	500	630	5,5	1434	103
P-PH-72T	17000	500	630	5,5	1496	100
P-PH-76T	18000	500	630	5,5	1560	101
P-PH-80T	19000	500	710	5,5	1192	102
P-PH-84T	20000	500	710	5,5	1231	103
P-PH-88T	21000	500	710	7,5	1271	105
P-PH-92T	22000	500	710	7,5	1313	98
P-PH-96T	23000	500	710	7,5	1355	99
P-PH-100T	24000	500	800	7,5	1064	100
P-PH-104T	25000	500	800	7,5	1092	101
P-PH-108T	26000	500	800	7,5	1121	102
P-PH-112T	27000	500	800	7,5	1150	103
P-PH-116T	28000	500	800	11	1179	104
P-PH-120T	29000	500	800	11	1209	105
P-PH-124T	30000	500	900	11	942	106
P-PH-128T	31000	500	900	11	961	107
P-PH-132T	32000	500	900	11	981	107
P-PH-136T	33000	500	900	11	1002	108
P-PH-140T	34000	500	900	11	1022	104
P-PH-144T	35000	500	900	11	1043	105
P-PH-148T	36000	500	900	11	1064	105
P-PH-152T	37000	500	1000	11	859	106
P-PH-156T	38000	500	1000	11	873	107
P-PH-160T	39000	500	1000	11	888	107
P-PH-164T	40000	500	1000	15	903	108



VENTILATION FANS AND SYSTEMS

Cell Kitchen Hood Fan

MDF



MODELS	FLOW (m ³ /h)	POWER (kW)	VOLTAGE (V)	VELOCITY (rpm)	FREQUENCY (Hz)	VOICE (dbA)
P-MDF 3000	3000	0,25	230		50	40
P-MDF 4000	4000	0,37	230	1450	50	43
P-MDF 5000	5000	0,55	230	1450	50	47
P-MDF 7500	7500	1,1	230	1450	50	51
P-MDF 10000	10000	2,2	230	1450	50	54

* Please specify direction number when ordering.



ECOLOGY UNIT

ESF

Plant with Electrostatic Filter



MODELS	FLOW (m ³ /h)	POWER (kW)	VOLTAGE (V)	VELOCITY (rpm)	FREQUENCY (Hz)	VOICE (dbA)
P-ESF 350	3500	1,1	380	1450	50	87
P-ESF 500	5000	1,5	380	1450	50	90
P-ESF 750	7500	3	380	1450	50	94
P-ESF 1000	10000	4	380	1450	50	96
P-ESF 1500	15000	7,5	380	1450	50	98
P-ESF 2000	20000	11	380	1450	50	99



VENTILATION FANS AND SYSTEMS

AIR HANDLING UNIT

KS



* Aluminum profile carcass structure

* Integrated automation

* Drip trap separator

* Technical Services facilities

* Galvanized Sheet

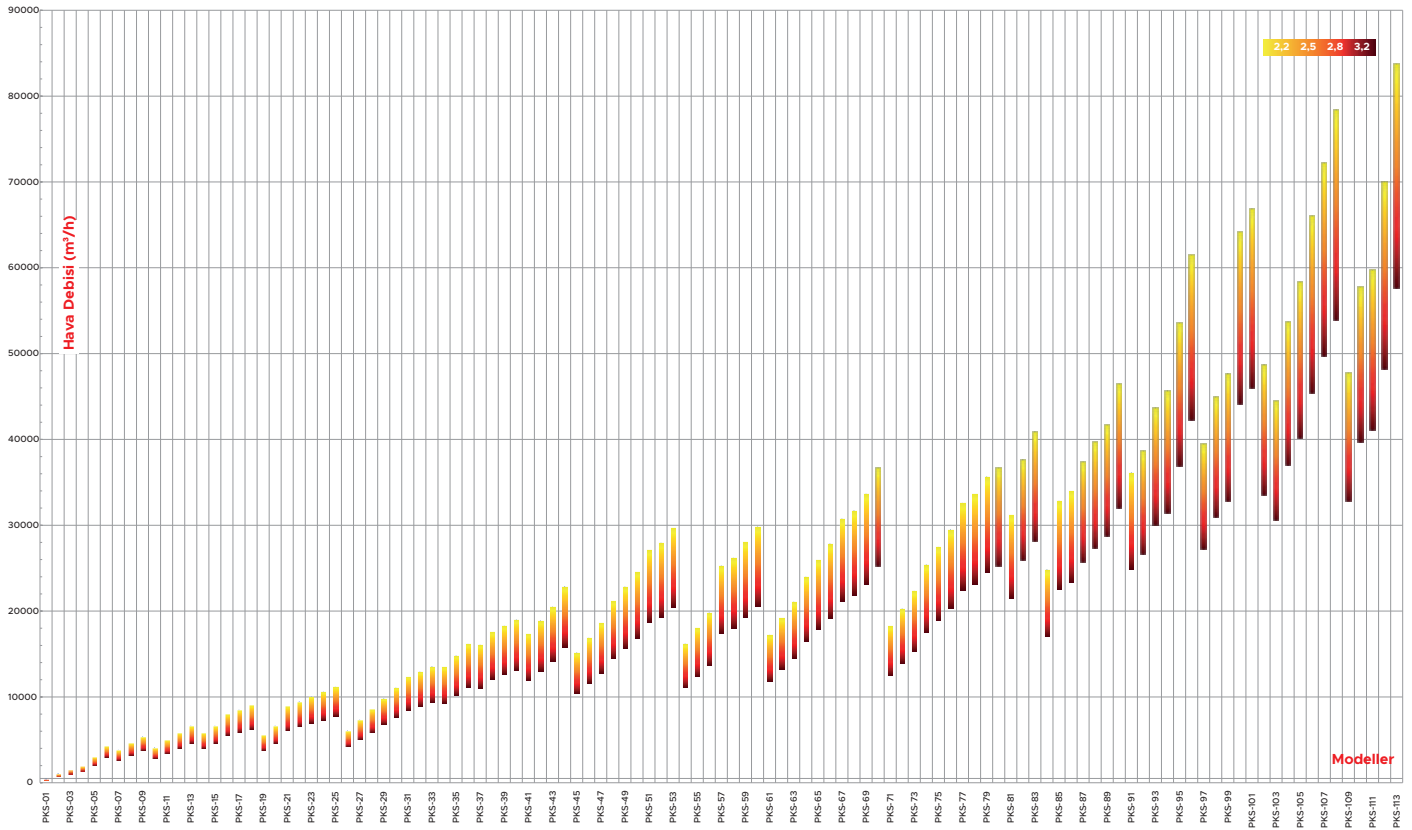
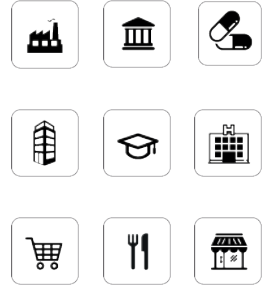

VENTILATION FANS AND SYSTEMS

DEHUMIDIFICATION PLANT

POOL



MODEL	P-POOL 040			P-POOL 060			P-POOL 080			P-POOL 100			P-POOL 120			P-POOL 150			P-POOL 180			P-POOL 210			P-POOL 250			P-POOL 315		
TIP																														
Dehumidification Capacity *	Kg/h			31,2			37,9			42,1			58,9			66,9			79,3			89,6			109,1			150,1		
Dehumidification Capacity	Kg/h			40,2			51,1			62,9			76,8			98,4			112,3			129,4			159,6			201,4		
Air Flow	m ³ /h			6,000			8,000			10,000			12,000			15,000			18,000			21,000			25,000			31,500		
Cooling Capacity ***	kW			39,8			48,2			57,8			75,9			87,4			94,5			116,2			143,2			187,7		
Water Coil Heating Capacity ****	kW			70,9			106,1			113,4			139,6			155,8			217,2			220,1			279,5			313,6		
Compressor Type	SCROLL			SCROLL			SCROLL			SCROLL			SCROLL			SCROLL			SCROLL			SCROLL			SCROLL			SCROLL		
Number of Compressors	adet			1			1			1			1			2			2			2			2			2		
External Pres. Loss of Blow Line	Pa			300			300			300			300			300			300			300			300			300		
Suction Line External Pressure Loss	Pa			300			300			300			300			300			300			300			300			300		
Ventilator Motor Power	kW			4			5,5			7,5			7,5			11			11			15			15			18,5		
Aspirator Motor Power	kW			3			4			5,5			5,5			7,5			7,5			11			11			15		
Compressor Tractive Power	kW			10,48			14,8			15,16			18,46			22,04			30,32			31,2			36,92			45,28		
Total Tractive Power	kW			17,48			24,3			28,16			31,46			40,54			48,82			57,2			62,92			78,78		

BOYUTLAR																														
L (Length)	mm			3,700			4,000			4,700			4,900			4,400			5,500			6,100			5,000			6,600		
W (Depth)	mm			1,050			1,350			1,800			1,900			2,300			2,500			2,500			2,700			2,700		
H (Height)	mm			1,700			2,100			2,400			2,700			2,700			3,000			3,100			3,100			3,100		
Weight	Kg			600			1,400			1,950			2,480			2,600			2,900			3,650			4,620			4,810		

*According to VDI 2089 **Indoor condition 30°C K.T. and for 55% RH. ***Outdoor condition -12°C K.T. and 90% rh is for 90-70°C water regime.(PR) - Plate Heat Recovery (HPR) - Heat Pipe Heat Recovery (NN) - No Heat Recovery



ACCESSORIES

ELECTRIC HEATER



EI
Duct Type



MODELS	POWER (kW)	VOLTAGE (V)	FREQUENCY (Hz)	MOUTH SIZE H (mm)	MOUTH SIZE W (mm)	LENGTH L (mm)	HEIGHT H _{max} (mm)
P-EI 3000	3	220	50	300	300	300	450
P-EI 6000	6	380	50	400	300	300	450
P-EI 9000	9	380	50	450	400	400	550
P-EI 12000	12	380	50	600	400	400	550
P-EI 15000	15	380	50	600	500	400	650
P-EI 18000	18	380	50	750	500	400	650
P-EI 21000	21	380	50	850	500	400	650
P-EI 24000	24	380	50	1000	500	400	650



Frequency Inverter



FI



MODELS	INPUT VOLTAGE (V)	OUTPUT VOLTAGE (V)	Power (kW)
P-FI 10	380	380	0,75
P-FI 15	380	380	1,5
P-FI 22	380	380	2,2
P-FI 30	380	380	3
P-FI 40	380	380	4
P-FI 55	380	380	5,5
P-FI 75	380	380	7,5
P-FI 110	380	380	11
P-FI 150	380	380	15
P-FI 185	380	380	18,5
P-FI 220	380	380	22
P-FI 300	380	380	30
P-FI 370	380	380	37



SPEED CONTROL DEVICE



HKC



MODELS	VOLTAGE (V)	CURRENT (A)
P-HKC 1	220	2
P-HKC 2	220	5
P-HKC 3	220	8



ACCESSORIES

INDUSTRIAL VANTILATOR

MFS
MFW



MODELS	VOLTAGE (V)	POWER (W)	FREQUENCY (Hz)	ROTATION SPEED (rpm)	AIR FLOW (m ³ /h)
P-MFS-500	220	100	50	1350	7000
P-MFS-650	220	130	50	1350	10500
P-MFS-750	220	150	50	1350	16200
P-MFW-500	220	100	50	1350	7000
P-MFW-650	220	130	50	1350	10500
P-MFW-750	220	150	50	1350	16200
P-MFS-S500	220	110	50	1350	8000
P-MFS-S650	220	200	50	1350	12000
P-MFS-S750	220	220	50	1350	18000
P-MFW-S500	220	110	50	1350	8000
P-MFW-S650	220	200	50	1350	12000
P-MFW-S750	220	220	50	1350	18000



LIGHTWEIGHT AND STRENGTH



HEIGHT SET BODY

ELEGANT
PROTECTIVE
GRILL



