

ÇAMLICA



Ocak / Jan 2023
Fiyat Listesi / Price List
USD

AÇIKLAMA

1. Genel satış şartları, alıcı ile ÇAMLICA Design arasındaki bir alışveriş anlaşmasıdır.

2. Alıcı, sipariş onaylandığı an bu anlaşmayı tamamen kabul etmiş olur.

FİYAT LİSTESİ VE SÜREKLİLİĞİ

1. Fiyatlara KDV dahil değildir. Standart paketleme, fiyatlara dahildir.

2. En güncel tarihli fiyat listesi, önceki fiyat listelerini iptal edip yerine geçer.

3. ÇAMLICA Design, gerekli görürse haber vermeksizin, fiyat listesinde değişiklik yapma hakkına sahiptir. Yeni fiyat listesi, alıcı firma bilgilendirildiği andan itibaren geçerli olacaktır.

4. Minimum sipariş bedeli yoktur fakat 3000 € altındaki yurtdışı siparişleri için 100 € yönetim gideri alınır.

5. Bütün fiyatlar, ÇAMLICA Design İstanbul fabrika teslim fiyatlarıdır. Farklı bir teslim şekli istenirse, alıcı ÇAMLICA Design'dan yazılı bir izin alıp sipariş onayında beyan etmelidir.

6. Siparişin ÇAMLICA Design tarafından işleme alınabilmesi için, proforma faturada belirtilen bakiyenin %50'si kapora olarak ödenmelidir.

7. Sipariş edilen ürünlerin ödemesi, yükleme tarihinden 3 gün önce banka hesabı aracılığı ile yapılmalıdır.

8. Ürünler, yüklendikten sonra müşterinin sorumluluğunda sevkedilir. Nakliyeden kaynaklanan herhangi bir hasarı ÇAMLICA Design karşılamaz.

9. Teslim tarihi yaklaşık olarak bildirilir.

10. Siparişler, ÇAMLICA Design tarafından onaylandıktan 1 gün sonra sipariş değiştirilemez ve iptal edilemez. İptal edilmesi durumunda kabul edilen teklifin %50'si temin edilir.

11. Ağırlık, boyut verenkler yaklaşık olarak belirlenir. ÇAMLICA Design, haber vermeye gerek duymaksızın, bu katalogta yer alan malzemeleri, kaplamaları, çizimleri ve detayları değiştirme hakkına sahiptir.

12. 7€ luk kumaşa ve suni deriye göre fiyatlandırılmıştır.

13. Ürünler hazır olduktan sonraki 20 gün içerisinde Çamlıca Design deposundan teslim alınmaması halinde, Her gün 1 m³ alan için 1€ depo masrafı yansıtılacaktır.

Fabrika : Yayalar Mah. Akın Sok. No:18 / 1-2 Pendik / İSTANBUL
Showroom : Mehmet Akif Mah. Bahariye Cad. No.75/A Küçükçekmece / İSTANBUL
Showroom : Kağıthane Cad. No.115 Kağıthane / İSTANBUL

☎ : +90 216 471 37 05
☎ : +90 539 939 08 57
☎ : +90 530 486 22 58

✉ : info@camlicadesign.com
🌐 : www.camlicadesign.com

Sandalyeler / Chairs

İç Mekan / Indoor

Fiyat Listesi / Price List
USD

| LUNA | | |
|---|---|----------|
|  | | |
| * | | |
| A1 SANDALYE 108001 | | |
| | | |
| | | |
| | Ö | f b |

| ERDO | | |
|---|---|----------|
|  | | |
| * | | |
| A2 SANDALYE 108002 | | |
| | | |
| | | |
| | Ö | f b |

| LASSIE | | |
|---|---|----------|
|  | | |
| * | | |
| A3 SANDALYE 108003 | | |
| | | |
| | | |
| | Ö | f b |

| FORTE | | |
|---|---|----------|
|  | | |
| x | | |
| PO 001 6201 | | |
| A | | |
| | | |
| | Ö | f b |

| FORTE | | |
|---|---|----------|
|  | | |
| x | | |
| PO 007 6207 | | |
| A | | |
| | | |
| | Ö | f b |

| FORTE | | |
|---|---|----------|
|  | | |
| x | | |
| PO 004 6204 | | |
| A | | |
| | | |
| | Ö | f b |

| FORTE | | |
|---|---|----------|
|  | | |
| x | | |
| PO 005 6205 | | |
| A | | |
| | | |
| | Ö | f b |

| NAVA | | |
|---|---|----------|
|  | | |
| x | | |
| PO 015 6215 | | |
| A | | |
| | | |
| | Ö | f b |

| BRED A | | |
|---|---|----------|
|  | | |
| x | | |
| PO 028 6228 | | |
| A | | |
| | | |
| | Ö | f b |

Sandalyeler / Chairs

İç Mekan / Indoor

Fiyat Listesi / Price List
USD

| | | |
|---|--|--|
| PIRNA | | |
|  | | |
| x | | |
| PO 032 6232 | | |
| A | | |
| Ö f b | | |

| | | |
|---|--|--|
| PLASY | | |
|  | | |
| x | | |
| PO 047 6247 | | |
| A | | |
| Ö f b | | |

| | | |
|---|--|--|
| DELFT | | |
|  | | |
| x | | |
| PO 029 6229 | | |
| A | | |
| Ö f b | | |

| | | |
|---|--|--|
| LENA | | |
|  | | |
| x | | |
| PO 017 6217 | | |
| A | | |
| Ö f b | | |

| | | |
|---|--|--|
| PINA | | |
|  | | |
| x | | |
| PO 009 6209 | | |
| A | | |
| Ö f b | | |

| | | |
|---|--|--|
| BURGO | | |
|  | | |
| x | | |
| PO 012 6212 | | |
| A | | |
| Ö f b | | |

| | | |
|---|--|--|
| BOBO | | |
|  | | |
| x | | |
| CS 110 61110 | | |
| | | |
| Ö f b | | |

| | | |
|---|--|--|
| BUA | | |
|  | | |
| x | | |
| CS 109 61109 | | |
| | | |
| Ö f b | | |

| | | |
|---|--|--|
| JAN | | |
|  | | |
| x | | |
| CS 112 61112 | | |
| | | |
| Ö f b | | |

Sandalyeler / Chairs

İç Mekan / Indoor

Fiyat Listesi / Price List
USD

| | | |
|---|--|--|
| DIAZ | | |
|  | | |
| x | | |
| PO 008 6208 | | |
| A | | |
| Ö f b | | |

| | | |
|---|--|--|
| ALFED | | |
|  | | |
| x | | |
| PO 031 6231 | | |
| A | | |
| Ö f b | | |

| | | |
|---|--|--|
| LUIZA | | |
|  | | |
| x | | |
| PO 003 6203 | | |
| A | | |
| Ö f b | | |

| | | |
|---|--|--|
| CEKU | | |
|  | | |
| x | | |
| CS 113 61113 | | |
| | | |
| Ö f b | | |

| | | |
|---|--|--|
| JAMES | | |
|  | | |
| x | | |
| PO 1304 61304 | | |
| u | | |
| Ö f b | | |

| | | |
|---|--|--|
| OTTA | | |
|  | | |
| x | | |
| PO 036 6236 | | |
| A | | |
| Ö f b | | |

| | | |
|---|--|--|
| CORVIN | | |
|  | | |
| x | | |
| PO 753 6753 | | |
| | | |
| Ö f b | | |

| | | |
|---|--|--|
| BELLA | | |
|  | | |
| x | | |
| PO 906 6906 | | |
| | | |
| Ö f b | | |

| | | |
|---|--|--|
| MOANA | | |
|  | | |
| x | | |
| CS 120 61120 | | |
| | | |
| Ö f b | | |

Sandalyeler / Chairs

İç Mekan / Indoor

Fiyat Listesi / Price List
USD

| CAMELLIA | | |
|---|--|--|
|  | | |
| x | | |
| PO 352 / 6352 | | |
| # | | |
| Ö f b | | |

| CEKS | | |
|---|--|--|
|  | | |
| x | | |
| CH-01 KOLLU SANDALYE | | |
| | | |
| Ö f b | | |

| MARY | | |
|---|--|--|
|  | | |
| x | | |
| PO 908 6908 | | |
| | | |
| Ö f b | | |

| FONTUS | | |
|---|--|--|
|  | | |
| x | | |
| PO 269 6269 | | |
| A | | |
| Ö f b | | |

| RHEA | | |
|---|--|--|
|  | | |
| x | | |
| PO 270 6270 | | |
| A | | |
| Ö f b | | |

Sandalyeler / Chairs

İç Mekan / Indoor

Fiyat Listesi / Price List
USD

| FERONIA | | |
|---|---|-----|
|  | | |
| x | | |
| PO 9011 69011 | | |
| | | |
| | | |
| | Ö | f b |

| HOLLY | | |
|---|---|-----|
|  | | |
| x | | |
| PO 1502 61502 | | |
| J | | |
| Ø | | |
| 4 Ø | | |
| | Ö | f b |

| JENA | | |
|---|---|-----|
|  | | |
| x | | |
| PO 9010 6910 | | |
| | | |
| | | |
| | Ö | f b |

| BARBEL | | |
|---|---|-----|
|  | | |
| x | | |
| PO 030 6230 | | |
| A | | |
| | | |
| | Ö | f b |

| HELERNUS | | |
|---|---|-----|
|  | | |
| x | | |
| PO 9014 69014 | | |
| | | |
| | | |
| | Ö | f b |

| LINDA | | |
|---|---|-----|
|  | | |
| x | | |
| PO 909 6909 | | |
| | | |
| | | |
| | Ö | f b |

Sandalyeler / Chairs

İç Mekan / Indoor

Fiyat Listesi / Price List
USD

| | | |
|---|--|--|
| TEO | | |
|  | | |
| x | | |
| PO 970 6970 | | |
| ü | | |
| Ö f b | | |

| | | |
|---|--|--|
| FLON | | |
|  | | |
| x | | |
| PO 027 6227 | | |
| A | | |
| Ö f b | | |

| | | |
|---|--|--|
| MOREDA | | |
|  | | |
| x | | |
| PO 016 6216 | | |
| A | | |
| Ö f b | | |

| | | |
|---|--|--|
| DINAN | | |
|  | | |
| x | | |
| PO 018 6218 | | |
| A | | |
| Ö f b | | |

| | | |
|---|--|--|
| BLOIS | | |
|  | | |
| x | | |
| PO 050 6250 | | |
| A | | |
| Ö f b | | |

| | | |
|---|--|--|
| BLOIS | | |
|  | | |
| x | | |
| PO 965 6965 | | |
| ü | | |
| Ö f b | | |

| | | |
|---|--|--|
| MOST | | |
|  | | |
| x | | |
| PO 033 6233 | | |
| A | | |
| Ö f b | | |

| | | |
|---|--|--|
| FLORA | | |
|  | | |
| x | | |
| PO 9012 69012 | | |
| | | |
| Ö f b | | |

| | | |
|---|--|--|
| WILLIAM | | |
|  | | |
| * | | |
| ÜÇ AYAKLI AHŞAP SANDALYE 61201 | | |
| | | |
| Ö f b | | |

Sandalyeler / Chairs

İç Mekan / Indoor

Fiyat Listesi / Price List
USD

| DIMA | | |
|---|--|--|
|  | | |
| x | | |
| PO 603 6603 | | |
| | | |
| Ö f b | | |

| GREA | | |
|---|--|--|
|  | | |
| x | | |
| PO 602 6602 | | |
| | | |
| Ö f b | | |

| LOTUS | | |
|---|--|--|
|  | | |
| x | | |
| PO 902 6902 | | |
| | | |
| Ö f b | | |

| WINTON | | |
|---|--|--|
|  | | |
| x | | |
| PO 710 6710 | | |
| S | | |
| Ö f b | | |

| WINTON | | |
|---|--|--|
|  | | |
| x | | |
| PO 711 6711 | | |
| S | | |
| Ö f b | | |

| PETRA | | |
|---|--|--|
|  | | |
| x | | |
| CS 111 61111 | | |
| | | |
| Ö f b | | |

| MARIA | | |
|---|--|--|
|  | | |
| x | | |
| PO 903 6903 | | |
| | | |
| Ö f b | | |

| SUZI | | |
|---|--|--|
|  | | |
| x | | |
| PO 901 6901 | | |
| | | |
| Ö f b | | |

Sandalyeler / Chairs

İç Mekan / Indoor

Fiyat Listesi / Price List
USD

| RAYA | | |
|---|---|--|
|  | | |
| x | | |
| CS 119 61119 | | |
| | ü | |
| | | |
| Ö f b | | |

| LOVA | | |
|---|---|--|
|  | | |
| x | | |
| PO 968 6968 | | |
| | ü | |
| | | |
| Ö f b | | |

| DOBI | | |
|---|---|--|
|  | | |
| x | | |
| CS 114 61114 | | |
| | ü | |
| | | |
| Ö f b | | |

| JUAN | | |
|---|---|--|
|  | | |
| x | | |
| PO 962 6962 | | |
| | ü | |
| | | |
| Ö f b | | |

| PUCA | | |
|---|---|--|
|  | | |
| x | | |
| PO 967 6967 | | |
| | ü | |
| | | |
| Ö f b | | |

| ROCA | | |
|---|---|--|
|  | | |
| x | | |
| PO 964 6964 | | |
| | ü | |
| | | |
| Ö f b | | |

| LILAC | | |
|---|--|--|
|  | | |
| x | | |
| PO 353 / 6353 | | |
| # | | |
| | | |
| Ö f b | | |

| MARLEY | | |
|---|--|--|
|  | | |
| x | | |
| PO 024 6224 | | |
| A | | |
| | | |
| Ö f b | | |

Ahşap Ürünler

Fiyat Listesi / Price List
USD



Sandalyeler / Chairs

İç Mekan / Indoor

Fiyat Listesi / Price List
USD

| | | |
|---|--|--|
| ERIC | | |
|  | | |
| x | | |
| PO 021 6221 | | |
| A | | |
| Ö f b | | |

| | | |
|---|--|--|
| VALGA | | |
|  | | |
| x | | |
| PO 709 6709 | | |
| S | | |
| Ö f b | | |

| | | |
|---|--|--|
| CARRIL | | |
|  | | |
| x | | |
| PO 803 6803 | | |
| | | |
| Ö f b | | |

| | | |
|---|--|--|
| PALI | | |
|  | | |
| x | | |
| PO 604 6604 | | |
| | | |
| Ö f b | | |

| | | |
|---|--|--|
| AGRA | | |
|  | | |
| x | | |
| PO 605 6605 | | |
| | | |
| Ö f b | | |

| | | |
|---|--|--|
| CRAIG | | |
|  | | |
| x | | |
| PO 025 6225 | | |
| A | | |
| Ö f b | | |

| | | |
|---|--|--|
| PONTO | | |
|  | | |
| x | | |
| PO 014 6214 | | |
| A | | |
| Ö f b | | |

| | | |
|---|--|--|
| CLIFF | | |
|  | | |
| x | | |
| CS 106 61106 | | |
| | | |
| Ö f b | | |

| | | |
|---|--|--|
| TELYN | | |
|  | | |
| x | | |
| AHŞAP SANDALYE | | |
| | | |
| Ö f b | | |

Sandalyeler / Chairs

İç Mekan / Indoor

Fiyat Listesi / Price List
USD

| DOGA | | |
|---|--|--|
|  | | |
| X | | |
| CS 107 61107 | | |
| | | |
| Ö f b | | |

| DANON | | |
|---|--|--|
|  | | |
| X | | |
| PO 707 6707 | | |
| S | | |
| Ö f b | | |

| ROD | | |
|---|--|--|
|  | | |
| X | | |
| PO 612 6612 | | |
| | | |
| Ö f b | | |

| AMARA | | |
|---|--|--|
|  | | |
| X | | |
| PO 751 6751 | | |
| | | |
| Ö f b | | |

| PAU | | |
|---|--|--|
|  | | |
| X | | |
| PAU AHŞAP SANDALYE | | |
| | | |
| Ö f b | | |

| AULI | | |
|---|--|--|
|  | | |
| X | | |
| PO 615 6615 | | |
| | | |
| Ö f b | | |

| AXEL | | |
|---|--|--|
|  | | |
| X | | |
| PO 1301 61301 | | |
| u | | |
| Ö f b | | |

| BARBARA | | |
|---|--|--|
|  | | |
| X | | |
| PO 1302 61302 | | |
| u | | |
| Ö f b | | |

| ZILA | | |
|---|--|--|
|  | | |
| X | | |
| PO 1616 61616 | | |
| | | |
| Ö f b | | |

Sandalyeler / Chairs

İç Mekan / Indoor

Fiyat Listesi / Price List
USD

| ROGERS | | |
|---|--|--|
|  | | |
| x | | |
| PO 655 6655 | | |
| ö | | |
| | | |
| Ö f b | | |

| PEI | | |
|---|--|--|
|  | | |
| x | | |
| PO 652 6652 | | |
| ö | | |
| | | |
| Ö f b | | |

| RICHARD | | |
|---|--|--|
|  | | |
| x | | |
| PO 653 6653 | | |
| ö | | |
| | | |
| Ö f b | | |

Sandalyeler / Chairs

İç Mekan / Indoor

Fiyat Listesi / Price List
USD

| INSALDE | | |
|---|--|--|
|  | | |
| x | | |
| PO 701 6701 | | |
| S | | |
| Ö f b | | |

| GANFE | | |
|---|--|--|
|  | | |
| x | | |
| PO 702 6702 | | |
| Su | | |
| Sø | | |
| Ö f b | | |

| LUZ | | |
|---|--|--|
|  | | |
| x | | |
| PO 703 6703 | | |
| SK | | |
| Sø | | |
| Ö f b | | |

| FRAGA | | |
|---|--|--|
|  | | |
| x | | |
| PO 704 6704 | | |
| S | | |
| Ö f b | | |

| BONNA | | |
|---|--|--|
|  | | |
| x | | |
| PO 705 6705 | | |
| S | | |
| SÖ | | |
| Ö f b | | |

| AMARA | | |
|---|--|--|
|  | | |
| x | | |
| PO 752 6752 | | |
| | | |
| Ö f b | | |

| ANDRA | | |
|---|--|--|
|  | | |
| x | | |
| PO 606 6606 | | |
| | | |
| Ö f b | | |

| VEDRA | | |
|---|--|--|
|  | | |
| x | | |
| PO 708 6708 | | |
| S | | |
| Ö f b | | |

| ARRAH | | |
|---|--|--|
|  | | |
| x | | |
| PO 607 6607 | | |
| | | |
| Ö f b | | |

Sandalyeler / Chairs

İç Mekan / Indoor

Fiyat Listesi / Price List
USD

| | | |
|---|--|--|
| KAEN | | |
|  | | |
| x | | |
| PO 609 6609 | | |
| | | |
| Ö f b | | |

| | | |
|---|--|--|
| REWA | | |
|  | | |
| x | | |
| PO 608 6608 | | |
| | | |
| Ö f b | | |

| | | |
|---|--|--|
| FOXY | | |
|  | | |
| x | | |
| PO 856 6856 | | |
| q | | |
| Ö f b | | |

| | | |
|---|--|--|
| VENÜS | | |
|  | | |
| x | | |
| PO 613 6613 | | |
| | | |
| Ö f b | | |

| | | |
|---|--|--|
| BOGO | | |
|  | | |
| x | | |
| CS 104 61104 | | |
| | | |
| Ö f b | | |

| | | |
|---|--|--|
| FORK | | |
|  | | |
| x | | |
| CS 033 6133 | | |
| Ö | | |
| Ö f b | | |

| | | |
|---|--|--|
| CANA | | |
|  | | |
| x | | |
| CS 046 6146 | | |
| Ö | | |
| Ö f b | | |

| | | |
|---|--|--|
| LAOS | | |
|  | | |
| x | | |
| CS 102 61102 | | |
| | | |
| Ö f b | | |

| | | |
|---|--|--|
| MANDY | | |
|  | | |
| x | | |
| PO 617 6617 | | |
| | | |
| Ö f b | | |

Sandalyeler / Chairs

İç Mekan / Indoor

Fiyat Listesi / Price List
USD

| | | |
|---|--|--|
| PAMA | | |
|  | | |
| x | | |
| PO 1501 61501 | | |
| J | | |
| ø | | |
| 4 ø | | |
| Ö f b | | |

| | | |
|---|--|--|
| HOLM | | |
|  | | |
| x | | |
| PO 501 6501 | | |
| ø | | |
| Ö f b | | |

| | | |
|---|--|--|
| HOLM | | |
|  | | |
| x | | |
| PO 618 6618 | | |
| | | |
| Ö f b | | |

| | | |
|---|--|--|
| FRANK | | |
|  | | |
| x | | |
| PO 1307 61307 | | |
| u | | |
| Ö f b | | |

| | | |
|---|--|--|
| MING | | |
|  | | |
| x | | |
| PO 651 6651 | | |
| ö | | |
| Ö f b | | |

| | | |
|---|--|--|
| MING | | |
|  | | |
| x | | |
| PO 654 6654 | | |
| ö | | |
| Ö f b | | |

| | | |
|---|--|--|
| TAPASAKE | | |
|  | | |
| * | | |
| ÖRME SANDALYE 157001 | | |
| | | |
| Ö f b | | |

| | | |
|---|--|--|
| WEGNER | | |
|  | | |
| x | | |
| PO 1401 61401 | | |
| Jø | | |
| Ö f b | | |

| | | |
|---|--|--|
| HERMAN | | |
|  | | |
| x | | |
| PO 1403 61403 | | |
| Jø | | |
| Ö f b | | |

Sandalyeler / Chairs

İç Mekan / Indoor

Fiyat Listesi / Price List
USD

| | | |
|---|--|--|
| HENRI | | |
|  | | |
| x | | |
| PO 1303 61303 | | |
| u | | |
| | | |
| Ö f b | | |

| | | |
|---|--|--|
| ALMADA | | |
|  | | |
| * | | |
| SANDALYE3-SA | | |
| | | |
| | | |
| Ö f b | | |

| | | |
|---|--|--|
| ENSOR | | |
|  | | |
| x | | |
| PO 1305 61305 | | |
| u | | |
| | | |
| Ö f b | | |

| | | |
|---|--|--|
| RAOUL | | |
|  | | |
| x | | |
| PO 1306 61306 | | |
| u | | |
| | | |
| Ö f b | | |

| | | |
|---|--|--|
| MONDRIAN | | |
|  | | |
| x | | |
| PO 1308 61308 | | |
| u | | |
| | | |
| Ö f b | | |

| | | |
|---|--|--|
| HANS | | |
|  | | |
| x | | |
| PO 1309 61309 | | |
| u | | |
| | | |
| Ö f b | | |

| | | |
|---|--|--|
| LLOYD | | |
|  | | |
| x | | |
| PO 1310 61310 | | |
| u | | |
| | | |
| Ö f b | | |

| | | |
|---|--|--|
| MIES | | |
|  | | |
| x | | |
| PO 1311 61311 | | |
| u | | |
| | | |
| Ö f b | | |

| | | |
|---|--|--|
| ROHE | | |
|  | | |
| x | | |
| PO 1312 61312 | | |
| u | | |
| | | |
| Ö f b | | |

Sandalyeler / Chairs

İç Mekan / Indoor

Fiyat Listesi / Price List
USD

| RAHN | |
|---|--|
|  | |
| x | |
| PO 1313 61313 | |
| u | |
| | |
| Ö f b | |

| GEHRY | |
|---|--|
|  | |
| x | |
| PO 1314 61314 | |
| u | |
| | |
| Ö f b | |

Sandalyeler / Chairs

İç Mekan / Indoor

Fiyat Listesi / Price List
USD

| TWING | | |
|---|--|--|
|  | | |
| x | | |
| CS 403 6403 | | |
| J | | |
| Ö f b | | |

| TWING | | |
|---|--|--|
|  | | |
| x | | |
| CS 404 6404 | | |
| J | | |
| Ö f b | | |

| TWING | | |
|---|--|--|
|  | | |
| x | | |
| CS 105 61105 | | |
| J | | |
| Ö f b | | |

| TWING | | |
|---|--|--|
|  | | |
| * | | |
| CS 116006 TWIG LOUNCE | | |
| J | | |
| Ö f b | | |

| PETRI | | |
|---|--|--|
|  | | |
| x | | |
| CS 406 6406 | | |
| J | | |
| Ö f b | | |

| PETRI | | |
|---|--|--|
|  | | |
| x | | |
| CS 415 6415 | | |
| J | | |
| Ö f b | | |

| BANF | | |
|---|--|--|
|  | | |
| x | | |
| CS 409 6409 | | |
| J | | |
| Ö f b | | |

| BANF | | |
|---|--|--|
|  | | |
| x | | |
| CS 408 6408 | | |
| J | | |
| Ö f b | | |

Sandalyeler / Chairs

İç Mekan / Indoor

Fiyat Listesi / Price List
USD

| BOLTON | | |
|---|--|--|
|  | | |
| x | | |
| CS 410 6410 | | |
| J | | |
| Ö f b | | |

| BOLTON | | |
|---|--|--|
|  | | |
| x | | |
| CS 412 6412 | | |
| J | | |
| Ö f b | | |

Sandalyeler / Chairs

İç Mekan / Indoor

Fiyat Listesi / Price List
USD

| ISLAY | | |
|---|--|--|
|  | | |
| x | | |
| CS 001 6101 | | |
| Ö | | |
| Ö f b | | |

| ISLAY | | |
|---|--|--|
|  | | |
| x | | |
| CS 003 6103 | | |
| Ö | | |
| Ö f b | | |

| ISLAY | | |
|---|--|--|
|  | | |
| x | | |
| CS 011 6111 | | |
| Ö | | |
| Ö f b | | |

| SANNA | | |
|---|--|--|
|  | | |
| x | | |
| CS 002 6102 | | |
| Ö | | |
| Ö f b | | |

| SANNA | | |
|---|--|--|
|  | | |
| x | | |
| CS 004 6104 | | |
| Ö | | |
| Ö f b | | |

| GARRY | | |
|---|--|--|
|  | | |
| x | | |
| CS 012 6112 | | |
| Ö | | |
| Ö f b | | |

| ISLAY | | |
|---|--|--|
|  | | |
| x | | |
| CS 047 6147 | | |
| Ö | | |
| Ö f b | | |

| JODI | | |
|---|--|--|
|  | | |
| x | | |
| CS 014 6114 | | |
| Ö | | |
| Ö f K b | | |

| JODI | | |
|---|--|--|
|  | | |
| x | | |
| CS 013 6113 | | |
| Ö | | |
| Ö f b | | |

Sandalyeler / Chairs

İç Mekan / Indoor

Fiyat Listesi / Price List
USD

| BUN | | |
|---|--|--|
|  | | |
| x | | |
| CS 016 6116 | | |
| Ö | | |
| Ö f b | | |

| BUN | | |
|---|--|--|
|  | | |
| x | | |
| CS 015 6115 | | |
| Ö | | |
| Ö f b | | |

| STURY | | |
|---|--|--|
|  | | |
| x | | |
| CS 018 6118 | | |
| Ö | | |
| Ö f b | | |

| STURY | | |
|---|--|--|
|  | | |
| x | | |
| CS 017 6117 | | |
| Ö | | |
| Ö f b | | |

| TOMICH | | |
|---|--|--|
|  | | |
| x | | |
| CS 020 6120 | | |
| Ö | | |
| Ö f b | | |

| TOMICH | | |
|---|--|--|
|  | | |
| x | | |
| CS 019 6119 | | |
| Ö | | |
| Ö f b | | |

| ALLOA | | |
|---|--|--|
|  | | |
| x | | |
| CS 022 6122 | | |
| Ö | | |
| Ö f b | | |

| ALLOA | | |
|---|--|--|
|  | | |
| x | | |
| CS 012 6121 | | |
| Ö | | |
| Ö f b | | |

Sandalyeler / Chairs

İç Mekan / Indoor

Fiyat Listesi / Price List
USD

| JODI | | |
|---|--|--|
|  | | |
| x | | |
| CS 028 6128 | | |
| Ö | | |
| Ö f b | | |

| JODI | | |
|---|--|--|
|  | | |
| x | | |
| CS 027 6127 | | |
| Ö | | |
| Ö f b | | |

| TOMICH | | |
|---|--|--|
|  | | |
| x | | |
| CS 030 6130 | | |
| Ö | | |
| Ö f b | | |

| TOMICH | | |
|---|--|--|
|  | | |
| x | | |
| CS 029 6129 | | |
| Ö | | |
| Ö f b | | |

| WICTON | | |
|---|--|--|
|  | | |
| x | | |
| CS 025 6125 | | |
| Ö | | |
| Ö f b | | |

| WICTON | | |
|---|--|--|
|  | | |
| x | | |
| CS 034 6134 | | |
| Ö | | |
| Ö f b | | |

Sandalyeler / Chairs

İç Mekan / Indoor

Fiyat Listesi / Price List
USD

| GARRY | | |
|---|--|--|
|  | | |
| x | | |
| CS 006 6106 | | |
| Ö | | |
| | | |
| Ö f b | | |

| GARRY | | |
|---|--|--|
|  | | |
| x | | |
| CS 010 6110 | | |
| Ö | | |
| | | |
| Ö f b | | |

| GARRY | | |
|---|--|--|
|  | | |
| x | | |
| CS 008 6108 | | |
| Ö | | |
| | | |
| Ö f b | | |

| ISLAY | | |
|---|--|--|
|  | | |
| x | | |
| CS 005 6105 | | |
| Ö | | |
| | | |
| Ö f b | | |

| ISLAY | | |
|---|--|--|
|  | | |
| x | | |
| CS 009 6109 | | |
| Ö | | |
| | | |
| Ö f b | | |

| ISLAY | | |
|---|--|--|
|  | | |
| x | | |
| CS 007 6107 | | |
| Ö | | |
| | | |
| Ö f b | | |

| WICTON | | |
|---|---|--|
|  | | |
| x | | |
| CS 024 6124 | | |
| Ö | | |
| | | |
| f | b | |

| WICTON | | |
|---|--|--|
|  | | |
| x | | |
| CS 026 6126 | | |
| Ö | | |
| | | |
| Ö f b | | |

| WICTON | | |
|---|--|--|
|  | | |
| x | | |
| CS 023 6123 | | |
| Ö | | |
| | | |
| Ö f b | | |

Sandalyeler / Chairs

İç Mekan / Indoor

Fiyat Listesi / Price List
USD

| GRAZ | | |
|---|---|-----|
|  | | |
| X | | |
| CS 103 61103 | | |
| | | |
| | | |
| | Ö | f b |

| AXEL | | |
|---|-----|-----|
|  | | |
| X | | |
| PO 1301_H 61301_H | | |
| | f u | |
| | | |
| | Ö | f b |

| GRAF | | |
|---|---|-----|
|  | | |
| * | | |
| PO 1302_H 61302_H | | |
| | J | |
| | | |
| | Ö | f b |

| PUFI | | |
|---|---|-----|
|  | | |
| X | | |
| CS 116 61116 | | |
| | | |
| | | |
| | Ö | f b |

| FLORIAN | | |
|---|---|-----|
|  | | |
| X | | |
| CS 117 61117 | | |
| | | |
| | | |
| | Ö | f b |

| BORIS | | |
|---|---|-----|
|  | | |
| X | | |
| PO 616 6616 | | |
| | | |
| | | |
| | Ö | f b |

| ENNIS | | |
|---|---|-----|
|  | | |
| X | | |
| PO 010 6210 | | |
| | A | |
| | | |
| | Ö | f b |

| ONICA | | |
|---|---|-----|
|  | | |
| X | | |
| PO 1701 61701 | | |
| | 1 | |
| | | |
| | Ö | f b |

Sandalyeler / Chairs

İç Mekan / Indoor

Fiyat Listesi / Price List
USD

| GRAF | | |
|---|--|--|
|  | | |
| * | | |
| KOLSUZ HAZERANLI 681 | | |
| J | | |
| ø | | |
| 4 ø | | |
| Ö f b | | |

| GRAF | | |
|---|--|--|
|  | | |
| * | | |
| KOLLU HAZERANLI 684 | | |
| J | | |
| ø | | |
| 4 ø | | |
| Ö f b | | |

Sandalyeler / Chairs

İç Mekan / Indoor

Fiyat Listesi / Price List
USD

| | | |
|---|--|--|
| LUNA | | |
|  | | |
| x | | |
| PO 066 6266 | | |
| A | | |
| Ö f b | | |

| | | |
|---|--|--|
| VESTA | | |
|  | | |
| x | | |
| PO 067 6267 | | |
| A | | |
| Ö f b | | |

| | | |
|---|--|--|
| ORTON | | |
|  | | |
| x | | |
| PO 006 6206 | | |
| A | | |
| Ö f b | | |

| | | |
|---|--|--|
| STON | | |
|  | | |
| x | | |
| PO 610 6610 | | |
| | | |
| Ö f b | | |

| | | |
|---|--|--|
| BRAY | | |
|  | | |
| x | | |
| PO 013 6213 | | |
| A | | |
| Ö f b | | |

| | | |
|---|--|--|
| TRIM | | |
|  | | |
| x | | |
| CS 101 61101 | | |
| Ö | | |
| # | | |
| Ö f b | | |

| | | |
|---|--|--|
| DOUGLAS | | |
|  | | |
| * | | |
| HAZERANLI KOLTUK 05 690 | | |
| u ø | | |
| Ö f b | | |

| | | |
|---|--|--|
| PITRA | | |
|  | | |
| x | | |
| PO 611 6611 | | |
| | | |
| Ö f b | | |

| | | |
|---|--|--|
| GEHRY | | |
|  | | |
| x | | |
| PO 1314_H 61314_H | | |
| f u | | |
| Ö f b | | |

Sandalyeler / Chairs

İç Mekan / Indoor

Fiyat Listesi / Price List
USD

| WICTON | | |
|---|--|--|
|  | | |
| x | | |
| CS 032 6132 | | |
| Ö | | |
| Ö f b | | |

| WICTON | | |
|---|--|--|
|  | | |
| x | | |
| CS 031 6131 | | |
| Ö | | |
| Ö f b | | |

| NAVEEN | | |
|---|--|--|
|  | | |
| x | | |
| CS 118 6118 | | |
| Ö | | |
| Ö f b | | |

| WICTON | | |
|---|--|--|
|  | | |
| x | | |
| CS 050 6150 | | |
| Ö | | |
| Ö f b | | |

| CANA | | |
|---|--|--|
|  | | |
| x | | |
| CS 051 6151 | | |
| Ö | | |
| Ö f b | | |

| REI | | |
|---|--|--|
|  | | |
| x | | |
| CS 053 6153 | | |
| Ö | | |
| Ö f b | | |

| HENRI | | |
|---|--|--|
|  | | |
| x | | |
| PO 1303_H 61303_H | | |
| f u | | |
| Ö f b | | |

Sandalyeler / Chairs

İç Mekan / Indoor

Fiyat Listesi / Price List
USD

| PALMA | | |
|---|--|--|
|  | | |
| x | | |
| PO 502 6502 | | |
| ø | | |
| Ö f b | | |

| PALMA | | |
|---|--|--|
|  | | |
| x | | |
| PO 503 6503 | | |
| ø | | |
| Ö f b | | |

| PALMA | | |
|---|--|--|
|  | | |
| x | | |
| PO 504 6504 | | |
| ø | | |
| Ö f b | | |

| VIGO | | |
|---|--|--|
|  | | |
| x | | |
| PO 506 6506 | | |
| ø | | |
| Ö f b | | |

| VIGO | | |
|---|--|--|
|  | | |
| x | | |
| PO 507 6507 | | |
| ø | | |
| Ö f b | | |

Sandalyeler / Chairs

İç Mekan / Indoor

Fiyat Listesi / Price List
USD

| ESTOR | | |
|---|--|--|
|  | | |
| * | | |
| NO3 721 | | |
| J | | |
| ø | | |
| 4 ø | | |
| Ö f b | | |

| ESTOR | | |
|---|--|--|
|  | | |
| * | | |
| NO3 TEL SANDALYE 722 | | |
| J | | |
| ø | | |
| 4 ø | | |
| Ö f b | | |

| JONU TA | | |
|---|--|--|
|  | | |
| * | | |
| NO4 724 | | |
| J | | |
| ø | | |
| 4 ø | | |
| Ö f b | | |

| TIANA | | |
|---|--|--|
|  | | |
| * | | |
| NO1 KOLLU SANDALYE 701 | | |
| J | | |
| ø | | |
| 4 ø | | |
| Ö f b | | |

| TIANA | | |
|---|--|--|
|  | | |
| * | | |
| NO1 KOLSUZ SANDALYE 702 | | |
| J | | |
| ø | | |
| 4 ø | | |
| Ö f b | | |

| CUP | | |
|---|--|--|
|  | | |
| * | | |
| KUPA SANDALYE 582 | | |
| J | | |
| ø | | |
| 4 ø | | |
| Ö f b | | |

| TUNAS | | |
|---|--|--|
|  | | |
| * | | |
| NO2 SANDALYE 710 | | |
| J | | |
| ø | | |
| 4 ø | | |
| Ö f b | | |

| TUNAS | | |
|---|--|--|
|  | | |
| * | | |
| NO2 KOLLU SANDALYE 711 | | |
| J | | |
| ø | | |
| 4 ø | | |
| Ö f b | | |

| TERNI | | |
|---|--|--|
|  | | |
| * | | |
| CMD 18 300 | | |
| J | | |
| ø | | |
| 4 ø | | |
| Ö f b | | |

Sandalyeler / Chairs

İç Mekan / Indoor

Fiyat Listesi / Price List
USD

| GALL | | |
|---|---|-----|
|  | | |
| * | | |
| NO26 769 | | |
| J | | |
| # | | |
| | Ö | f b |

| RİBAH | | |
|---|---|-----|
|  | | |
| * | | |
| NO27 770 | | |
| J | | |
| # | | |
| | Ö | f b |

| PAMA | | |
|---|---|-----|
|  | | |
| x | | |
| NO28 771 | | |
| J | | |
| | Ö | f b |

| TAMARA | | |
|---|---|-----|
|  | | |
| x | | |
| PO 108004 A4 SANDALYE | | |
| | Ö | f b |

| BODDEN | | |
|---|---|-------|
|  | | |
| * | | |
| ÖZEL MODEL SANDALYE 773 | | |
| J | | |
| ø_ | | |
| 4 ø | | |
| | Ö | f K b |

| SUZİ | | |
|---|---|-----|
|  | | |
| x | | |
| PO 901 6901 | | |
| | Ö | f b |

| MİR | | |
|---|---|-----|
|  | | |
| * | | |
| LT MİR 6211 | | |
| J | | |
| ø_ | | |
| 4 ø | | |
| | Ö | f b |

| HTL | | |
|---|---|-----|
|  | | |
| * | | |
| ÇAPRAZ AYAKLI 6212 | | |
| 1 J | | |
| 1 ø_ | | |
| 1 4 ø | | |
| | Ö | f b |

| MARİA | | |
|---|---|-----|
|  | | |
| x | | |
| PO 903 6903 | | |
| | Ö | f b |

Sandalyeler / Chairs

İç Mekan / Indoor

Fiyat Listesi / Price List
USD

| STELLA | | |
|---|-----|---|
|  | | |
| * SANDALYE 775 | | |
| J | | |
| ø_ | | |
| 4 ø | | |
| | Ö f | b |

| BAT | | |
|---|-----|---|
|  | | |
| * BAT SANDALYE 601 | | |
| J | | |
| ø_ | | |
| 4 ø | | |
| | Ö f | b |

| SUN | | |
|---|-----|---|
|  | | |
| * GÜNEŞ SANDALYE 630 | | |
| J | | |
| ø_ | | |
| 4 ø | | |
| | Ö f | b |

| FREDO | | |
|---|-----|---|
|  | | |
| * GÜNEŞ SANDALYE 630Ö | | |
| 1 J | | |
| 1 øJ | | |
| | Ö f | b |

| MATISSE | | |
|---|-----|---|
|  | | |
| * QBAZ SANDALYE | | |
| J | | |
| ø_ | | |
| 4 ø | | |
| | Ö f | b |

| MOCHA | | |
|---|-----|---|
|  | | |
| * PO 107007 EMR HOT SANDALYE | | |
| J | | |
| ø_ | | |
| 4 ø# | | |
| | Ö f | b |

| HOOKAH | | |
|---|-----|---|
|  | | |
| * HOOKAH SANDALYE 100014 | | |
| JA | | |
| | Ö f | b |

Sandalyeler / Chairs

İç Mekan / Indoor

Fiyat Listesi / Price List
USD

| ANNA | | |
|---|-----|---|
|  | | |
| * | | |
| NO30 104003 | | |
| J | | |
| ø | | |
| 4 ø# | | |
| | Ö f | b |

| IRENE | | |
|---|-----|---|
|  | | |
| * | | |
| NO32 SANDALYE 104004 | | |
| J | | |
| ø | | |
| 4 ø | | |
| # | | |
| | Ö f | b |

| MERIDA | | |
|---|-----|---|
|  | | |
| * | | |
| GRM ÜÇGEN SANDALYE 148002 | | |
| # | | |
| # | | |
| | Ö f | b |

| SUMBA | | |
|---|-----|---|
|  | | |
| * | | |
| NO14 749 | | |
| J | | |
| ø | | |
| # | | |
| | Ö f | b |

| ANIKA | | |
|---|-----|---|
|  | | |
| * | | |
| NO8 741 | | |
| J | | |
| ø | | |
| # | | |
| | Ö f | b |

| FLEX | | |
|---|-----|---|
|  | | |
| * | | |
| FLEX 03 132 | | |
| J | | |
| ø | | |
| 4 ø | | |
| | Ö f | b |

Sandalyeler / Chairs

İç Mekan / Indoor

Fiyat Listesi / Price List
USD

| LOUIS | | |
|---|--|--|
|  | | |
| * | | |
| NO9 742 | | |
| J | | |
| ø | | |
| 4 ø | | |
| Ö f b | | |

| LOUIS | | |
|---|--|--|
|  | | |
| * | | |
| NO10 743 | | |
| J | | |
| ø | | |
| 4 ø | | |
| Ö f b | | |

| UBON | | |
|---|--|--|
|  | | |
| * | | |
| NO18 757 | | |
| J | | |
| ø | | |
| 4 ø | | |
| Ö f b | | |

| MARC | | |
|---|--|--|
|  | | |
| * | | |
| NO20 763 | | |
| J | | |
| ø | | |
| 4 ø | | |
| Ö f b | | |

| TUENA | | |
|---|--|--|
|  | | |
| * | | |
| NO15 SANDALYE 750 | | |
| J | | |
| ø | | |
| # | | |
| Ö f b | | |

| BALLOON | | |
|---|--|--|
|  | | |
| * | | |
| NO17 754 | | |
| J | | |
| ø | | |
| 4 ø | | |
| Ö f b | | |

| CAPE | | |
|---|--|--|
|  | | |
| * | | |
| NO16 KOLLU 752 | | |
| J | | |
| ø | | |
| 4 ø | | |
| Ö f b | | |

| CAPE | | |
|---|--|--|
|  | | |
| * | | |
| NO16 KOLSUZ 753 | | |
| J | | |
| ø | | |
| 4 ø | | |
| Ö f b | | |

| CAMBI | | |
|---|--|--|
|  | | |
| * | | |
| NO21 764 | | |
| J | | |
| ø | | |
| 4 ø | | |
| Ö f b | | |

Sandalyeler / Chairs

İç Mekan / Indoor

Fiyat Listesi / Price List
USD

| PETI | | |
|---|--|--|
|  | | |
| * | | |
| NO19 760 | | |
| J | | |
| ø | | |
| 4 ø | | |
| Ö f b | | |

| HOFF | | |
|---|--|--|
|  | | |
| * | | |
| NO11 744 | | |
| J | | |
| ø | | |
| 4 ø | | |
| Ö f b | | |

| DIRECTOR | | |
|---|--|--|
|  | | |
| * | | |
| NO23 766 | | |
| 4 ø | | |
| Ö f b | | |

| STUDI | | |
|---|--|--|
|  | | |
| * | | |
| CMD 15 323 | | |
| J | | |
| ø | | |
| 4 ø | | |
| Ö f b | | |

| BANI | | |
|---|--|--|
|  | | |
| * | | |
| NO12 745 | | |
| J | | |
| ø | | |
| 4 ø | | |
| Ö f b | | |

| RUSSI | | |
|---|--|--|
|  | | |
| x | | |
| PO 011 6211 | | |
| A | | |
| Ö f b | | |

| VEGA | | |
|---|--|--|
|  | | |
| x | | |
| PO 020 6220 | | |
| A | | |
| Ö f b | | |

| ETHAN | | |
|---|--|--|
|  | | |
| x | | |
| PO 913 6913 | | |
| Ö f b | | |

Sandalyeler / Chairs

İç Mekan / Indoor

Fiyat Listesi / Price List
USD

| ELSA | | |
|---|---|-----|
|  | | |
| X | | |
| PO 905 6905 | | |
| | | |
| | | |
| | Ö | f b |

| JUVENTAS | | |
|---|---|-----|
|  | | |
| X | | |
| PO 9015 6915 | | |
| | | |
| | | |
| | Ö | f b |

| PUCON | | |
|---|---|-----|
|  | | |
| X | | |
| PO 963 6963 | | |
| ü | | |
| | | |
| | Ö | f b |

| AVRORA | | |
|---|---|-----|
|  | | |
| * | | |
| CMD 20 302 | | |
| J | | |
| ø_ | | |
| 4 ø | | |
| | Ö | f b |

| BERN | | |
|---|---|-----|
|  | | |
| * | | |
| CMD 21 303 | | |
| J | | |
| ø_ | | |
| 4 ø | | |
| | Ö | f b |

| NATAL | | |
|---|---|-----|
|  | | |
| X | | |
| PO 966 6966 | | |
| ü | | |
| | | |
| | Ö | f b |

| SUHEDA | | |
|---|---|-----|
|  | | |
| * | | |
| SUHEDA 327 | | |
| J | | |
| ø_ | | |
| 4 ø | | |
| | Ö | f b |

| KAYRA | | |
|---|---|-----|
|  | | |
| * | | |
| KOLLU KAYRA 325 | | |
| J | | |
| ø_ | | |
| 4 ø | | |
| | Ö | f b |

| KAYRA | | |
|---|---|-----|
|  | | |
| * | | |
| KAYRA KOLSUZ 326 | | |
| J | | |
| ø_ | | |
| 4 ø | | |
| | Ö | f b |

Sandalyeler / Chairs

İç Mekan / Indoor

Fiyat Listesi / Price List
USD

| STAR | | |
|---|-----|---|
|  | | |
| * | | |
| AHŞAP AYAKLI YILDIZ SANDALYE 104 | | |
| J | | |
| ø | | |
| 4 ø | | |
| | Ö f | b |

| ZIRA | | |
|---|-----|---|
|  | | |
| * | | |
| AHŞAP AYAKLI KISA ZİRA SANDALYE 143 | | |
| J | | |
| ø | | |
| 4 ø | | |
| | Ö f | b |

| ZIRA | | |
|---|-----|---|
|  | | |
| * | | |
| AHŞAP AYAKLI UZUN ZİRA SANDALYE 163 | | |
| J | | |
| ø | | |
| 4 ø | | |
| | Ö f | b |

| CRESCENT | | |
|---|-----|---|
|  | | |
| * | | |
| AHŞAP AYAKLI HİLAL SANDALYE 182 | | |
| J | | |
| ø | | |
| 4 ø | | |
| | Ö f | b |

| PYRAMID | | |
|---|-----|---|
|  | | |
| * | | |
| AHŞAP AYAKLI PİRAMİT SANDALYE 502 | | |
| J | | |
| ø | | |
| 4 ø | | |
| | Ö f | b |

| ÇAMLICA | | |
|---|-----|---|
|  | | |
| * | | |
| AHŞAP AYAKLI ÇAMLICA SANDALYE 522 | | |
| J | | |
| ø | | |
| 4 ø | | |
| | Ö f | b |

| METAL | | |
|---|-----|---|
|  | | |
| * | | |
| AHŞAP AYAKLI METAL SANDALYE 202 | | |
| J | | |
| ø | | |
| 4 ø | | |
| | Ö f | b |

| GANEM | | |
|---|-----|---|
|  | | |
| * | | |
| AHŞAP AYAKLI GANEM SANDALYE 542 | | |
| J | | |
| ø | | |
| 4 ø | | |
| | Ö f | b |

| PİNO | | |
|---|-----|---|
|  | | |
| * | | |
| PİNO 552 | | |
| J | | |
| ø | | |
| 4 ø | | |
| | Ö f | b |

Sandalyeler / Chairs

İç Mekan / Indoor

Fiyat Listesi / Price List
USD

| DOLUNAY | | |
|---|-----|---|
|  | | |
| * | | |
| AHŞAP AYAKLI DOLUNAY SANDALYE 222 | | |
| J | | |
| ø | | |
| 4 ø | | |
| | Ö f | b |

| BEND | | |
|---|-----|---|
|  | | |
| * | | |
| AHŞAP AYAKLI BEND SANDALYE 662 | | |
| J | | |
| ø | | |
| 4 ø | | |
| | Ö f | b |

| MADİN | | |
|---|-----|---|
|  | | |
| * | | |
| AHŞAP AYAKLI MADİN SANDALYE 123 | | |
| J | | |
| ø | | |
| 4 ø | | |
| | Ö f | b |

Sandalyeler / Chairs

İç_Dış Mekan / Indoor_Outdoor

Fiyat Listesi / Price List
USD

| STAR | | |
|---|---|-----|
|  | | |
| * | | |
| YILDIZ AYAKLI YILDIZ SANDALYE 101 | | |
| J | | |
| ø | | |
| 4 ø | | |
| | Ö | f b |

| STAR | | |
|---|---|-----|
|  | | |
| * | | |
| U AYAKLI YILDIZ SANDALYE 102 | | |
| J | | |
| ø | | |
| 4 ø | | |
| | Ö | f b |

| STAR | | |
|---|---|-----|
|  | | |
| * | | |
| PİRAMİT AYAKLI YILDIZ SANDALYE 103 | | |
| J | | |
| ø | | |
| 4 ø | | |
| | Ö | f b |

| MADİN | | |
|---|---|-----|
|  | | |
| * | | |
| U AYAKLI MADİN SANDALYE 121 | | |
| J | | |
| ø | | |
| 4 ø | | |
| | Ö | f b |

| MADİN | | |
|---|---|-----|
|  | | |
| * | | |
| PİRAMİT AYAKLI MADİN SANDALYE 122 | | |
| J | | |
| ø | | |
| 4 ø | | |
| | Ö | f b |

| SPIDER | | |
|---|---|-----|
|  | | |
| * | | |
| ÖRÜMCEK 271 | | |
| J | | |
| ø | | |
| 4 ø | | |
| | Ö | f b |

| ZİRA | | |
|---|---|-----|
|  | | |
| * | | |
| U AYAKLI KISA ZİRA SANDALYE 141 | | |
| J | | |
| ø | | |
| 4 ø | | |
| | Ö | f b |

| ZİRA | | |
|---|---|-----|
|  | | |
| * | | |
| PİRAMİT AYAKLI KISA ZİRA SANDALYE 142 | | |
| J | | |
| ø | | |
| 4 ø | | |
| | Ö | f b |

| ZİRA | | |
|---|---|-----|
|  | | |
| * | | |
| U AYAKLI UZUN ZİRA SANDALYE 161 | | |
| J | | |
| ø | | |
| 4 ø | | |
| | Ö | f b |

Sandalyeler / Chairs

İç_Dış Mekan / Indoor_Outdoor

Fiyat Listesi / Price List
USD

| ZIRA | | |
|---|---|---|
|  | | |
| * | | |
| PİRAMİT AYAKLI UZUN ZİRA SANDALYE 162 | | |
| J | | |
| ø | | |
| 4 ø | | |
| Ö | f | b |

| CRESCENT | | |
|---|---|---|
|  | | |
| * | | |
| U AYAKLI HİHAL SANDALYE 181 | | |
| J | | |
| ø | | |
| 4 ø | | |
| Ö | f | b |

| PYRAMID | | |
|---|---|---|
|  | | |
| * | | |
| PİRAMİT AYAKLI PİRAMİT SANDALYE 501 | | |
| J | | |
| ø | | |
| 4 ø | | |
| Ö | f | b |

| ÇAMLICA | | |
|---|---|---|
|  | | |
| * | | |
| U AYAKLI ÇAMLICA SANDALYE 521 | | |
| J | | |
| ø | | |
| 4 ø | | |
| Ö | f | b |

| METAL | | |
|---|---|---|
|  | | |
| * | | |
| U AYAKLI METAL SANDALYE 201 | | |
| J | | |
| ø | | |
| 4 ø | | |
| Ö | f | b |

| GANEM | | |
|---|---|---|
|  | | |
| * | | |
| U AYAKLI GANEM SANDALYE 541 | | |
| J | | |
| ø | | |
| 4 ø | | |
| Ö | f | b |

| DOLUNAY | | |
|---|---|---|
|  | | |
| * | | |
| U AYAKLI DOLUNAY SANDALYE 221 | | |
| J | | |
| ø | | |
| 4 ø | | |
| Ö | f | b |

| BEND | | |
|---|---|---|
|  | | |
| * | | |
| U AYAKLI BEND SANDALYE 661 | | |
| J | | |
| ø | | |
| 4 ø | | |
| Ö | f | b |

Sandalyeler / Chairs

İç_Dış Mekan / Indoor_Outdoor

Fiyat Listesi / Price List
USD

| PARL | | |
|---|--|--|
|  | | |
| * | | |
| WO 04 954 | | |
| JA | | |
| Ö f b | | |

| RIVERA | | |
|---|--|--|
|  | | |
| * | | |
| WO 05 955 | | |
| JA | | |
| Ö f b | | |

| KNIGHT | | |
|---|--|--|
|  | | |
| * | | |
| WO 15 965 | | |
| JA | | |
| Ö f b | | |

| MING | | |
|---|--|--|
|  | | |
| * | | |
| WO 07 957 | | |
| øJu | | |
| øJ | | |
| Ö f b | | |

| SALIDA | | |
|---|--|--|
|  | | |
| * | | |
| WO 08 958 | | |
| øJu | | |
| øJ | | |
| Ö f b | | |

| CARVIN | | |
|---|--|--|
|  | | |
| * | | |
| WO 13 963 | | |
| JA | | |
| JAu | | |
| Ö f b | | |

| VERON | | |
|---|--|--|
|  | | |
| * | | |
| WO 02 952 | | |
| øJu | | |
| Ö f b | | |

| HAYWARD | | |
|---|--|--|
|  | | |
| * | | |
| WO 03 953 | | |
| JA | | |
| Ö f b | | |

| PERYY | | |
|---|--|--|
|  | | |
| * | | |
| WO 14 964 | | |
| JA | | |
| Ö f b | | |

Sandalyeler / Chairs

İç_Dış Mekan / Indoor_Outdoor

Fiyat Listesi / Price List
USD

| | | |
|---|--|--|
| CLARA | | |
|  | | |
| * | | |
| WO 17 967 | | |
| JA | | |
| Ö f b | | |

| | | |
|---|--|--|
| CLARA | | |
|  | | |
| * | | |
| WO 18 968 | | |
| JA | | |
| Ö f b | | |

| | | |
|---|--|--|
| COOKIE | | |
|  | | |
| * | | |
| ÖRME SANDALYE 138001 | | |
| JA | | |
| Ö f b | | |

| | | |
|---|--|--|
| BOON | | |
|  | | |
| * | | |
| AKT 08 SANDALYE 6136 | | |
| JA | | |
| Ö f b | | |

| | | |
|---|--|--|
| DINN | | |
|  | | |
| * | | |
| DINN KOLSUZ ÖRME SANDALYE 124011 | | |
| øJ | | |
| øJu | | |
| Ö f b | | |

| | | |
|---|--|--|
| DINN | | |
|  | | |
| * | | |
| DINN KOLLU ÖRME SANDALYE 124002 | | |
| øJ | | |
| øJu | | |
| Ö f b | | |

| | | |
|---|--|--|
| ELIO | | |
|  | | |
| * | | |
| WO 16 966 | | |
| øJ | | |
| Ö f b | | |

| | | |
|---|--|--|
| LATTE | | |
|  | | |
| * | | |
| LATTE ÖRME SANDALYE 980 | | |
| øJ | | |
| Ö f b | | |

| | | |
|---|--|--|
| WAYF | | |
|  | | |
| * | | |
| SEPET OTURUM ÖRME SANDALYE | | |
| øJ | | |
| øJu | | |
| Ö f b | | |

Sandalyeler / Chairs

İç_Dış Mekan / Indoor_Outdoor

Fiyat Listesi / Price List
USD

| FLEX | | |
|---|---|---|
|  | | |
| * | | |
| FLEX 02 131 | | |
| øJ | | |
| | | |
| Ö | f | b |

| ETHNIC | | |
|---|---|---|
|  | | |
| * | | |
| ETNİK 01 151 | | |
| øJ | | |
| | | |
| Ö | f | b |

| ETHNIC | | |
|---|---|---|
|  | | |
| * | | |
| ETNİK 02 152 | | |
| øJ | | |
| | | |
| Ö | f | b |

| PUERTO | | |
|---|---|---|
|  | | |
| * | | |
| WO 06 956 | | |
| øJu | | |
| øJ | | |
| | | |
| Ö | f | b |

| OCTAGON | | |
|---|---|---|
|  | | |
| * | | |
| SEKİZGEN KOLLU SANDALYE 641 | | |
| J | | |
| ø ₁ | | |
| 4 ø | | |
| Ö | f | b |

| OCTAGON | | |
|---|---|---|
|  | | |
| * | | |
| SEKİZGEN KOLSUZ SANDALYE 642 | | |
| J | | |
| ø ₁ | | |
| 4 ø | | |
| Ö | f | b |

| SHARP | | |
|---|---|---|
|  | | |
| * | | |
| SHARP 05 294 | | |
| øJu | | |
| øJ | | |
| | | |
| Ö | f | b |

| SHARP | | |
|---|---|---|
|  | | |
| * | | |
| SHARP 06 297 | | |
| øJu | | |
| øJ | | |
| | | |
| Ö | f | b |

| PEAR | | |
|---|---|---|
|  | | |
| * | | |
| WO 16 966 | | |
| øJu | | |
| øJ | | |
| | | |
| Ö | f | b |

Sandalyeler / Chairs

İç_Dış Mekan / Indoor_Outdoor

Fiyat Listesi / Price List
USD

| CORTADO | | |
|---|--|--|
|  | | |
| * | | |
| WO 09 KOLSUZ 959 | | |
| JA | | |
| SA | | |
| Ö f b | | |

| CORTADO | | |
|---|--|--|
|  | | |
| * | | |
| WO 10 KOLLU 960 | | |
| JA | | |
| SA | | |
| Ö f b | | |

| CORTADO | | |
|---|--|--|
|  | | |
| * | | |
| WO10 KOLLU 960D | | |
| ÖJA | | |
| ÖSA | | |
| Ö f b | | |

| CENDOL | | |
|---|--|--|
|  | | |
| * | | |
| KOLLU RATTAN 6043 | | |
| JA | | |
| SA | | |
| Ö f b | | |

| NORDIC | | |
|---|--|--|
|  | | |
| * | | |
| BAMBU ÖRME SANDALYE 969 | | |
| øJ | | |
| øJu | | |
| Ö f b | | |

| DAISY | | |
|---|--|--|
|  | | |
| * | | |
| BAMBU PAPATYA SANDALYE 970 | | |
| øJ | | |
| øJu | | |
| Ö f b | | |

| NORDIC | | |
|---|--|--|
|  | | |
| * | | |
| BAMBU KOLLU SANDALYE 975 | | |
| øJ | | |
| øJu | | |
| Ö f b | | |

Sandalyeler / Chairs

İç_Dış Mekan / Indoor_Outdoor

Fiyat Listesi / Price List
USD

| | | |
|---|--|--|
|  | | |
| WO 25 975 | | |
| J | | |
| Ö f b | | |

| | | |
|---|--|--|
|  | | |
| ÖRME KLASİK SANDALYE 981 | | |
| J | | |
| Ö f b | | |

| | | |
|---|--|--|
|  | | |
| SALLANIR SANDALYE 981S | | |
| J | | |
| Ö f b | | |

| | | |
|---|--|--|
| ROOK | | |
|  | | |
| * | | |
| WO 11 961 | | |
| JfA | | |
| JoA | | |
| Ö f b | | |

| | | |
|---|--|--|
| ROOK | | |
|  | | |
| * | | |
| WO 12 962 | | |
| JfA | | |
| JoA | | |
| Ö f b | | |

| | | |
|---|--|--|
| ARTEMI | | |
|  | | |
| * | | |
| WO 26 976 | | |
| J | | |
| Ö f b | | |

| | | |
|---|--|--|
| RENZO | | |
|  | | |
| x | | |
| PO 1317 61317 | | |
| u | | |
| Ö f b | | |

Sandalyeler / Chairs

Dış Mekan / Outdoor

Fiyat Listesi / Price List
USD

| MESH | | |
|---|--|--|
|  | | |
| * | | |
| MESH 01K 901K | | |
| өл | | |
| өлү | | |
| Ö f b | | |

| MESH | | |
|---|--|--|
|  | | |
| 0 | | |
| MESH 01 901 | | |
| өл | | |
| өлү | | |
| Ö f b | | |

| MESH | | |
|---|--|--|
|  | | |
| * | | |
| MESH 02 902 | | |
| өл | | |
| өлү | | |
| Ö f b | | |

| MESH | | |
|---|--|--|
|  | | |
| * | | |
| MESH 03 903 | | |
| өл | | |
| өлү | | |
| Ö f b | | |

| MESH | | |
|---|--|--|
|  | | |
| * | | |
| MESH 04 904 | | |
| өл | | |
| өлү | | |
| Ö f b | | |

| MESH | | |
|---|--|--|
|  | | |
| * | | |
| MESH 05 905 | | |
| өл | | |
| өлү | | |
| Ö f b | | |

| MESH | | |
|---|--|--|
|  | | |
| * | | |
| MESH 06 906 | | |
| өл | | |
| өлү | | |
| Ö f b | | |

| MESH | | |
|---|--|--|
|  | | |
| * | | |
| MESH 07 907 | | |
| өл | | |
| өлү | | |
| Ö f b | | |

| MESH | | |
|---|--|--|
|  | | |
| * | | |
| MESH 08 908 | | |
| өл | | |
| өлү | | |
| Ö f b | | |

Sandalyeler / Chairs

Dış Mekan / Outdoor

Fiyat Listesi / Price List
USD

| MESH | | |
|---|--|--|
|  | | |
| * | | |
| MESH 09 909 | | |
| өл | | |
| өлү | | |
| Ö f b | | |

| MESH | | |
|---|--|--|
|  | | |
| * | | |
| MESH 10 910 | | |
| өл | | |
| өлү | | |
| Ö f b | | |

| MESH | | |
|---|--|--|
|  | | |
| * | | |
| MESH 17 917 | | |
| өл | | |
| өлү | | |
| Ö f b | | |

| MESH | | |
|---|--|--|
|  | | |
| * | | |
| MESH 12 921 | | |
| өл | | |
| өлү | | |
| Ö f b | | |

| MESH | | |
|---|--|--|
|  | | |
| * | | |
| MESH 25 925 | | |
| өл | | |
| өлү | | |
| Ö f b | | |

| MESH | | |
|---|--|--|
|  | | |
| * | | |
| MESH 27 927 | | |
| өл | | |
| өлү | | |
| Ö f b | | |

| ESPRESSO | | |
|---|--|--|
|  | | |
| * | | |
| MESH 18 918 | | |
| өл | | |
| өлү | | |
| Ö f b | | |

| ESPRESSO | | |
|---|--|--|
|  | | |
| * | | |
| MESH 19 919 | | |
| өл | | |
| өлү | | |
| Ö f b | | |

| ESPRESSO | | |
|---|--|--|
|  | | |
| * | | |
| MESH 28_1 928_1 | | |
| өл | | |
| өлү | | |
| Ö f b | | |

Sandalyeler / Chairs

Dış Mekan / Outdoor

Fiyat Listesi / Price List
USD

| MERIDIAN | | |
|---|--|--|
|  | | |
| * | | |
| ALÜMİNYUM MERİDYEN SANDALYE 411003 | | |
| øJ | | |
| øJu | | |
| Ö f b | | |

| BETTY | | |
|---|--|--|
|  | | |
| * | | |
| MESH 22 922 | | |
| øJ | | |
| øJu | | |
| Ö f b | | |

| CONROY | | |
|---|--|--|
|  | | |
| * | | |
| MESH 30 930 | | |
| øJ | | |
| øJu | | |
| Ö f b | | |

| SCREAM | | |
|---|--|--|
|  | | |
| * | | |
| MESH 15 915 | | |
| øJ | | |
| øJu | | |
| Ö f b | | |

| SCREAM | | |
|---|--|--|
|  | | |
| * | | |
| MESH 16 916 | | |
| øJ | | |
| øJu | | |
| Ö f b | | |

| WINE | | |
|---|--|--|
|  | | |
| * | | |
| MESH 013 913 | | |
| øJ | | |
| øJu | | |
| Ö f b | | |

Sandalyeler / Chairs

Dış Mekan / Outdoor

Fiyat Listesi / Price List
USD

| LET COND | |
|---|--|
|  | |
| * LET COND SANDALYE 6215 | |
| øJ | |
| øJb | |
| Ö f b | |

| #YOK | |
|---|-----|
|  | |
| * #YOK | |
| DILIMLI SEPET SANDALYE 151005 | |
| øJ | 1 ø |
| øJu | 1 ø |
| 1 ø | |

| HAYWARD | |
|---|--|
|  | |
| * DILIMLI SEPET SANDALYE 151005 | |
| øJ | |
| øJu | |
| Ö f b | |

| FLUTURA | |
|---|--|
|  | |
| * DILIMLI SEPET SANDALYE 151005 | |
| øJ | |
| øJu | |
| Ö f b | |

| DEMILUNE | |
|---|--|
|  | |
| * PA X GÖVDE YARIM AY 6217 | |
| øJu | |
| Ö f b | |

Sandalyeler / Chairs

Dış Mekan / Outdoor

Fiyat Listesi / Price List
USD

| CHAI | | |
|---|--|--|
|  | | |
| x | | |
| KATLANIR SANDALYE 310 | | |
| Öb | | |
| | | |
| Ö f b | | |

| ROBLIN | | |
|---|--|--|
|  | | |
| * | | |
| CMD 19 301 | | |
| өл | | |
| өлү | | |
| | | |
| Ö f b | | |

| CAGE | | |
|---|--|--|
|  | | |
| * | | |
| DIKEY KAFES 621 | | |
| өл | | |
| өлү | | |
| | | |
| Ö f b | | |

| CAGE | | |
|---|--|--|
|  | | |
| * | | |
| YATAY KAFES 622 | | |
| өл | | |
| өлү | | |
| | | |
| Ö f b | | |

| TABBY | | |
|---|--|--|
|  | | |
| * | | |
| TABBY SANDALYE 610 | | |
| өл | | |
| өлү | | |
| | | |
| Ö f b | | |

| FLEX | | |
|---|--|--|
|  | | |
| * | | |
| FLEX 04 133 | | |
| өл | | |
| өлү | | |
| | | |
| Ö f b | | |

| ETHNIC | | |
|---|--|--|
|  | | |
| * | | |
| ETNİK 05 155 | | |
| өл | | |
| өлү | | |
| | | |
| Ö f b | | |

| ETHNIC | | |
|---|--|--|
|  | | |
| * | | |
| ETNİK 04 154 | | |
| өл | | |
| өлү | | |
| | | |
| Ö f b | | |

| JUIST | | |
|---|--|--|
|  | | |
| * | | |
| AKT 07 SANDALYE 5202 | | |
| # | | |
| | | |
| Ö f b | | |

Sandalyeler / Chairs

Dış Mekan / Outdoor

Fiyat Listesi / Price List
USD

| SHARP | | |
|---|--|--|
|  | | |
| * | | |
| SHARP 02 285 | | |
| øJ | | |
| øJu | | |
| Ö f b | | |

| SHARP | | |
|---|--|--|
|  | | |
| * | | |
| SHARP 01 282 | | |
| øJ | | |
| øJu | | |
| Ö f b | | |

| SHARP | | |
|---|--|--|
|  | | |
| * | | |
| SHARP 04 291 | | |
| øJ | | |
| øJu | | |
| Ö f b | | |

| SHARP | | |
|---|--|--|
|  | | |
| * | | |
| SHARP 03 288 | | |
| øJ | | |
| øJu | | |
| Ö f b | | |

| CREY | | |
|---|--|--|
|  | | |
| * | | |
| CMD 14 322 | | |
| øJ | | |
| øJu | | |
| Ö f b | | |

| BOW | | |
|---|--|--|
|  | | |
| * | | |
| CMD 13 321 | | |
| øJ | | |
| øJu | | |
| Ö f b | | |

| COFFE | | |
|---|--|--|
|  | | |
| * | | |
| KOLLU METAL SANDALYE | | |
| øøJ | | |
| øøJu | | |
| Ö f b | | |

| COFFE | | |
|---|--|--|
|  | | |
| * | | |
| KOLSUZ METAL SANDALYE | | |
| øJ | | |
| øJu | | |
| Ö f b | | |

Sandalyeler / Chairs

Dış Mekan / Outdoor

Fiyat Listesi / Price List
USD

| | | |
|---|--|--|
| - | | |
|  | | |
| x | | |
| SEFFAF KOLLU SANDALYE | | |
| | | |
| Ö f b | | |

| | | |
|---|--|--|
| - | | |
|  | | |
| x | | |
| PP SANDALYE | | |
| | | |
| Ö f b | | |

| | | |
|---|--|--|
| - | | |
|  | | |
| x | | |
| KANALLI PP SANDALYE | | |
| | | |
| Ö f b | | |

| | | |
|---|--|--|
| - | | |
|  | | |
| x | | |
| PP KOLTUK | | |
| | | |
| Ö f b | | |

| | | |
|---|--|--|
| - | | |
|  | | |
| x | | |
| PP & AHŞAP AYAK SANDALYE | | |
| | | |
| Ö f b | | |

| | | |
|---|--|--|
| - | | |
|  | | |
| x | | |
| PP SANDALYE | | |
| | | |
| Ö f b | | |

| | | |
|---|--|--|
| - | | |
|  | | |
| x | | |
| PP RATTAN ÖRME KOLTUK | | |
| | | |
| Ö f b | | |

| | | |
|---|--|--|
| - | | |
|  | | |
| x | | |
| PP SANDALYE | | |
| | | |
| Ö f b | | |

Sandalyeler / Chairs

Bank / Benchs

Fiyat Listesi / Price List
USD

| GRAF | | |
|---|--|--|
|  | | |
| * | | |
| HAZERANLI BENCH 6218 | | |
| J | | |
| ø | | |
| Ö f b | | |

| TIANA | | |
|---|--|--|
|  | | |
| * | | |
| NO1 BENCH 704 | | |
| J | | |
| ø | | |
| 4 ø | | |
| Ö f b | | |

| ESTOR | | |
|---|--|--|
|  | | |
| * | | |
| NO3 BENCH 723 | | |
| J | | |
| ø | | |
| 4 ø | | |
| Ö f b | | |

Sandalyeler / Chairs

Banket / Banquette

Fiyat Listesi / Price List
USD

| KARAT | | |
|---|-----|---|
|  | | |
| * | | |
| NO24 767 | | |
| J | | |
| ø | | |
| 4 ø | | |
| | Ö f | b |

| BANJA | | |
|---|-----|---|
|  | | |
| * | | |
| NO25 768 | | |
| J | | |
| ø | | |
| 4 ø | | |
| | Ö f | b |

| CROSS | | |
|---|-----|---|
|  | | |
| * | | |
| ÇAPRAZ AYAKLI 6212 | | |
| J | | |
| ø | | |
| 4 ø | | |
| # | | |
| | Ö f | b |

| LION | | |
|---|-----|---|
|  | | |
| * | | |
| LİON SANDALYE 6350 | | |
| J | | |
| ø | | |
| 4 ø | | |
| | Ö f | b |

Sandalyeler / Chairs

Bar Sandalyesi / Bar Stools

Fiyat Listesi / Price List
USD

| | | |
|---|--|--|
| ANCONA | | |
|  | | |
| x | | |
| PO 037 6237 | | |
| A | | |
| Ö f b | | |

| | | |
|---|--|--|
| SIENA | | |
|  | | |
| x | | |
| PO 038 6238 | | |
| A | | |
| Ö f b | | |

| | | |
|---|--|--|
| PRATO | | |
|  | | |
| x | | |
| PO 039 6239 | | |
| A | | |
| Ö f b | | |

| | | |
|---|--|--|
| BUA | | |
|  | | |
| x | | |
| CS 115 61115 | | |
| A | | |
| Ö f b | | |

| | | |
|---|--|--|
| PAU | | |
|  | | |
| x | | |
| PAU BAR SANDALYESİ 100012 | | |
| A | | |
| Ö f b | | |

| | | |
|---|--|--|
| FORLI | | |
|  | | |
| x | | |
| PO 041 6241 | | |
| A | | |
| Ö f b | | |

| | | |
|---|--|--|
| RUSSI | | |
|  | | |
| x | | |
| PO 042 6242 | | |
| A | | |
| Ö f b | | |

| | | |
|---|--|--|
| PALMA | | |
|  | | |
| x | | |
| PO 505 6505 | | |
| ø | | |
| Ö f b | | |

| | | |
|---|--|--|
| MARIA | | |
|  | | |
| x | | |
| PO 904 6904 | | |
| A | | |
| Ö f b | | |

Sandalyeler / Chairs

Bar Sandalyesi / Bar Stools

Fiyat Listesi / Price List
USD

| HOLLY | |
|---|--|
|  | |
| x | |
| PO 1503 61503 | |
| J | |
| Ø | |
| 4 Ø | |
| | |

| POENA | |
|---|--|
|  | |
| x | |
| PO 272 6272 | |
| A | |
| | |
| Ö f b | |

Sandalyeler / Chairs

Bar Sandalyesi / Bar Stools

Fiyat Listesi / Price List
USD

| ISLAY | | |
|---|--|--|
|  | | |
| x | | |
| CS 037 6135 | | |
| Ö | | |
| Ö f b | | |

| SANNA | | |
|---|--|--|
|  | | |
| x | | |
| CS 036 6136 | | |
| Ö | | |
| Ö f b | | |

| GARRY | | |
|---|--|--|
|  | | |
| x | | |
| CS 045 6145 | | |
| Ö | | |
| Ö f b | | |

| JODI | | |
|---|--|--|
|  | | |
| x | | |
| CS 037 6137 | | |
| Ö | | |
| Ö f b | | |

| JODI | | |
|---|--|--|
|  | | |
| x | | |
| CS 038 6138 | | |
| Ö | | |
| Ö f b | | |

| TOMICH | | |
|---|--|--|
|  | | |
| x | | |
| CS 039 6139 | | |
| Ö | | |
| Ö f b | | |

| TOMICH | | |
|---|--|--|
|  | | |
| x | | |
| CS 040 6140 | | |
| Ö | | |
| Ö f b | | |

| TOMICH | | |
|---|--|--|
|  | | |
| x | | |
| CS 041 6141 | | |
| Ö | | |
| Ö f b | | |

| TOMICH | | |
|---|--|--|
|  | | |
| x | | |
| CS 042 6142 | | |
| Ö | | |
| Ö f b | | |

Sandalyeler / Chairs

Bar Sandalyesi / Bar Stools

Fiyat Listesi / Price List
USD

| WICTON | | |
|---|---------------|--|
|  | | |
| x | CS 044 6144 | |
| Ö | | |
| Ö f b | | |

| WICTON | | |
|---|---------------|--|
|  | | |
| x | CS 043 6143 | |
| Ö | | |
| Ö f b | | |

| DOGA | | |
|---|----------------|--|
|  | | |
| x | CS 108 61108 | |
| | | |
| Ö f b | | |

| FORK | | |
|---|---------------|--|
|  | | |
| x | CS 049 6149 | |
| Ö | | |
| Ö f b | | |

| GARRY | | |
|---|---------------|--|
|  | | |
| x | CS 052 6152 | |
| Ö | | |
| Ö f b | | |

Sandalyeler / Chairs

Bar Sandalyesi / Bar Stools

Fiyat Listesi / Price List
USD

| CAPE | | |
|---|--|--|
|  | | |
| * | | |
| NO16 BAR 753B | | |
| J | | |
| Jø | | |
| J4ø | | |
| Ö f b | | |

| BALLOON | | |
|---|--|--|
|  | | |
| * | | |
| NO17 BAR 756 - MUTFAK 755 | | |
| J | | |
| ø | | |
| 4ø | | |
| Ö f b | | |

| UBON | | |
|---|--|--|
|  | | |
| * | | |
| NO18 BAR 759 - MUTFAK 758 | | |
| J | | |
| ø | | |
| 4ø | | |
| Ö f b | | |

| CERRI | | |
|---|--|--|
|  | | |
| * | | |
| BAR 811 - MUTFAK 810 | | |
| J | | |
| ø | | |
| 4ø | | |
| Ö f b | | |

| SERRA | | |
|---|--|--|
|  | | |
| * | | |
| DÖNER BAR 813 - MUTFAK 812 | | |
| J | | |
| ø | | |
| 4ø# | | |
| Ö f b | | |

| SERRA | | |
|---|--|--|
|  | | |
| * | | |
| ÇİFT BOĞUMLU DÖNER BAR 131001 | | |
| J | | |
| ø | | |
| 4ø# | | |
| Ö f b | | |

| MOLINA | | |
|---|--|--|
|  | | |
| * | | |
| BAR 815 - MUTFAK 814 | | |
| J | | |
| ø | | |
| 4ø# | | |
| Ö f b | | |

| CORTE | | |
|---|--|--|
|  | | |
| * | | |
| BAR 817 - MUTFAK 816 | | |
| J | | |
| ø | | |
| 4ø# | | |
| Ö f b | | |

| PARDI | | |
|---|--|--|
|  | | |
| * | | |
| BAR 821 - MUTFAK 820 | | |
| J | | |
| ø | | |
| 4ø# | | |
| Ö f b | | |

Sandalyeler / Chairs

Bar Sandalyesi / Bar Stools

Fiyat Listesi / Price List
USD

| POLDE | | |
|---|-----|---|
|  | | |
| * | | |
| BAR 824 | | |
| J | | |
| ø ₁ | | |
| 4 ø | | |
| | Ö f | b |

| ORTON | | |
|---|-----|---|
|  | | |
| X | | |
| PO 040 6240 | | |
| A | | |
| | | |
| | Ö f | b |

| DIANA | | |
|---|-----|---|
|  | | |
| * | | |
| BAR 823 - MUTFAK 822 | | |
| J | | |
| ø ₁ | | |
| 4 ø# | | |
| | Ö f | b |

| TUNAS | | |
|---|-----|---|
|  | | |
| * | | |
| NO2 BAR 713 - MUTFAK 714 | | |
| J | | |
| ø ₁ | | |
| 4 ø | | |
| | Ö f | b |

| SUN | | |
|---|-----|---|
|  | | |
| * | | |
| GÜNEŞ BAR 632 - MUTFAK 631 | | |
| J | | |
| ø ₁ | | |
| 4 ø | | |
| | Ö f | b |

| PETI | | |
|---|-----|---|
|  | | |
| * | | |
| NO19 BAR 762 - MUTFAK 761 | | |
| J | | |
| ø ₁ | | |
| 4 ø | | |
| | Ö f | b |

| GRAF | | |
|---|-----|---|
|  | | |
| * | | |
| KOLSUZ HAZERANLI BAR 683 - MUTFAK 682 | | |
| J | | |
| ø ₁ | | |
| 4 ø | | |
| | Ö f | b |

| GRAF | | |
|---|-----|---|
|  | | |
| * | | |
| KOLLU HAZERANLI BAR 686 - MUTFAK 685 | | |
| J | | |
| ø ₁ | | |
| 4 ø | | |
| | Ö f | b |

| MERIDA | | |
|---|-----|---|
|  | | |
| * | | |
| GRM ÜÇGEN BAR SANDALYESİ 148001 | | |
| # | | |
| # | | |
| | Ö f | b |

Sandalyeler / Chairs

Bar Sandalyesi / Bar Stools

Fiyat Listesi / Price List
USD

| MADIN | | |
|---|--|--|
|  | | |
| * | | |
| AKLI MADIN BAR 124 | | |
| J | | |
| ø | | |
| 4 ø | | |
| Ö f b | | |

| ZIRA | | |
|---|--|--|
|  | | |
| * | | |
| AHŞAP AYAKLI KISA ZİRA BAR 146 | | |
| J | | |
| ø | | |
| 4 ø | | |
| Ö f b | | |

| DOLUNAY | | |
|---|--|--|
|  | | |
| * | | |
| AHŞAP AYAKLI DOLUNAY BAR 226 | | |
| J | | |
| ø | | |
| 4 ø | | |
| Ö f b | | |

| BEND | | |
|---|--|--|
|  | | |
| * | | |
| AHŞAP AYAKLI BEND BAR 664 | | |
| J | | |
| ø | | |
| 4 ø | | |
| Ö f b | | |

| FORCI | | |
|---|--|--|
|  | | |
| * | | |
| A 013 6313 | | |
| | | |
| Ö f b | | |

| TORRE | | |
|---|--|--|
|  | | |
| * | | |
| A 012 6312 | | |
| | | |
| Ö f b | | |

| DOLUNAY | | |
|---|--|--|
|  | | |
| * | | |
| DOLUNAY BAR TABURE 224 | | |
| J | | |
| ø | | |
| 4 ø | | |
| Ö f | | |

| BASKET | | |
|---|--|--|
|  | | |
| * | | |
| POTA BAR TABURESİ 564 - MUTFAK 565 | | |
| J | | |
| ø | | |
| 4 ø | | |
| Ö f | | |

| LIU | | |
|---|--|--|
|  | | |
| * | | |
| FN BAR SANDALYESİ 107016 | | |
| øJ | | |
| øJu | | |
| Ö f | | |

Sandalyeler / Chairs

Bar Sandalyesi / Bar Stools

Fiyat Listesi / Price List
USD

| OCTAGON | | |
|---|--|--|
|  | | |
| * | | |
| SEKİZGEN BAR 644 | | |
| øJ | | |
| øJu | | |
| Ö f b | | |

| ESPRESSO | | |
|---|--|--|
|  | | |
| * | | |
| MESH 012 912 | | |
| øJ | | |
| øJu | | |
| Ö f b | | |

| WINE | | |
|---|--|--|
|  | | |
| * | | |
| MESH 14 914 | | |
| øJ | | |
| øJu | | |
| Ö f b | | |

| MESH | | |
|---|--|--|
|  | | |
| * | | |
| MESH 20 BAR 920 | | |
| øJ | | |
| øJu | | |
| Ö f b | | |

| MESH | | |
|---|--|--|
|  | | |
| * | | |
| MESH 24 BAR 924 | | |
| øJ | | |
| øJu | | |
| Ö f b | | |

| SHARP | | |
|---|--|--|
|  | | |
| * | | |
| SHARP 01 BAR 284 - MUTFAK 283 | | |
| øJ | | |
| øJu | | |
| Ö f b | | |

| SHARP | | |
|--|--|--|
| Ø | | |
| * | | |
| SHARP 02 BAR 287 - MUTFAK 286 | | |
| øJ | | |
| øJu | | |
| Ö f b | | |

| SHARP | | |
|--|--|--|
| Ø | | |
| * | | |
| SHARP 03 BAR 290 - MUTFAK 289 | | |
| øJ | | |
| øJu | | |
| Ö f b | | |

| CORTADO | | |
|---|--|--|
|  | | |
| * | | |
| RATTAN KOLSUZ BAR 6011 | | |
| JA | | |
| SA | | |
| Ö f b | | |

Sandalyeler / Chairs

Bar Sandalyesi / Bar Stools

Fiyat Listesi / Price List
USD

| SHARP | | |
|--|--|--|
| Ø | | |
| * | | |
| SHARP 04 BAR 293 - MUTFAK 292 | | |
| øJ | | |
| øJu | | |
| Ö f b | | |

| SHARP | | |
|--|--|--|
| Ø | | |
| * | | |
| SHARP 05 BAR 296 - MUTFAK 295 | | |
| øJ | | |
| øJu | | |
| Ö f b | | |

| SHARP | | |
|--|--|--|
| Ø | | |
| * | | |
| SHARP 06 BAR 299 - MUTFAK 298 | | |
| øJ | | |
| øJu | | |
| Ö f b | | |

| PRETA | | |
|---|--|--|
|  | | |
| * | | |
| BAR 819 | | |
| J | | |
| øJu | | |
| Ö f | | |

| DINN | | |
|---|--|--|
|  | | |
| * | | |
| DINN ÖRME BAR SANDALYESİ 124005 | | |
| øJ | | |
| øJu | | |
| Ö f | | |

| PARL | | |
|---|--|--|
|  | | |
| * | | |
| WO 04 BAR 6129 | | |
| JA | | |
| Ö f b | | |

| DINN | | |
|---|--|--|
|  | | |
| * | | |
| DINN SAC BAR SANDALYESİ 912404 | | |
| øJ | | |
| øJu | | |
| Ö f | | |

| NORDIC | | |
|---|--|--|
|  | | |
| * | | |
| BAMBU ÖRME BAR 972 | | |
| øJ | | |
| øJu | | |
| Ö f b | | |

| SPIDER | | |
|--------------------------|--|--|
| Ø | | |
| * | | |
| ÖRÜMCEK BAR 273 | | |
| J | | |
| ø ₄ | | |
| Ö f | | |

Sandalyeler / Chairs

Bar Sandalyesi / Bar Stools

Fiyat Listesi / Price List
USD

| STAR | | |
|---|--|--|
|  | | |
| * | | |
| PİRAMİT AYAKLI YILDIZ BAR 105 | | |
| J | | |
| ø | | |
| 4 ø | | |
| Ö f | | |

| STAR | | |
|---|--|--|
|  | | |
| * | | |
| U AYAKLI YILDIZ BAR 106 | | |
| J | | |
| ø | | |
| 4 ø | | |
| Ö f | | |

| ZIRA | | |
|---|--|--|
|  | | |
| * | | |
| U AYAKLI KISA ZIRA BAR 145 | | |
| J | | |
| ø | | |
| 4 ø | | |
| Ö f | | |

| ÇAMLIÇA | | |
|---|--|--|
|  | | |
| * | | |
| U AYAKLI ÇAMLIÇA BAR 523 | | |
| J | | |
| ø | | |
| 4 ø | | |
| Ö f | | |

| METAL | | |
|---|--|--|
|  | | |
| * | | |
| U AYAKLI METAL BAR 203 | | |
| J | | |
| ø | | |
| 4 ø | | |
| Ö f | | |

| WIRE | | |
|---|--|--|
|  | | |
| * | | |
| PİRAMİT AYAKLI TEL BAR 242 - MUTFAK 244 | | |
| J | | |
| ø | | |
| 4 ø | | |
| Ö f | | |

| DOLUNAY | | |
|---|--|--|
|  | | |
| * | | |
| U AYAKLI DOLUNAY BAR 225 | | |
| J | | |
| ø | | |
| 4 ø | | |
| Ö f | | |

| BEND | | |
|---|--|--|
|  | | |
| * | | |
| U AYAKLI BEND BAR 663 | | |
| J | | |
| ø | | |
| 4 ø | | |
| Ö f | | |

| WIRE | | |
|---|--|--|
|  | | |
| * | | |
| U AYAKLI TEL BAR 241 - MUTFAK 243 | | |
| J | | |
| ø | | |
| 4 ø | | |
| Ö f | | |

Sandalyeler / Chairs

Tabure / Stools

Fiyat Listesi / Price List
USD

| TWING | | |
|---|--|--|
|  | | |
| x | | |
| CS 402 6402 | | |
| J | | |
| Ö f b | | |

| PETRI | | |
|---|--|--|
|  | | |
| x | | |
| CS 405 6405 | | |
| J | | |
| Ö f b | | |

| BANF | | |
|---|--|--|
|  | | |
| x | | |
| CS 407 6407 | | |
| J | | |
| Ö f b | | |

| BANF | | |
|---|--|--|
|  | | |
| x | | |
| CS 411 6411 | | |
| J | | |
| Ö f b | | |

| BANF | | |
|---|--|--|
|  | | |
| x | | |
| CS 414 6414 | | |
| J | | |
| Ö f b | | |

| TABOO | | |
|---|--|--|
|  | | |
| x | | |
| CS 401 6401 | | |
| J | | |
| Ö f b | | |

| BARU | | |
|---|--|--|
|  | | |
| x | | |
| CS 418 6418 | | |
| J | | |
| Ö f b | | |

Sandalyeler / Chairs

Tabure / Stools

Fiyat Listesi / Price List
USD

| STAR | | |
|---|-----|---|
|  | | |
| * | | |
| YILDIZ TABURE 109 | | |
| J | | |
| ø | | |
| 4 ø | | |
| | Ö f | b |

| DOLUNAY | | |
|---|-----|---|
|  | | |
| * | | |
| DOLUNAY TABURE 223 | | |
| J | | |
| ø | | |
| 4 ø | | |
| | Ö f | b |

| BASKET | | |
|---|-----|---|
|  | | |
| * | | |
| POTA TABURE 561 | | |
| J | | |
| ø | | |
| 4 ø | | |
| | Ö f | b |

| CUP | | |
|---|-----|---|
|  | | |
| * | | |
| KUPA TABURE 583 | | |
| J | | |
| ø | | |
| 4 ø | | |
| | Ö f | b |

| TIANA | | |
|---|-----|---|
|  | | |
| * | | |
| NO1 TABURE 703 | | |
| J | | |
| ø | | |
| 4 ø | | |
| | Ö f | b |

| ESPRESSO | | |
|---|-----|---|
|  | | |
| * | | |
| MESH 26 TABURE 926 | | |
| øJ | | |
| øJu | | |
| | Ö f | b |

| GRAF | | |
|---|-----|---|
|  | | |
| * | | |
| HAZARANLI TABURE 688 | | |
| J | | |
| ø | | |
| | Ö f | b |

| GRAF | | |
|---|-----|---|
|  | | |
| * | | |
| HAZARANLI SIRTLI TABURE 689 | | |
| J | | |
| ø | | |
| | Ö f | b |

| OCTAGON | | |
|---|-----|---|
|  | | |
| * | | |
| SEKİZGEN ŞEZLONG TABURESİ 89 | | |
| øJ | | |
| | Ö f | b |

Sandalyeler / Chairs

Tabure / Stools

Fiyat Listesi / Price List
USD

| FOXY | | |
|---|--|--|
|  | | |
| x | | |
| PO 855 6855 | | |
| q | | |
| Ö f b | | |

| BARU | | |
|---|--|--|
|  | | |
| x | | |
| CS 417 6417 | | |
| J | | |
| Ö f b | | |

| TABOO | | |
|---|--|--|
|  | | |
| x | | |
| CS 416 6416 | | |
| J | | |
| Ö f b | | |

Oturma Grupları / Seating Groups

Berjer / Seat

Fiyat Listesi / Price List
USD

| LUENA | | |
|---|--|--|
|  | | |
| x | | |
| PO 951 6951 | | |
| ü | | |
| Ö f b | | |

| LUENA | | |
|---|--|--|
|  | | |
| x | | |
| PO 951 6951 | | |
| #ü | | |
| Ö f b | | |

| WAIST | | |
|---|--|--|
|  | | |
| x | | |
| PO 953 6953 | | |
| ü | | |
| Ö f b | | |

| MAMBA | | |
|---|--|--|
|  | | |
| x | | |
| PO 952 6952 | | |
| ü | | |
| Ö f b | | |

| MAMBA | | |
|---|--|--|
|  | | |
| x | | |
| PO 952 6952 | | |
| #ü | | |
| Ö f b | | |

| LIDA | | |
|---|--|--|
|  | | |
| x | | |
| PO 956 6956 | | |
| ü | | |
| Ö f b | | |

| MUNGO | | |
|---|--|--|
|  | | |
| x | | |
| PO 954 6954 | | |
| ü | | |
| Ö f b | | |

| MUNGO | | |
|---|--|--|
|  | | |
| x | | |
| PO 954 6954 | | |
| #ü | | |
| Ö f b | | |

| KOLNO | | |
|---|--|--|
|  | | |
| x | | |
| PO 957 6957 | | |
| ü | | |
| Ö f b | | |

Oturma Grupları / Seating Groups

Berjer / Seat

Fiyat Listesi / Price List
USD

| CANDALA | | |
|---|--|--|
|  | | |
| x | | |
| PO 955 6955 | | |
| ü | | |
| Ö f b | | |

| CANDALA | | |
|---|--|--|
|  | | |
| x | | |
| PO 955 6955 | | |
| #ü | | |
| Ö f b | | |

| TEO | | |
|---|--|--|
|  | | |
| x | | |
| PO 972 6972 | | |
| ü | | |
| Ö f b | | |

| TEO | | |
|---|--|--|
|  | | |
| x | | |
| PO 971 6971 | | |
| ü | | |
| Ö f b | | |

| TEO | | |
|---|--|--|
|  | | |
| x | | |
| PO 971 6971 | | |
| ü | | |
| Ö f b | | |

| MAJESTY | | |
|---|--|--|
|  | | |
| x | | |
| PO 806 6806 | | |
| ü | | |
| Ö f b | | |

| RAAHE | | |
|---|--|--|
|  | | |
| x | | |
| PO 959 6959 | | |
| ü | | |
| Ö f b | | |

| RUKA | | |
|---|--|--|
|  | | |
| x | | |
| PO 960 6960 | | |
| ü | | |
| Ö f b | | |

| PLOCK | | |
|---|--|--|
|  | | |
| x | | |
| PO 958 6958 | | |
| ü | | |
| Ö f b | | |

Oturma Grupları / Seating Groups

Berjer / Seat

Fiyat Listesi / Price List
USD

| BODEN | | |
|---|--|--|
|  | | |
| x | | |
| PO 043 6243 | | |
| A | | |
| | | |
| Ö f b | | |

| HULL | | |
|---|--|--|
|  | | |
| x | | |
| PO 805 6805 | | |
| | | |
| | | |
| Ö f b | | |

| BODEN | | |
|---|--|--|
|  | | |
| x | | |
| PO 052 6252 | | |
| A | | |
| | | |
| Ö f b | | |

| MALM | | |
|---|--|--|
|  | | |
| x | | |
| PO 048 6248 | | |
| A | | |
| | | |
| Ö f b | | |

| POLMEN | | |
|---|--|--|
|  | | |
| x | | |
| PO 961 6961 | | |
| ü | | |
| | | |
| Ö f b | | |

| ALBERTA | | |
|---|--|--|
|  | | |
| x | | |
| PO 969 6969 | | |
| ü | | |
| | | |
| Ö f b | | |

| KRISTEN | | |
|---|--|--|
|  | | |
| x | | |
| PO 614 6614 | | |
| | | |
| | | |
| Ö f b | | |

| HOLM | | |
|---|--|--|
|  | | |
| x | | |
| PO 049 6249 | | |
| AÖ | | |
| AÖ | | |
| | | |
| Ö f b | | |

| RUBBLE | | |
|---|--|--|
|  | | |
| x | | |
| PO 754 6754 - BERJER | | |
| | | |
| | | |
| Ö f b | | |

Oturma Grupları / Seating Groups

Berjer / Seat

Fiyat Listesi / Price List
USD

| | | |
|---|--|--|
| DANTE | | |
|  | | |
| x | | |
| PO 065 6265 - BERJER | | |
| AÖÖ | | |
| AÖø | | |
| Ö f b | | |

| | | |
|---|--|--|
| LILY | | |
|  | | |
| x | | |
| PO 854 6854 | | |
| q | | |
| Ö f b | | |

| | | |
|---|--|--|
| ANVERS | | |
|  | | |
| x | | |
| PO 801 6801 | | |
| | | |
| Ö f b | | |

| | | |
|---|--|--|
| FOXY | | |
|  | | |
| x | | |
| PO 853 6853 | | |
| q | | |
| Ö f b | | |

| | | |
|---|--|--|
| DUVE | | |
|  | | |
| x | | |
| PO 601 6601 | | |
| | | |
| Ö f b | | |

| | | |
|---|--|--|
| MORRIS | | |
|  | | |
| x | | |
| PO 1402 61402 | | |
| Jø | | |
| Ö f b | | |

| | | |
|---|--|--|
| TENBY | | |
|  | | |
| x | | |
| PO 706 6706 | | |
| S | | |
| Ö f b | | |

| | | |
|---|--|--|
| - | | |
|  | | |
| x | | |
| A 008 6308 | | |
| | | |

| | | |
|---|--|--|
| - | | |
|  | | |
| x | | |
| A 011 6311 | | |
| | | |

Oturma Grupları / Seating Groups

Berjer / Seat

Fiyat Listesi / Price List
USD

| SALEN | | |
|---|---------------|--|
|  | | |
| x | PO 045 6245 | |
| A | | |
| Ö f b | | |

| BRUNO | | |
|---|---------------|--|
|  | | |
| x | PO 973 6973 | |
| ü | | |
| Ö f b | | |

| EMBRA | | |
|---|--------------|--|
|  | | |
| x | EMBRA BERJER | |
| | | |
| Ö f b | | |

| BEGONIA | | |
|---|---------------|--|
|  | | |
| x | PO 351 / 6351 | |
| # | | |
| Ö f b | | |

Oturma Grupları / Seating Groups

Berjer / Seat

Fiyat Listesi / Price List
USD

| METAL | | |
|---|---|-----|
|  | | |
| * | | |
| METAL KOLTUK 206 | | |
| J | | |
| ø | | |
| 4 ø | | |
| | Ö | f b |

| CAFTAN | | |
|---|---|-----|
|  | | |
| * | | |
| KAFTAN 550 | | |
| J | | |
| ø | | |
| 4 ø | | |
| | Ö | f b |

| PEACOCK | | |
|---|---|-----|
|  | | |
| * | | |
| TAVUS KOLTUK 551 | | |
| J | | |
| ø | | |
| 4 ø | | |
| | Ö | f b |

| CUP | | |
|---|---|-----|
|  | | |
| * | | |
| KUPA BERJER 581 | | |
| J | | |
| ø | | |
| 4 ø | | |
| | Ö | f b |

| RAUND | | |
|---|---|-----|
|  | | |
| * | | |
| NO2 BERJER 712 | | |
| J | | |
| ø | | |
| 4 ø | | |
| | Ö | f b |

| TUENA | | |
|---|---|-----|
|  | | |
| * | | |
| NO15 BERJER 751 | | |
| J | | |
| ø | | |
| 4 ø | | |
| | Ö | f b |

| CAEN | | |
|---|---|-----|
|  | | |
| * | | |
| NO5 731 | | |
| J | | |
| ø | | |
| 4 ø | | |
| | Ö | f b |

| CAEN | | |
|---|---|-----|
|  | | |
| * | | |
| NO6 732 | | |
| J | | |
| ø | | |
| 4 ø | | |
| | Ö | f b |

| MOCA | | |
|---|---|-----|
|  | | |
| * | | |
| ÖZEL MODEL BERJER 772 | | |
| J | | |
| ø | | |
| 4 ø | | |
| | Ö | f b |

Oturma Grupları / Seating Groups

Berjer / Seat

Fiyat Listesi / Price List
USD

| OUDDORP | | |
|---|--|--|
|  | | |
| * | | |
| AKT 02 BERJER 1021 | | |
| JA | | |
| Ö f b | | |

| PARALIA | | |
|---|--|--|
|  | | |
| * | | |
| AKT3 BERJER 1041 | | |
| JA | | |
| Ö f b | | |

| CARVIN | | |
|---|--|--|
|  | | |
| * | | |
| AKT4 BERJER 1061 | | |
| JA | | |
| Ö f b | | |

| NORD | | |
|---|--|--|
|  | | |
| * | | |
| AKT 05 BERJER 1081 | | |
| JA | | |
| Ö f b | | |

| CLARA | | |
|---|--|--|
|  | | |
| * | | |
| AKT 06 BERJER 1100 | | |
| JA | | |
| Ö f b | | |

| BOON | | |
|---|--|--|
|  | | |
| * | | |
| AKT 08 BERJER 6135 | | |
| JA | | |
| Ö f b | | |

| PTN | | |
|---|--|--|
|  | | |
| * | | |
| PTN KOLTUK 6113 | | |
| J | | |
| øJ | | |
| Ö f b | | |

| PTN | | |
|---|--|--|
|  | | |
| * | | |
| PTN SIRTLI KOLTUK 6113S | | |
| J | | |
| øJ | | |
| Ö f b | | |

| DAISY | | |
|---|--|--|
|  | | |
| * | | |
| BAMBU PAPATYA BERJER 971 | | |
| øJu | | |
| Ö f b | | |

Oturma Grupları / Seating Groups

Berjer / Seat

Fiyat Listesi / Price List
USD

| TABBY | | |
|---|--|--|
|  | | |
| * | | |
| TABBY BERJER 611 | | |
| øJ | | |
| øJu | | |
| Ö f b | | |

| OCTAGON | | |
|---|--|--|
|  | | |
| * | | |
| SEKİZGEN BERJER 643 | | |
| J | | |
| ø_ | | |
| 4 ø | | |
| Ö f b | | |

| OCTAGON | | |
|---|--|--|
|  | | |
| * | | |
| DEMONTE SEKİZGEN BERJER 648 | | |
| øJ | | |
| Ö f b | | |

| STAINLESS | | |
|---|--|--|
|  | | |
| * | | |
| PASLANMAZ KOLTUK 324 | | |
| # | | |
| Ö f b | | |

| DELOS | | |
|---|--|--|
|  | | |
| * | | |
| AKT 01 BERJER 1001 | | |
| JA | | |
| Ö f b | | |

| KNIGHT | | |
|---|--|--|
|  | | |
| * | | |
| WO 15 BERJER TEKL 977 | | |
| JA | | |
| Ö f b | | |

| QUEEN | | |
|---|--|--|
|  | | |
| * | | |
| WO 27 6109 | | |
| JA | | |
| Ö f b | | |

| ESPRESSO | | |
|---|--|--|
|  | | |
| * | | |
| MESH 028 928 | | |
| øJ | | |
| øJu | | |
| Ö f b | | |

| ESPRESSO | | |
|---|--|--|
|  | | |
| * | | |
| MESH 011 911 | | |
| øJ | | |
| øJu | | |
| Ö f b | | |

Oturma Grupları / Seating Groups

Berjer / Seat

Fiyat Listesi / Price List
USD

| ŞARM | | |
|---|---|---|
|  | | |
| * | | |
| AKT 09 KOLTUK 1081 | | |
| J4 ø# | | |
| | | |
| Ö | f | b |

| BUTTERFLY | | |
|---|---|---|
|  | | |
| * | | |
| AKT 10 BERJER 6140 | | |
| JA | | |
| | | |
| Ö | f | b |

| BUTTERFLY | | |
|---|---|---|
|  | | |
| * | | |
| AKT 10 ÇİFTLİ 6141 | | |
| JA | | |
| | | |
| Ö | f | b |

| KING | | |
|---|---|---|
|  | | |
| * | | |
| ÖRME UZUN SIRTLI BERJER 6317 | | |
| JA | | |
| | | |
| Ö | f | b |

| KING | | |
|---|---|---|
|  | | |
| * | | |
| ÖRME UZUN SIRTLI BERJER 6317 | | |
| JA | | |
| | | |
| Ö | f | b |

| HOOKAH | | |
|---|---|---|
|  | | |
| * | | |
| HOOKAH BERJER 100009 | | |
| JA | | |
| | | |
| Ö | f | b |

| OCTAGON | | |
|---|---|---|
|  | | |
| * | | |
| SEKİZGEN KOLLU BERJER 93 | | |
| øJ | | |
| | | |
| Ö | f | b |

| NORDIC | | |
|---|---|---|
|  | | |
| * | | |
| BAMBU ŞEZLONG 973 | | |
| øJ | | |
| øJu | | |
| | | |
| Ö | f | b |

| TRIANGLE | | |
|---|---|---|
|  | | |
| * | | |
| WO 01 951 | | |
| øJ | | |
| øJu | | |
| | | |
| Ö | f | b |

Oturma Grupları / Seating Groups

Berjer / Seat

Fiyat Listesi / Price List
USD

| P ARM | |
|---|--|
|  | |
| * | |
| FİLELİ KOLTUK 107009 | |
| ø | |
| Ö f b | |

Oturma Grupları / Seating Groups

Berjer / Seat

Fiyat Listesi / Price List
USD

| VARDE | | |
|---|--|--|
|  | | |
| x | | |
| VARDE TEKLI 1201 | | |
| f h | | |
| | | |
| o f b | | |

| SALY | | |
|---|--|--|
|  | | |
| x | | |
| SALY TEKLI 1211 | | |
| f h | | |
| | | |
| o f b | | |

| MOON | | |
|---|--|--|
|  | | |
| x | | |
| MOON BERJER 1311 | | |
| f h | | |
| | | |
| o f b | | |

| CRES | | |
|---|--|--|
|  | | |
| x | | |
| CRES BERJER 1312 | | |
| f h | | |
| | | |
| o f b | | |

Oturma Grupları / Seating Groups

Sedirler/ Sofas

Fiyat Listesi / Price List
USD

| HOLTE | | |
|---|--|--|
|  | | |
| x | | |
| PO 053 6253 | | |
| A | | |
| Ö f b | | |

| BOOST | | |
|---|--|--|
|  | | |
| x | | |
| PO 054 6254 | | |
| A | | |
| Ö f b | | |

| SPLIT | | |
|---|--|--|
|  | | |
| x | | |
| PO 055 6255 | | |
| A | | |
| Ö f b | | |

| BERT | | |
|---|--|--|
|  | | |
| x | | |
| PO 056 6256 | | |
| A | | |
| Ö f b | | |

| CHESTER | | |
|---|--|--|
|  | | |
| x | | |
| PO 057 6257 | | |
| A | | |
| Ö f b | | |

| NORBA | | |
|---|--|--|
|  | | |
| x | | |
| PO 058 6258 | | |
| A | | |
| Ö f b | | |

| HOLTE | | |
|---|--|--|
|  | | |
| x | | |
| PO 059 6259 | | |
| A | | |
| Ö f b | | |

| CAROLINE | | |
|---|--|--|
|  | | |
| x | | |
| PO 060 6260 | | |
| A | | |
| Ö f b | | |

| CALINA | | |
|---|--|--|
|  | | |
| x | | |
| PO 061 6261 | | |
| A | | |
| Ö f b | | |

Oturma Grupları / Seating Groups

Sedirler/ Sofas

Fiyat Listesi / Price List
USD

| ATRA | | |
|---|--|--|
|  | | |
| x | | |
| PO 062 6262 | | |
| A | | |
| Ö f b | | |

| RIPE SOFA | | |
|---|--|--|
|  | | |
| x | | |
| PO 063 6263 | | |
| A | | |
| Ö f b | | |

| DANTE | | |
|---|--|--|
|  | | |
| x | | |
| PO 064 6264 - SEDIR | | |
| AÖÖ | | |
| AÖø | | |
| Ö f b | | |

| ADOLF | | |
|--|--|--|
|  | | |
| x | | |
| PO 073 6273 | | |
| A | | |
| Ö f b | | |

| REM | | |
|---|----|--|
|  | | |
| x | | |
| PO 1315 61315 | | |
| u | Ku | |
| Ö f b | | |

| LEOH | | |
|---|----|--|
|  | | |
| x | | |
| PO 1316 61316 - BAZALI SEDIR | | |
| u | Ku | |
| Ö f b | | |

Oturma Grupları / Seating Groups

Sedirler/ Sofas

Fiyat Listesi / Price List
USD

| | | |
|---|--|--|
| LEO | | |
|  | | |
| * | | |
| PO 2001 | | |
| N | | |
| Ö f b | | |

| | | |
|---|--|--|
| MIA | | |
|  | | |
| * | | |
| PO 2002 | | |
| N | | |
| Ö f b | | |

| | | |
|---|--|--|
| DIVA | | |
|  | | |
| * | | |
| PO 2003 | | |
| N | | |
| Ö f b | | |

| | | |
|---|--|--|
| YASY | | |
|  | | |
| * | | |
| PO 2004 | | |
| N | | |
| Ö f b | | |

| | | |
|---|--|--|
| OZZY | | |
|  | | |
| * | | |
| PO 2005 | | |
| N | | |
| Ö f b | | |

| | | |
|---|--|--|
| CLASIC | | |
|  | | |
| * | | |
| PO 2006 | | |
| N | | |
| Ö f b | | |

| | | |
|---|--|--|
| YUMMY | | |
|  | | |
| * | | |
| PO 2005 | | |
| N | | |
| Ö f b | | |

| | | |
|---|--|--|
| MOD | | |
|  | | |
| * | | |
| PO 2010 | | |
| N | | |
| Ö f b | | |

Oturma Grupları / Seating Groups

Sedirler/ Sofas

Fiyat Listesi / Price List
USD

| KNIGHT | | |
|---|--|--|
|  | | |
| * | | |
| WO 15 İKİLİ KOLTUK 978 | | |
| JA | | |
| Ö f b | | |

| KNIGHT | | |
|---|--|--|
|  | | |
| * | | |
| WO 15 ÜÇLÜ KOLTUK 979 | | |
| JA | | |
| Ö f b | | |

| DELOS | | |
|---|--|--|
|  | | |
| * | | |
| AKT 01 ÇİFTLİ 1002 | | |
| JA | | |
| Ö f b | | |

| DELOS | | |
|---|--|--|
|  | | |
| * | | |
| AKT 01 ÜÇLÜ 1003 | | |
| JA | | |
| Ö f b | | |

| OUDDORP | | |
|---|--|--|
|  | | |
| * | | |
| AKT 02 ÇİFTLİ 1022 | | |
| JA | | |
| Ö f b | | |

| NORD | | |
|---|--|--|
|  | | |
| * | | |
| AKT 05 ÜÇLÜ 1083 | | |
| JA | | |
| Ö f b | | |

| CARVIN | | |
|---|--|--|
|  | | |
| * | | |
| AKT4 ÇİFTLİ 1062 | | |
| JA | | |
| Ö f b | | |

| CARVIN | | |
|---|--|--|
|  | | |
| * | | |
| AKT4 ÜÇLÜ 1063 | | |
| JA | | |
| Ö f b | | |

| NORD | | |
|---|--|--|
|  | | |
| * | | |
| AKT 05 ÇİFTLİ 1082 | | |
| JA | | |
| Ö f b | | |

Oturma Grupları / Seating Groups

Sedirler/ Sofas

Fiyat Listesi / Price List
USD

| NORD | | |
|---|--|--|
|  | | |
| * | | |
| AKT 05 ÜÇLÜ 1083 | | |
| JA | | |
| Ö f b | | |

| CLARA | | |
|---|--|--|
|  | | |
| * | | |
| AKT 06 ÇİFTLİ 1101 | | |
| JA | | |
| Ö f b | | |

| CLARA | | |
|---|--|--|
|  | | |
| * | | |
| AKT 06 ÜÇLÜ 1102 | | |
| JA | | |
| Ö f b | | |

| BOON | | |
|---|--|--|
|  | | |
| * | | |
| AKT 08 ÇİFTLİ 6133 | | |
| JA | | |
| Ö f b | | |

| BOON | | |
|--------------------|--|--|
| Ø | | |
| * | | |
| AKT 08 ÜÇLÜ 6134 | | |
| JA | | |
| Ö f b | | |

| PTN | | |
|---|--|--|
|  | | |
| * | | |
| PTN ÇİFTLİ 6114 | | |
| J | | |
| øJ | | |
| Ö f b | | |

| PTN | | |
|-----------------|--|--|
| Ø | | |
| * | | |
| PTN ÜÇLÜ 6115 | | |
| J | | |
| øJ | | |
| Ö f b | | |

| PTN | | |
|---|--|--|
|  | | |
| * | | |
| PTN SIRTLI ÇİFTLİ 6114S | | |
| J | | |
| øJ | | |
| Ö f b | | |

| PARALIA | | |
|---|--|--|
|  | | |
| * | | |
| AKT3 ÇİFTLİ 1042 | | |
| JA | | |
| Ö f b | | |

Oturma Grupları / Seating Groups

Sedirler/ Sofas

Fiyat Listesi / Price List
USD

| ESPRESSO | | |
|---|--|--|
|  | | |
| * | | |
| MESH 049 949 | | |
| øJ | | |
| øJu | | |
| Ö f b | | |

| VARDE | | |
|---|--|--|
|  | | |
| x | | |
| VARDE İKİLİ 1202 | | |
| f h | | |
| Ö f b | | |

| VARDE | | |
|--------------------------|--|--|
| Ø | | |
| x | | |
| VARDE ÜÇLÜ 1203 | | |
| f h | | |
| Ö f b | | |

| SALY | | |
|---|--|--|
|  | | |
| x | | |
| SALY ÇİFTLİ 1212 | | |
| f h | | |
| Ö f b | | |

| SALY | | |
|-------------------------|--|--|
| Ø | | |
| x | | |
| SALY ÜÇLÜ 1213 | | |
| f h | | |
| Ö f b | | |

| HERSILIA | | |
|---|--|--|
|  | | |
| x | | |
| PO 271 6271 | | |
| A | | |
| Ö f b | | |

Oturma Grupları / Seating Groups

Sedirler/ Sofas

Fiyat Listesi / Price List
USD

| AKORDEON | | |
|---|-----|---|
|  | | |
| * | | |
| AKORDEON SEDİR 6200 | | |
| J | | |
| ø | | |
| 4 ø# | | |
| | Ö f | b |

| SUN | | |
|---|-----|---|
|  | | |
| * | | |
| SUN COACG SEDİR 141001 | | |
| øJ | | |
| | | |
| | Ö f | b |

| BAT | | |
|---|-----|---|
|  | | |
| * | | |
| BİGBAT 602 | | |
| J | | |
| ø | | |
| 4 ø | | |
| | Ö f | b |

| BALLOON | | |
|---|-----|---|
|  | | |
| * | | |
| NO17 İKİLİ 754 | | |
| KJ | | |
| Kø | | |
| K4 ø | | |
| | Ö f | b |

| TIANA | | |
|---|-----|---|
|  | | |
| * | | |
| NO1 BENCH 705 | | |
| J | | |
| ø | | |
| 4 ø | | |
| | Ö f | b |

| TUENA | | |
|---|-----|---|
|  | | |
| * | | |
| WO 15 İKİLİ 751_1 | | |
| J | | |
| ø | | |
| 4 ø | | |
| | Ö f | b |

| BANF | | |
|---|-----|---|
|  | | |
| x | | |
| CS 413 6413 | | |
| J | | |
| | | |
| | Ö f | b |

| TWING | | |
|---|-----|---|
|  | | |
| * | | |
| CS 116010 TWIG DOUBLE | | |
| | | |
| | Ö f | b |

| ROOK | | |
|---|-----|---|
|  | | |
| * | | |
| WO 12 İKİLİ 962 | | |
| JİA | | |
| JøA | | |
| | Ö f | b |

Oturma Grupları / Seating Groups

Sedirler/ Sofas

Fiyat Listesi / Price List
USD

| ETHNIC | | |
|---|--|--|
|  | | |
| * | | |
| ETNİK 03 153 | | |
| øJ | | |
| øJu | | |
| Ö f b | | |

| ETHNIC | | |
|---|--|--|
|  | | |
| * | | |
| ETNİK 06 156 | | |
| øJ | | |
| øJu | | |
| Ö f b | | |

| OCTAGON | | |
|---|--|--|
|  | | |
| * | | |
| SEKİZGEN 2Lİ KOLTUK 649 | | |
| J | | |
| Ö f b | | |

| SEYSELLER | | |
|---|--|--|
|  | | |
| * | | |
| ÖRME BANK 116018 | | |
| øJ | | |
| øJu | | |
| Ö f b | | |

| ESPRESSO | | |
|---|--|--|
|  | | |
| * | | |
| MESH 49 BAR 949 | | |
| øJu | | |
| øJ | | |
| Ö f b | | |

Oturma Grupları / Seating Groups

Sedirler/ Sofas

Fiyat Listesi / Price List
USD

OTTOMAN



*

NO13 TEKLİ | 746

| | | |
|-------|--|--|
| J | | |
| # | | |
| # | | |
| Ö f b | | |

OTTOMAN



*

NO13 ÇİFTLİ | 747

| | | |
|-------|--|--|
| J | | |
| # | | |
| # | | |
| Ö f b | | |

OTTOMAN



*

NO13 ÜÇLÜ | 748

| | | |
|-------|--|--|
| J | | |
| # | | |
| # | | |
| Ö f b | | |

SWING



*

SWING 01 | 790

| | | |
|-------|--|--|
| J | | |
| # | | |
| # | | |
| Ö f b | | |

SWING



*

SWING 02 | 791

| | | |
|-------|--|--|
| J | | |
| # | | |
| # | | |
| Ö f b | | |

Dış Mekan Setler / Outdoor Sets

Fiyat Listesi / Price List
USD

| DELOS | | |
|---|--|--|
|  | | |
| * | | |
| AKT 01 BERJER 1001 | | |
| JA | | |
| Ö f b | | |

| DELOS | | |
|---|--|--|
|  | | |
| * | | |
| AKT 01 ÇİFTLİ 1002 | | |
| JA | | |
| Ö f b | | |

| DELOS | | |
|---|--|--|
|  | | |
| * | | |
| AKT 01 ÜÇLÜ 1003 | | |
| JA | | |
| Ö f b | | |

| DELOS | | |
|---|--|--|
|  | | |
| * | | |
| AKT 01 SEHPA 1004 | | |
| JA | | |
| Ö f b | | |

Dış Mekan Setler / Outdoor Sets

Fiyat Listesi / Price List
USD

| OUDDORP | | |
|---|--|--|
|  | | |
| * | | |
| AKT 02 BERJER 1021 | | |
| JA | | |
| Ö f b | | |

| OUDDORP | | |
|---|--|--|
|  | | |
| * | | |
| AKT 02 ÇİFTLİ 1022 | | |
| JA | | |
| Ö f b | | |

| OUDDORP | | |
|---|--|--|
|  | | |
| * | | |
| AKT 02 SEHPA 1023 | | |
| JA | | |
| Ö f b | | |

Dış Mekan Setler / Outdoor Sets

Fiyat Listesi / Price List
USD

| PARALIA | | |
|---|--|--|
|  | | |
| * | | |
| AKT3 BERJER 1041 | | |
| JA | | |
| Ö f b | | |

| PARALIA | | |
|---|--|--|
|  | | |
| * | | |
| AKT3 ÇİFTLİ 1042 | | |
| JA | | |
| Ö f b | | |

| PARALIA | | |
|---|--|--|
|  | | |
| * | | |
| AKT3 SEHPA 1043 | | |
| JA | | |
| Ö f b | | |

Dış Mekan Setler / Outdoor Sets

Fiyat Listesi / Price List
USD

| CARVIN | | |
|---|--|--|
|  | | |
| * | | |
| W013 963 | | |
| JA | | |
| Ö f b | | |

| CARVIN | | |
|---|--|--|
|  | | |
| * | | |
| AKT4 BERJER 1061 | | |
| JA | | |
| Ö f b | | |

| CARVIN | | |
|---|--|--|
|  | | |
| * | | |
| AKT4 ÇİFTLİ 1062 | | |
| JA | | |
| Ö f b | | |

| CARVIN | | |
|---|--|--|
|  | | |
| * | | |
| AKT4 ÜÇLÜ 1063 | | |
| JA | | |
| Ö f b | | |

Dış Mekan Setler / Outdoor Sets

Fiyat Listesi / Price List
USD

| NORD | | |
|---|--|--|
|  | | |
| * | | |
| AKT 05 BERJER 1081 | | |
| JA | | |
| Ö f b | | |

| NORD | | |
|---|--|--|
|  | | |
| * | | |
| AKT 05 ÇİFTLİ 1082 | | |
| JA | | |
| Ö f b | | |

| NORD | | |
|---|--|--|
|  | | |
| * | | |
| AKT 05 ÜÇLÜ 1083 | | |
| JA | | |
| Ö f b | | |

| NORD | | |
|---|--|--|
|  | | |
| * | | |
| AKT 05 SEHPA 1084 | | |
| JA | | |
| Ö f b | | |

Dış Mekan Setler / Outdoor Sets

Fiyat Listesi / Price List
USD

| | | |
|---|--|--|
| CLARA | | |
|  | | |
| * | | |
| W017 967 | | |
| JA | | |
| Ö f b | | |

| | | |
|---|--|--|
| CLARA | | |
|  | | |
| * | | |
| W018 968 | | |
| JA | | |
| Ö f b | | |

| | | |
|---|--|--|
| CLARA | | |
|  | | |
| * | | |
| AKT 06 BERJER 1100 | | |
| JA | | |
| Ö f b | | |

| | | |
|---|--|--|
| CLARA | | |
|  | | |
| * | | |
| AKT 06 ÇİFTLİ 1101 | | |
| JA | | |
| Ö f b | | |

| | | |
|---|--|--|
| CLARA | | |
|  | | |
| * | | |
| AKT 06 ÜÇLÜ 1102 | | |
| JA | | |
| Ö f b | | |

| | | |
|---|--|--|
| CLARA | | |
|  | | |
| * | | |
| AKT 06 DAYBED 1104 | | |
| JA | | |
| Ö f b | | |

| | | |
|---|--|--|
| CLARA | | |
|  | | |
| * | | |
| AKT 06 SEHPA 1103 | | |
| JA | | |
| Ö f b | | |

Dış Mekan Setler / Outdoor Sets

Fiyat Listesi / Price List
USD

| BOON | | |
|---|--|--|
|  | | |
| * | | |
| AKT 08 SANDALYE 6136 | | |
| JA | | |
| Ö f b | | |

| BOON | | |
|---|--|--|
|  | | |
| * | | |
| AKT 08 BERJER 6135 | | |
| JA | | |
| Ö f b | | |

| BOON | | |
|---|--|--|
|  | | |
| * | | |
| AKT 08 ÇİFTLİ 6133 | | |
| JA | | |
| Ö f b | | |

| BOON | | |
|---|--|--|
|  | | |
| * | | |
| AKT 08 ÜÇLÜ 6134 | | |
| JA | | |
| Ö f b | | |

Dış Mekan Setler / Outdoor Sets

Fiyat Listesi / Price List
USD

| JUİST | | |
|---|--|--|
|  | | |
| * | | |
| AKT 07 SANDALYE 5202 | | |
| # | | |
| Ö f b | | |

| JUİST | | |
|---|--|--|
|  | | |
| * | | |
| AKT 07 MASA 1122 | | |
| l# | | |
| Ö f b | | |

Dış Mekan Setler / Outdoor Sets

Fiyat Listesi / Price List
USD

| ŞARM | |
|---|--|
|  | |
| * | |
| AKT 09 KOLTUK 6107 | |
| J4 ø# | |
| | |
| Ö f b | |

| ŞARM | |
|---|--|
|  | |
| * | |
| AKT 09 SEHPA 6107 | |
| 4 ø# | |
| | |
| Ö f b | |

Dış Mekan Setler / Outdoor Sets

Fiyat Listesi / Price List
USD

| BUTTERFLY | | |
|---|--|--|
|  | | |
| * | | |
| AKT 10 BERJER 6140 | | |
| JA | | |
| Ö f b | | |

| BUTTERFLY | | |
|---|--|--|
|  | | |
| * | | |
| AKT 10 ÇİFTLİ 6141 | | |
| JA | | |
| Ö f b | | |

| BUTTERFLY | | |
|---|--|--|
|  | | |
| * | | |
| AKT 10 SEHPA 6142 | | |
| JA | | |
| Ö f b | | |

Dış Mekan Setler / Outdoor Sets

Fiyat Listesi / Price List
USD

| PTN | | |
|---|--|--|
|  | | |
| * | | |
| PTN KOLTUK 6113 | | |
| J | | |
| øJ | | |
| Ö f b | | |

| PTN | | |
|---|--|--|
|  | | |
| * | | |
| PTN ÇİFTLİ 6114 | | |
| J | | |
| øJ | | |
| Ö f b | | |

| PTN | | |
|------------------------|--|--|
| Ø | | |
| * | | |
| PTN ÜÇLÜ 6115 | | |
| J | | |
| øJ | | |
| Ö f b | | |

| PTN | | |
|---|--|--|
|  | | |
| * | | |
| PTN SIRTLI KOLTUK 6113S | | |
| J | | |
| øJ | | |
| Ö f b | | |

| PTN | | |
|---|--|--|
|  | | |
| * | | |
| PTN SIRTLI ÇİFTLİ 6114S | | |
| J | | |
| øJ | | |
| Ö f b | | |

Dış Mekan Setler / Outdoor Sets

Fiyat Listesi / Price List
USD

| DINN | |
|---|--|
|  | |
| * | |
| DINN KOLSUZ ÖRME SANDALYE 124011 | |
| øJ | |
| øJu | |
| Ö f b | |

| DINN | |
|---|--|
|  | |
| * | |
| DINN KOLLU ÖRME SANDALYE 124002 | |
| øJ | |
| øJu | |
| Ö f b | |

| SEYSELLER | |
|---|--|
|  | |
| * | |
| SEYSELLER ÖRME SWİNG 116012 | |
| øJu | |
| Ö f b | |

| SEYSELLER | |
|---|--|
|  | |
| * | |
| SEYSELLER ÖRME ŞEZLONG 116013 | |
| øJu | |
| Ö f b | |

| SEYSELLER | |
|---|--|
|  | |
| * | |
| SEYSELLER AYAK UZATMALIK 116014 | |
| øJu | |
| Ö f b | |

| SEYSELLER | |
|---|--|
|  | |
| * | |
| SEYSELLER ÖRME UZUN ŞEZLONG 116015 | |
| øJu | |
| Ö f b | |

| SEYSELLER | |
|---|--|
|  | |
| * | |
| SEYSELLER ÖRME HAMAK 116016 | |
| øJu | |
| Ö f b | |

| SEYSELLER | |
|---|--|
|  | |
| * | |
| TERAS ÜSTÜ SEHPA 124009 | |
| øJ | |
| / f b | |

Dış Mekan Setler / Outdoor Sets

Fiyat Listesi / Price List
USD

| VARDE | | |
|---|--|--|
|  | | |
| x | | |
| VARDE TEKLI 1201 | | |
| f h | | |
| <div style="display: flex; justify-content: space-around;"> Ö f b </div> | | |

| VARDE | | |
|---|--|--|
|  | | |
| x | | |
| VARDE İKİLİ 1202 | | |
| f h | | |
| <div style="display: flex; justify-content: space-around;"> Ö f b </div> | | |

| VARDE | | |
|---|--|--|
|  | | |
| x | | |
| VARDE ÜÇLÜ 1203 | | |
| f h | | |
| <div style="display: flex; justify-content: space-around;"> Ö f b </div> | | |

| VARDE | | |
|---|--|--|
|  | | |
| x | | |
| VARDE SEHPA 1204 | | |
| f h | | |
| <div style="display: flex; justify-content: space-around;"> Ö f b </div> | | |

Dış Mekan Setler / Outdoor Sets

Fiyat Listesi / Price List
USD

| SALY | | |
|---|---|---|
|  | | |
| x | | |
| SALY TEKLI 1211 | | |
| f h | | |
| | | |
| Ö | f | b |

| SALY | | |
|---|---|---|
|  | | |
| x | | |
| SALY ÇİFTLİ 1212 | | |
| f h | | |
| | | |
| Ö | f | b |

| SALY | | |
|---|---|---|
|  | | |
| x | | |
| SALY ÜÇLÜ 1213 | | |
| f h | | |
| | | |
| Ö | f | b |

| SALY | | |
|--|---|---|
|  | | |
| x | | |
| SALY SEHPA 1214 | | |
| f h | | |
| | | |
| Ö | f | b |

Dış Mekan Bahçe Ürünleri

Outdoor Garden Products

Fiyat Listesi / Price List
USD

| OCTAGON | | |
|---|--|--|
|  | | |
| * | | |
| SEKİZGEN ŞEZLONG 646 | | |
| øJ | | |
| Ö f b | | |

| CLARA | | |
|---|--|--|
|  | | |
| * | | |
| AKT 06 DAYBED 1104 | | |
| JA | | |
| Ö f b | | |

| SEYSELLER | | |
|---|--|--|
|  | | |
| * | | |
| SEYSELLER ÖRME UZUN ŞEZLONG 116015 | | |
| øJu | | |
| Ö f b | | |

| SEYSELLER | | |
|---|--|--|
|  | | |
| * | | |
| SEYSELLER ÖRME SWİNG 116012 | | |
| øJu | | |
| Ö f b | | |

| SEYSELLER | | |
|---|--|--|
|  | | |
| * | | |
| SEYSELLER ÖRME ŞEZLONG 116013 | | |
| øJu | | |
| Ö f b | | |

| SEYSELLER | | |
|---|--|--|
|  | | |
| * | | |
| SEYSELLER AYAK UZATMALIK 116014 | | |
| øJu | | |
| Ö f b | | |

| SEYSELLER | | |
|---|--|--|
|  | | |
| * | | |
| PANLON ÖRME HAMAK 116016 | | |
| øJu | | |
| Ö f b | | |

| OCTAGON | | |
|---|--|--|
|  | | |
| * | | |
| SEKİZGEN KOLLU BERJER 93 | | |
| øJ | | |
| Ö f b | | |

| OCTAGON | | |
|---|--|--|
|  | | |
| * | | |
| SEKİZGEN ŞEZLONG TABURESİ 89 | | |
| øJ | | |
| Ö f b | | |

Ofis Ürünleri / Office Products

Fiyat Listesi / Price List
USD

| ZIRA | | |
|---|-----|---|
|  | | |
| * | | |
| AMORTİSÖRLÜ KISA ZIRA SANDALYE 144 | | |
| J | | |
| ø | | |
| 4 ø | | |
| | Ö f | b |

| ZIRA | | |
|---|-----|---|
|  | | |
| * | | |
| AMORTİSÖRLÜ UZUN ZIRA SANDALYE 164 | | |
| J | | |
| ø | | |
| 4 ø | | |
| | Ö f | b |

| CRESCENT | | |
|---|-----|---|
|  | | |
| * | | |
| AMORTİSÖRLÜ HİLAL SANDALYE 183 | | |
| J | | |
| ø | | |
| 4 ø | | |
| | Ö f | b |

| GANEM | | |
|---|-----|---|
|  | | |
| * | | |
| AMORTİSÖRLÜ GANEM SANDALYE 543 | | |
| J | | |
| ø | | |
| 4 ø | | |
| | Ö f | b |

| BALLOON | | |
|---|-----|---|
|  | | |
| * | | |
| NO17 AMORTİSÖRLÜ 754 | | |
| AJ | | |
| Aø | | |
| A4 ø | | |
| | Ö f | b |

| BOSS | | |
|---|-----|---|
|  | | |
| * | | |
| NO22 765 | | |
| 4 ø | | |
| | Ö f | b |

| MAKAM | | |
|---|-----|---|
|  | | |
| * | | |
| UZUN MAKAM METAL AYAK 261 | | |
| J | | |
| ø | | |
| 4 ø | | |
| | Ö f | b |

| MAKAM | | |
|---|-----|---|
|  | | |
| * | | |
| UZUN MAKAM AMORTİSÖRLÜ 262 | | |
| J | | |
| ø | | |
| 4 ø | | |
| | Ö f | b |

| MAKAM | | |
|---|-----|---|
|  | | |
| * | | |
| KISA MAKAM METAL AYAK 263 | | |
| J | | |
| ø | | |
| 4 ø | | |
| | Ö f | b |

Ofis Ürünleri / Office Products

Fiyat Listesi / Price List
USD

| FORM | | |
|---|---|--|
|  | | |
| * | | |
| FORM 01 691 | | |
| øb | Ø | |
| ø | Ø | |
| Ö f b | | |

| FORM | | |
|---|---|--|
|  | | |
| * | | |
| FORM 02 692 | | |
| øb | Ø | |
| ø | Ø | |
| øø | Ø | |
| Ö f b | | |

| FORM | | |
|---|---|--|
|  | | |
| * | | |
| FORM 03 693 | | |
| øb | Ø | |
| ø | Ø | |
| Ö f b | | |

| MAKAM | | |
|---|--|--|
|  | | |
| * | | |
| KISA MAKAM AMORTİSÖRLÜ 264 | | |
| J | | |
| ø_ | | |
| 4 ø | | |
| Ö f b | | |

| CYLINDER | | |
|---|--|--|
|  | | |
| * | | |
| ŞEZLONG FW 129001 | | |
| J | | |
| ø_ | | |
| 4 ø# | | |
| Ö f b | | |

| - | | |
|---|--|--|
|  | | |
| x | | |
| A 006 6306 | | |
| | | |
| Ö f b | | |

| METAL | | |
|---|--|--|
|  | | |
| * | | |
| METAL KİTAPLIK - 1 205 | | |
| J | | |
| ø_ | | |
| 4 ø | | |
| Ö f b | | |

| METAL | | |
|---|--|--|
|  | | |
| * | | |
| METAL KİTAPLIK - 2 204 | | |
| J | | |
| ø_ | | |
| 4 ø | | |
| Ö f b | | |

| METAL | | |
|---|--|--|
|  | | |
| * | | |
| METAL KİTAPLIK - 3 207 | | |
| J | | |
| ø_ | | |
| 4 ø | | |
| Ö f b | | |

Masa Ayakları / Table Base

Fiyat Listesi / Price List
USD



X

| | | |
|----------|--|--|
| 38x38 cm | | |
| u | | |
| u | | |
| u | | |
| u | | |
| u | | |
| u | | |



X

| | | |
|----------|--|--|
| 42x42 cm | | |
| u | | |



X

| | | |
|----------|--|--|
| 38x38 cm | | |
| u | | |



X

| | | |
|----------|--|--|
| 38x38 cm | | |
| u | | |
| u | | |
| u | | |



X

| | | |
|----------|--|--|
| 38x38 cm | | |
| u | | |



X

| | | |
|----------|--|--|
| 38x38 cm | | |
| u | | |



X

| | | |
|----------|--|--|
| 38x38 cm | | |
| u | | |
| u | | |
| u | | |
| u | | |



X

| | | |
|----------|--|--|
| 38x20 cm | | |
| u | | |



X

| | | |
|----------|--|--|
| 38x38 cm | | |
| u | | |

Masa Ayakları / Table Base

Fiyat Listesi / Price List
USD

| | | |
|---|----------|--|
|  | | |
| x | 38x38 cm | |
| u | | |
| u | | |

| | | |
|---|-------|--|
|  | | |
| x | Scala | |
| u | | |

| | | |
|---|--------|--|
|  | | |
| x | Q38 cm | |
| u | | |

| | | |
|---|--------|--|
|  | | |
| x | Q42 cm | |
| u | | |

| | | |
|---|--------|--|
|  | | |
| x | Q38 cm | |
| u | | |

| | | |
|---|--------|--|
|  | | |
| x | Q42 cm | |
| u | | |

| | | |
|---|---|--|
|  | | |
| x | O | |
| u | | |

| | | |
|---|---|--|
|  | | |
| x | O | |
| u | | |

Masa Ayakları / Table Base

Fiyat Listesi / Price List
USD

| | | |
|---|----------|--|
|  | | |
| x | 40x40 cm | |
| u | | |

| | | |
|---|----------|--|
|  | | |
| x | 38x38 cm | |
| u | | |

| | | |
|---|----------|--|
|  | | |
| x | 40x40 cm | |
| u | | |

| | | |
|---|----------|--|
|  | | |
| x | 48X48 cm | |
| u | | |

| | | |
|---|--------|--|
|  | | |
| x | Q55 cm | |
| u | | |

| | | |
|---|--------|--|
|  | | |
| x | Q45 cm | |
| u | | |

| | | |
|---|--------|--|
|  | | |
| x | Q38 cm | |
| u | | |
| u | | |
| u | | |
| u | | |

| | | |
|---|--------|--|
|  | | |
| x | Q50 cm | |
| u | | |
| u | | |
| u | | |

| | | |
|---|--------|--|
|  | | |
| x | Q38 cm | |
| u | | |
| u | | |
| u | | |

Masa Ayakları / Table Base

Fiyat Listesi / Price List
USD



Masa Ayakları / Table Base

Fiyat Listesi / Price List
USD



Masa Ayakları / Table Base

Fiyat Listesi / Price List
USD

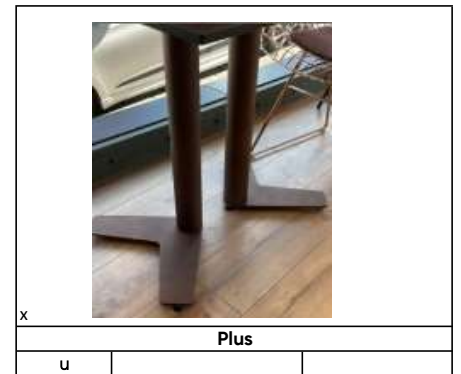
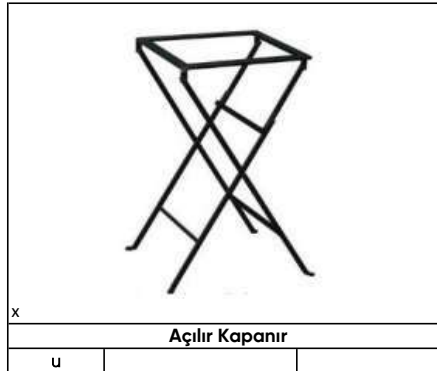
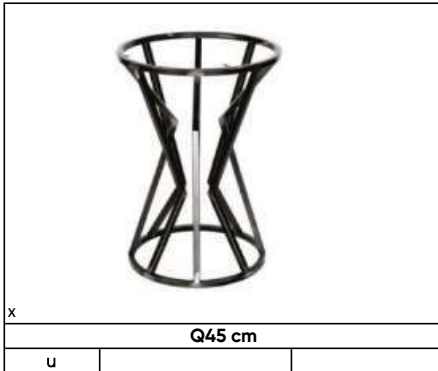
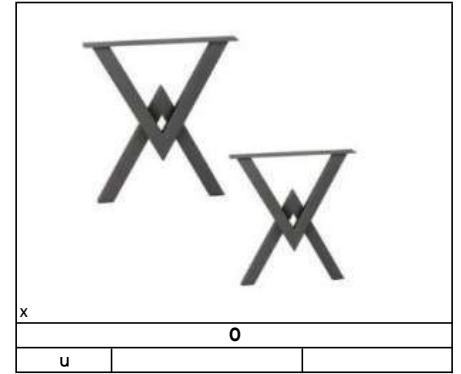
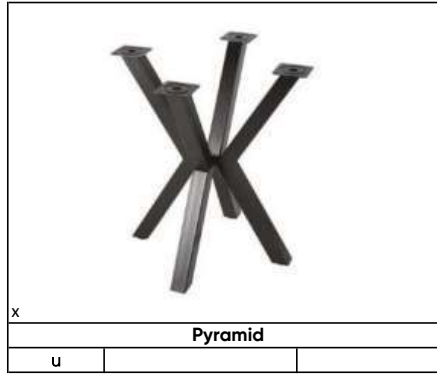

Masa Ayakları / Table Base

Fiyat Listesi / Price List
USD

| | | |
|---|--|--|
|  | | |
| x | | |
| | | |

| | | |
|---|--|--|
|  | | |
| x | | |
| | | |

| | | |
|---|------|-----|
|  | | |
| #YOK | | |
| | #YOK | |
| | 1 ø | 1 ø |

Masa Ayakları / Table Base

Fiyat Listesi / Price List
USD



Masa Ayakları / Table Base

Fiyat Listesi / Price List
USD



Masa Ayakları / Table Base

Fiyat Listesi / Price List
USD



Masa Ayakları / Table Base

Bistro

Fiyat Listesi / Price List
USD

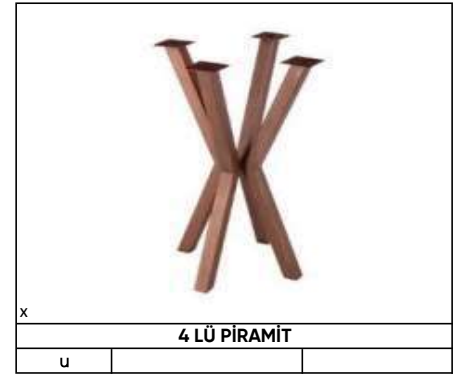

Masa Ayakları / Table Base

Fiyat Listesi / Price List
USD

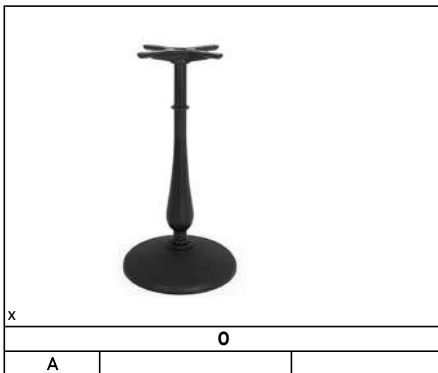
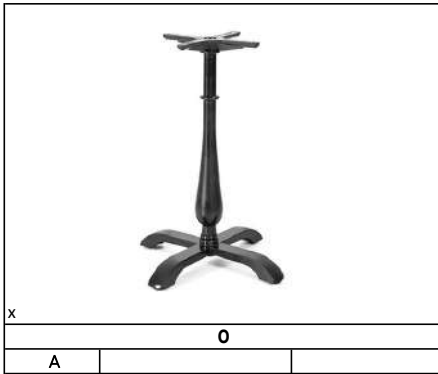
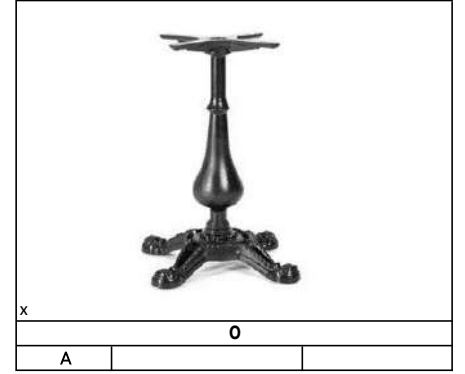
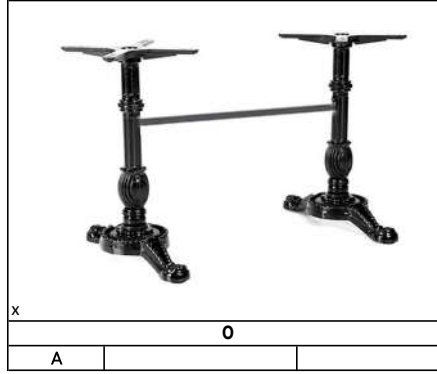
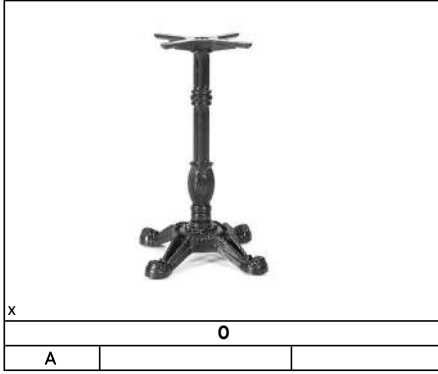

Masa Ayakları / Table Base

Fiyat Listesi / Price List
USD

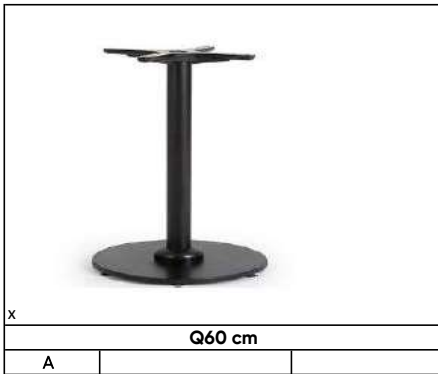
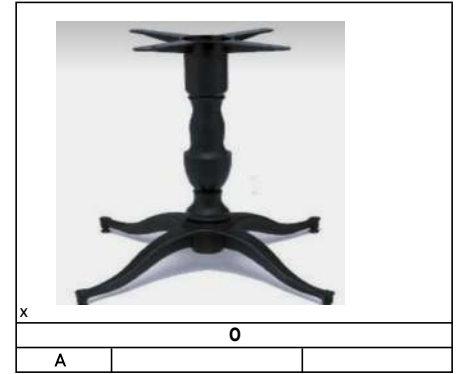
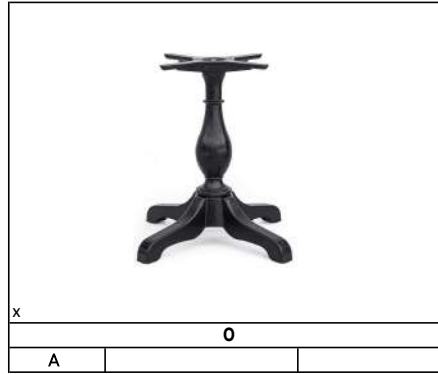
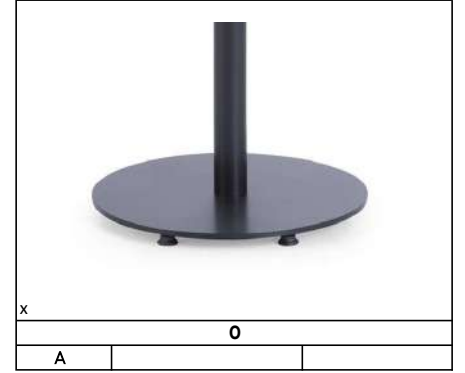
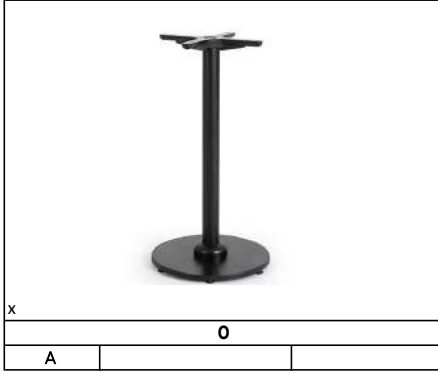

Masa Ayakları / Table Base

Fiyat Listesi / Price List
USD



Masa Ayakları / Table Base

Fiyat Listesi / Price List
USD

| STAR | | |
|---|--|--|
|  | | |
| * | | |
| YILDIZ MASA 107 | | |
| J | | |
| ø | | |
| 4 ø | | |
| Ö f b | | |

| PYRAMID | | |
|---|--|--|
|  | | |
| * | | |
| PİRAMİT MASA 503 | | |
| J | | |
| ø | | |
| 4 ø | | |
| Ö f b | | |

| BASKET | | |
|---|--|--|
|  | | |
| * | | |
| POTA BIG MASA 566 | | |
| J | | |
| ø | | |
| 4 ø | | |
| Ö f b | | |

| BASKET | | |
|---|--|--|
|  | | |
| * | | |
| POTA MASA 567 | | |
| J | | |
| ø | | |
| 4 ø | | |
| Ö f b | | |

| CUP | | |
|---|--|--|
|  | | |
| * | | |
| KUPA MASA 587 | | |
| J | | |
| ø | | |
| 4 ø | | |
| Ö f b | | |

| SPIDER | | |
|---|--|--|
|  | | |
| * | | |
| M10 MASA 274 | | |
| J | | |
| ø | | |
| 4 ø | | |
| Ö f b | | |

| LEAF | | |
|---|--|--|
|  | | |
| * | | |
| M6 MASA 304 | | |
| J | | |
| ø | | |
| 4 ø | | |
| Ö f b | | |

| CAGE | | |
|---|--|--|
|  | | |
| * | | |
| KAFES MASA 624 | | |
| J | | |
| ø | | |
| 4 ø | | |
| Ö f b | | |

| M8 | | |
|---|--|--|
|  | | |
| * | | |
| M8 MASA 857 | | |
| J | | |
| ø | | |
| 4 ø | | |
| Ö f b | | |

Masa Ayakları / Table Base

Fiyat Listesi / Price List
USD

| 3 LEGS | | |
|---|-----|---|
|  | | |
| * | | |
| M6 MASA 855 | | |
| J | | |
| ø | | |
| 4 ø# | | |
| | Ö f | b |

| VASE | | |
|---|-----|---|
|  | | |
| * | | |
| VAZO MASA 6019 | | |
| J | | |
| ø | | |
| 4 ø | | |
| | Ö f | b |

| GOBLET | | |
|---|-----|---|
|  | | |
| * | | |
| KADEH MASA 862 | | |
| J | | |
| | | |
| | Ö f | b |

| OCTAGON | | |
|---|-----|---|
|  | | |
| * | | |
| Q75 SEKİZGEN MASA 650 | | |
| J | | |
| ø | | |
| 4 ø | | |
| | Ö f | b |

| OCTAGON | | |
|---|-----|---|
|  | | |
| * | | |
| Q110 SEKİZGEN MASA 647 | | |
| J | | |
| ø | | |
| 4 ø | | |
| | Ö f | b |

| ESPRESSO | | |
|---|-----|---|
|  | | |
| * | | |
| KATLANIR MASA 861 | | |
| øJ | | |
| | | |
| | Ö f | b |

| HOOK | | |
|---|-----|---|
|  | | |
| * | | |
| SEM 4 KIVRIM MASA AYIĞI 6326 | | |
| J | | |
| | | |
| | Ö f | b |

| NORDIC | | |
|---|-----|---|
|  | | |
| * | | |
| BAMBU SEHPA 974 | | |
| øJ | | |
| | | |
| | Ö f | b |

| ESPRESSO | | |
|---|-----|---|
|  | | |
| * | | |
| TABAN AĞIRLIKLİ SAÇ MASA 7033 | | |
| J | | |
| | | |
| | Ö f | b |

Masa Ayakları / Table Base

Fiyat Listesi / Price List
USD

| MESH | | |
|---|--|--|
|  | | |
| * MESH MASA 6093 | | |
| J | | |
| Ö f b | | |

| CLAW | | |
|---|--|--|
|  | | |
| * PENCE MASA 6136 | | |
| J | | |
| Ö f b | | |

| CLAW | | |
|---|--|--|
|  | | |
| * BAĞLANTILI PENCE MASA 6137 | | |
| J | | |
| Ö f b | | |

| BLADE | | |
|---|--|--|
|  | | |
| * YAPRAK MASA 6070 | | |
| J | | |
| Ö f b | | |

| - | | |
|---|--|--|
|  | | |
| x HPL Masa Tablası ile Ahşap Ayak | | |
| | | |
| Ö f b | | |

| - | | |
|---|--|--|
|  | | |
| x HPL Masa Tablası ile Ahşap Ayak | | |
| | | |
| Ö f b | | |

Masa Ayakları / Table Base

Fiyat Listesi / Price List
USD

| BASKET | | |
|---|--|--|
|  | | |
| * POTA DÖRTLÜ MASA AYIĞI 568 | | |
| J | | |
| ø_ | | |
| 4 ø | | |
| Ö f b | | |

| BAT | | |
|---|--|--|
|  | | |
| * BAT MASA 603 | | |
| J | | |
| ø_ | | |
| 4 ø | | |
| Ö f b | | |

| JUİST | | |
|---|--|--|
|  | | |
| * AKT 07 MASA 1122 | | |
| I# | | |
| Ö f b | | |

| CRYSTAL | | |
|---|--|--|
|  | | |
| * KRİSTAL MASA 859 | | |
| J | | |
| ø_ | | |
| 4 ø# | | |
| Ö f b | | |

| NEW STAR | | |
|---|--|--|
|  | | |
| * YENİ YILDIZ MASA 860 | | |
| J | | |
| ø_ | | |
| 4 ø# | | |
| Ö f b | | |

| M3 | | |
|---|--|--|
|  | | |
| * M3 MASA 852 | | |
| J | | |
| ø_ | | |
| # | | |
| Ö f b | | |

| M1 | | |
|---|--|--|
|  | | |
| * M1 MASA 850 | | |
| J | | |
| ø_ | | |
| 4 ø | | |
| Ö f b | | |

| M2 | | |
|---|--|--|
|  | | |
| * M2 MASA 851 | | |
| J | | |
| ø_ | | |
| # | | |
| Ö f b | | |

| M4 | | |
|---|--|--|
|  | | |
| * M4 MASA 853 | | |
| J | | |
| ø_ | | |
| 4 ø# | | |
| Ö f b | | |

Masa Ayakları / Table Base

Fiyat Listesi / Price List
USD

| M5 | | |
|---|--|--|
|  | | |
| * | | |
| M5 MASA 854 | | |
| J | | |
| 4 ø# | | |
| Ö f b | | |

| ZIGZAG | | |
|---|--|--|
|  | | |
| * | | |
| ZIGZAG MASA 858 | | |
| J | | |
| # | | |
| Ö f b | | |

| M7 | | |
|---|--|--|
|  | | |
| * | | |
| M7 MASA 856 | | |
| J | | |
| 4 ø# | | |
| Ö f b | | |

| BASKET | | |
|---|--|--|
|  | | |
| * | | |
| POTA BAR MASASI 569 | | |
| J | | |
| ø_ | | |
| 4 ø | | |
| Ö f b | | |

| CUP | | |
|---|--|--|
|  | | |
| * | | |
| KUPA BAR MASASI 586 | | |
| J | | |
| ø_ | | |
| 4 ø | | |
| Ö f b | | |

Masa Tablaları / Tables

Ahşap Tablalar / Wooden Table Tops

Fiyat Listesi / Price List
USD



x

| 70X70 5CM MASA TABLASI | | |
|------------------------|----|----|
| u | Ac | ÖJ |
| u | Ac | u |



x

| 70X130 5CM MASA TABLASI | | |
|-------------------------|----|---|
| u | Ac | u |



x

| 80X80 5CM MASA TABLASI | | |
|------------------------|----|----|
| u | Ac | K |
| u | Ac | ø |
| u | Ac | u |
| u | Ac | ÖJ |



x

| Q130 5CM MASA TABLASI | | |
|-----------------------|----|---|
| u | Ac | K |



x

| 80x80 AHŞAP MASA TABLASI | | |
|--------------------------|----|----|
| u | AA | øø |



x

| 70x70 AHŞAP MASA TABLASI | | |
|--------------------------|----|-----|
| u | AA | u ø |

Masa Tablaları / Tables

Kaplama Tablalar / Winner Table Tops

Fiyat Listesi / Price List
USD



Masa Tablaları / Tables

Mermer Tablalar / Marble Table Tops

Fiyat Listesi / Price List
USD

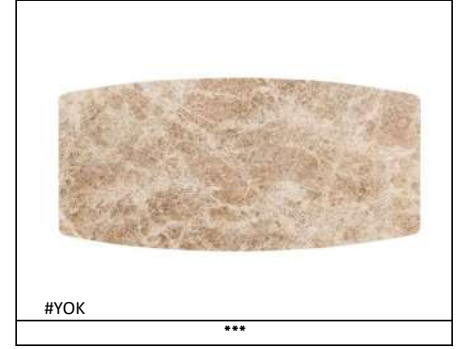

Masa Tablaları / Tables

Kompakt Tablalar / Compact Table Tops

Fiyat Listesi / Price List
USD

| Standart Ölçüler / Standard Sizes |
|-----------------------------------|
| 60x60 cm |
| 69x69 cm |
| 76x76 cm |
| 80x80 cm |
| 90x90 cm |
| 60x70 cm |
| 69x120 cm |
| 76x120 cm |
| 80x120 cm |
| 76x139 cm |
| 80x139 cm |
| 90x150 cm |
| 90x180 cm |

| BEYAZ |
|---|
|  |
| SOLID COLORS |

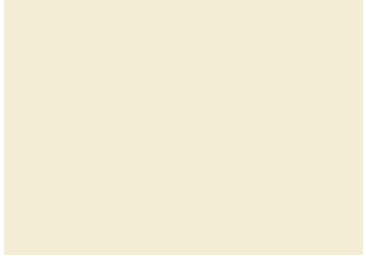
| KREM |
|---|
|  |
| SOLID COLORS |

| SİYAH |
|---|
|  |
| SOLID COLORS |

| GİRİ |
|---|
|  |
| SOLID COLORS |

| ANTRASİT GİRİ |
|---|
|  |
| SOLID COLORS |

| NOWAGENTO |
|---|
|  |
| WOOD COLORS |

| TRUVA |
|---|
|  |
| WOOD COLORS |

Masa Tablaları / Tables

Kompakt Tablalar / Compact Table Tops Fiyat Listesi / Price List USD

DENZİLİ MERMER



STONE COLORS

AFYON MERMER



STONE COLORS

SCALA



STONE COLORS

PASLI



STONE COLORS

METALİK OXSİD



STONE COLORS

MESSİNA

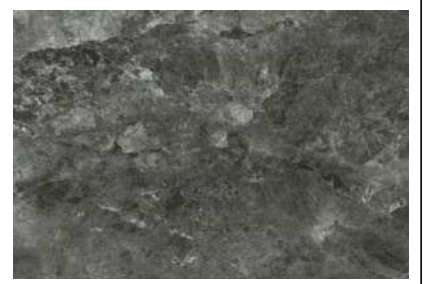

STONE COLORS

ROYAL MARBLE



STONE COLORS

PALAZZO



STONE COLORS

İVORY

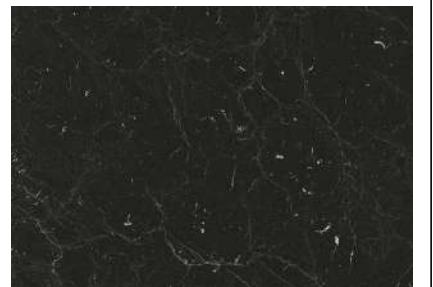

STONE COLORS

Masa Tablaları / Tables

Kompakt Tablalar / Compact Table Tops

| Product Feature | Product Code | Product Name | USD |
|-----------------|--------------|--------------|----------|
| 12 mm | MTAK126060 | 60x60 cm | - |
| | MTAK126969 | 69x69 cm | - |
| | MTAK127676 | 76x76 cm | - |
| | MTAK128080 | 80x80 cm | - |
| | MTAK129090 | 90x90 cm | - |
| | MTAK126070 | 60x70 cm | - |
| | MTAK1269120 | 69x120 cm | - |
| | MTAK1276120 | 76x120 cm | - |
| | MTAK1280120 | 80x120 cm | - |
| | MTAK1276139 | 76x139 cm | - |
| | MTAK1280139 | 80x139 cm | - |
| | MTAK1290150 | 90x150 cm | - |
| | MTAK1290180 | 90x180 cm | - |
| | 24 mm | MTAK246060 | 60x60 cm |
| MTAK246969 | | 69x69 cm | - |
| MTAK247676 | | 76x76 cm | - |
| MTAK248080 | | 80x80 cm | - |
| MTAK249090 | | 90x90 cm | - |
| MTAK246070 | | 60x70 cm | - |
| MTAK2469120 | | 69x120 cm | - |
| MTAK2476120 | | 76x120 cm | - |
| MTAK2480120 | | 80x120 cm | - |
| MTAK2476139 | | 76x139 cm | - |
| MTAK2480139 | | 80x139 cm | - |
| MTAK2490150 | | 90x150 cm | - |
| MTAK2490180 | | 90x180 cm | - |
| 36 mm | | MTAK366060 | 60x60 cm |
| | MTAK366969 | 69x69 cm | - |
| | MTAK367676 | 76x76 cm | - |
| | MTAK368080 | 80x80 cm | - |
| | MTAK369090 | 90x90 cm | - |
| | MTAK366070 | 60x70 cm | - |
| | MTAK3669120 | 69x120 cm | - |
| | MTAK3676120 | 76x120 cm | - |
| | MTAK3680120 | 80x120 cm | - |
| | MTAK3676139 | 76x139 cm | - |
| | MTAK3680139 | 80x139 cm | - |
| | MTAK3690150 | 90x150 cm | - |
| | MTAK3690180 | 90x180 cm | - |

| Product Feature | Product Code | Product Name | USD |
|-----------------------------------|-----------------------------------|--------------|----------|
| Gamma Cut | MTAKGK6060 | 60x60 cm | - |
| | MTAKGK6969 | 69x69 cm | - |
| | MTAKGK7676 | 76x76 cm | - |
| | MTAKGK8080 | 80x80 cm | - |
| | MTAKGK9090 | 90x90 cm | - |
| | MTAKGK6070 | 60x70 cm | - |
| | MTAKGK69120 | 69x120 cm | - |
| | MTAKGK76120 | 76x120 cm | - |
| | MTAKGK80120 | 80x120 cm | - |
| | MTAKGK76139 | 76x139 cm | - |
| | MTAKGK80139 | 80x139 cm | - |
| | MTAKGK90150 | 90x150 cm | - |
| | MTAKGK90180 | 90x180 cm | - |
| | Kutu Kesim 40 mm Box Cut 40 mm | MTAKKK406060 | 60x60 cm |
| MTAKKK406969 | | 69x69 cm | - |
| MTAKKK407676 | | 76x76 cm | - |
| MTAKKK408080 | | 80x80 cm | - |
| MTAKKK409090 | | 90x90 cm | - |
| MTAKKK406070 | | 60x70 cm | - |
| MTAKKK4069120 | | 69x120 cm | - |
| MTAKKK4076120 | | 76x120 cm | - |
| MTAKKK4080120 | | 80x120 cm | - |
| MTAKKK4076139 | | 76x139 cm | - |
| MTAKKK4080139 | | 80x139 cm | - |
| MTAKKK4090150 | | 90x150 cm | - |
| MTAKKK4090180 | | 90x180 cm | - |
| Kutu Kesim 60 mm Box Cut 60 mm | | MTAKKK606060 | 60x60 cm |
| | MTAKKK606969 | 69x69 cm | - |
| | MTAKKK607676 | 76x76 cm | - |
| | MTAKKK608080 | 80x80 cm | - |
| | MTAKKK609090 | 90x90 cm | - |
| | MTAKKK606070 | 60x70 cm | - |
| | MTAKKK6069120 | 69x120 cm | - |
| | MTAKKK6076120 | 76x120 cm | - |
| | MTAKKK6080120 | 80x120 cm | - |
| | MTAKKK6076139 | 76x139 cm | - |
| | MTAKKK6080139 | 80x139 cm | - |
| | MTAKKK6090150 | 90x150 cm | - |
| | MTAKKK6090180 | 90x180 cm | - |

Masa Tablaları / Tables

MDF&Kompakt / MDF&Compact

Fiyat Listesi / Price List
USD

Standart Ölçüler / Standard Sizes

| 25 mm | 18 mm | 12 mm |
|-----------|----------|----------|
| 60x60 cm | 50x50 cm | 50x50 cm |
| 70x70 cm | 60x60 cm | 60x60 cm |
| 80x80 cm | 70x60 cm | 70x60 cm |
| 70x120 cm | 70x70 cm | 70x70 cm |
| 80x120 cm | 80x80 cm | 80x80 cm |
| 70x140 cm | | |
| 80x140 cm | | |

SOLID COLORS



STONE COLORS

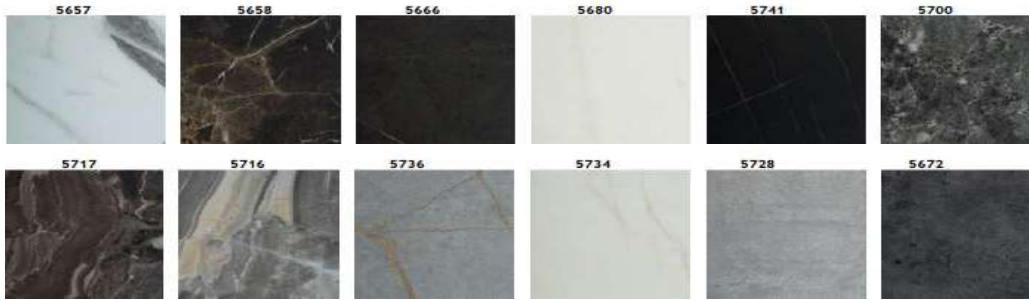

WOOD COLORS



Masa Tablaları / Tables

MDF&Kompakt / MDF&Compact

| Product Feature | Product Code | Product Name | USD |
|-----------------|--------------|--------------|-----|
| 25 mm | MTNMK256060 | 60x60 cm | - |
| | MTNMK257070 | 70x70 cm | - |
| | MTNMK258080 | 80x80 cm | - |
| | MTNMK2570120 | 70x120 cm | - |
| | MTNMK2580120 | 80x120 cm | - |
| | MTNMK2570140 | 70x140 cm | - |
| | MTNMK2580140 | 80x140 cm | - |
| 18 mm | MTNMK185050 | 50x50 cm | - |
| | MTNMK186060 | 60x60 cm | - |
| | MTNMK187060 | 70x60 cm | - |
| | MTNMK187070 | 70x70 cm | - |
| | MTNMK188080 | 80x80 cm | - |
| 12 mm | MTNMK125050 | 50x50 cm | - |
| | MTNMK126060 | 60x60 cm | - |
| | MTNMK127060 | 70x60 cm | - |
| | MTNMK127070 | 70x70 cm | - |
| | MTNMK128080 | 80x80 cm | - |

Masa Tablaları / Tables

Baskı Tablalar / Digital Table Tops

Fiyat Listesi / Price List
USD

Standart Ölçüler / Standard Sizes

| | |
|-----------|-------|
| 60x60 cm | Q 60 |
| 70x70 cm | Q 70 |
| 80x80 cm | Q 80 |
| 90x90 cm | Q 90 |
| 70x110 cm | Q 100 |
| 70x120 cm | Q 110 |
| 70x140 cm | Q 120 |
| 80x120 cm | Q 130 |
| 80x140 cm | Q 140 |



203.001

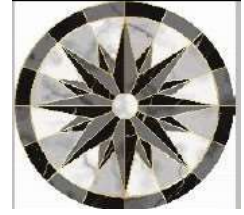

203.002



203.003



203.004



203.005

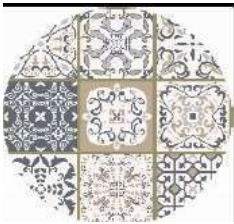

203.006



203.007



203.008

Masa Tablaları / Tables

Baskı Tablalar / Digital Table Tops

Fiyat Listesi / Price List
USD



203.009



203.010



203.011



203.012

R A L

203.013

(YEŞİL MERMER)

203.014



203.015



203.016



203.017

Masa Tablaları / Tables

Baskı Tablalar / Digital Table Tops

Fiyat Listesi / Price List
USD

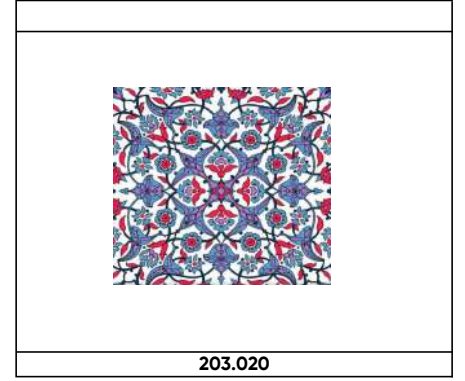
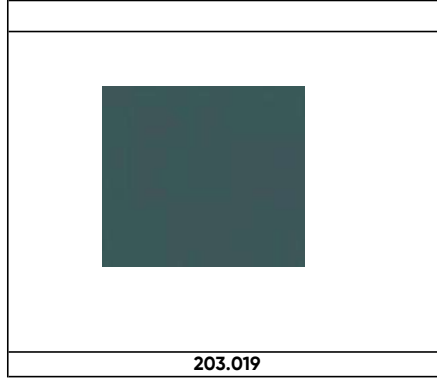

Masa Tablaları / Tables

Baskı Tablalar / Digital Table Tops

| Product Feature | Product Code | Product Name | USD |
|------------------|-------------------------|---------------------------|-----|
| Çerçevesi Mat | MTDPCM6060 | 60x60 Baskı Masa Tablası | - |
| | MTDPCM7070 | 70x70 Baskı Masa Tablası | - |
| | MTDPCM8080 | 80x80 Baskı Masa Tablası | - |
| | MTDPCM9090 | 90x90 Baskı Masa Tablası | - |
| | MTDPCM70110 | 70x110 Baskı Masa Tablası | - |
| | MTDPCM70120 | 70x120 Baskı Masa Tablası | - |
| | MTDPCM70140 | 70x140 Baskı Masa Tablası | - |
| | MTDPCM80120 | 80x120 Baskı Masa Tablası | - |
| | MTDPCM80140 | 80x140 Baskı Masa Tablası | - |
| | MTDPCMQ 60 | Q60 Baskı Masa Tablası | - |
| | MTDPCMQ 70 | Q70 Baskı Masa Tablası | - |
| | MTDPCMQ 80 | Q80 Baskı Masa Tablası | - |
| | MTDPCMQ 90 | Q90 Baskı Masa Tablası | - |
| | MTDPCMQ 100 | Q100 Baskı Masa Tablası | - |
| | MTDPCMQ 110 | Q110 Baskı Masa Tablası | - |
| | MTDPCMQ 120 | Q120 Baskı Masa Tablası | - |
| MTDPCMQ 130 | Q130 Baskı Masa Tablası | - | |
| MTDPCMQ 140 | Q140 Baskı Masa Tablası | - | |
| Çerçevesi Parlak | MTDPCP6060 | 60x60 Baskı Masa Tablası | - |
| | MTDPCP7070 | 70x70 Baskı Masa Tablası | - |
| | MTDPCP8080 | 80x80 Baskı Masa Tablası | - |
| | MTDPCP9090 | 90x90 Baskı Masa Tablası | - |
| | MTDPCP70110 | 70x110 Baskı Masa Tablası | - |
| | MTDPCP70120 | 70x120 Baskı Masa Tablası | - |
| | MTDPCP70140 | 70x140 Baskı Masa Tablası | - |
| | MTDPCP80120 | 80x120 Baskı Masa Tablası | - |
| | MTDPCP80140 | 80x140 Baskı Masa Tablası | - |
| | MTDPCPQ 60 | Q60 Baskı Masa Tablası | - |
| | MTDPCPQ 70 | Q70 Baskı Masa Tablası | - |
| | MTDPCPQ 80 | Q80 Baskı Masa Tablası | - |
| | MTDPCPQ 90 | Q90 Baskı Masa Tablası | - |
| | MTDPCPQ 100 | Q100 Baskı Masa Tablası | - |
| | MTDPCPQ 110 | Q110 Baskı Masa Tablası | - |
| | MTDPCPQ 120 | Q120 Baskı Masa Tablası | - |
| MTDPCPQ 130 | Q130 Baskı Masa Tablası | - | |
| MTDPCPQ 140 | Q140 Baskı Masa Tablası | - | |

| Product Feature | Product Code | Product Name | USD |
|-------------------|-------------------------|---------------------------|-----|
| Gama Kesim Mat | MTDPGKM6060 | 60x60 Baskı Masa Tablası | - |
| | MTDPGKM7070 | 70x70 Baskı Masa Tablası | - |
| | MTDPGKM8080 | 80x80 Baskı Masa Tablası | - |
| | MTDPGKM9090 | 90x90 Baskı Masa Tablası | - |
| | MTDPGKM70110 | 70x110 Baskı Masa Tablası | - |
| | MTDPGKM70120 | 70x120 Baskı Masa Tablası | - |
| | MTDPGKM70140 | 70x140 Baskı Masa Tablası | - |
| | MTDPGKM80120 | 80x120 Baskı Masa Tablası | - |
| | MTDPGKM80140 | 80x140 Baskı Masa Tablası | - |
| | MTDPGKMQ 60 | Q60 Baskı Masa Tablası | - |
| | MTDPGKMQ 70 | Q70 Baskı Masa Tablası | - |
| | MTDPGKMQ 80 | Q80 Baskı Masa Tablası | - |
| | MTDPGKMQ 90 | Q90 Baskı Masa Tablası | - |
| | MTDPGKMQ 100 | Q100 Baskı Masa Tablası | - |
| | MTDPGKMQ 110 | Q110 Baskı Masa Tablası | - |
| | MTDPGKMQ 120 | Q120 Baskı Masa Tablası | - |
| MTDPGKMQ 130 | Q130 Baskı Masa Tablası | - | |
| MTDPGKMQ 140 | Q140 Baskı Masa Tablası | - | |
| Gama Kesim Parlak | MTDPGKP6060 | 60x60 Baskı Masa Tablası | - |
| | MTDPGKP7070 | 70x70 Baskı Masa Tablası | - |
| | MTDPGKP8080 | 80x80 Baskı Masa Tablası | - |
| | MTDPGKP9090 | 90x90 Baskı Masa Tablası | - |
| | MTDPGKP70110 | 70x110 Baskı Masa Tablası | - |
| | MTDPGKP70120 | 70x120 Baskı Masa Tablası | - |
| | MTDPGKP70140 | 70x140 Baskı Masa Tablası | - |
| | MTDPGKP80120 | 80x120 Baskı Masa Tablası | - |
| | MTDPGKP80140 | 80x140 Baskı Masa Tablası | - |
| | MTDPGKQP 60 | Q60 Baskı Masa Tablası | - |
| | MTDPGKQP 70 | Q70 Baskı Masa Tablası | - |
| | MTDPGKQP 80 | Q80 Baskı Masa Tablası | - |
| | MTDPGKQP 90 | Q90 Baskı Masa Tablası | - |
| | MTDPGKQP 100 | Q100 Baskı Masa Tablası | - |
| | MTDPGKQP 110 | Q110 Baskı Masa Tablası | - |
| | MTDPGKQP 120 | Q120 Baskı Masa Tablası | - |
| MTDPGKQP 130 | Q130 Baskı Masa Tablası | - | |
| MTDPGKQP 140 | Q140 Baskı Masa Tablası | - | |

Sehpalar / Coffee Tables

Fiyat Listesi / Price List
USD

| STAR | | |
|---|-----|---|
|  | | |
| * | | |
| YILDIZ FİSKOS 108 | | |
| J | | |
| ø | | |
| 4 ø | | |
| | Ö f | b |

| BASKET | | |
|---|-----|---|
|  | | |
| * | | |
| POTA FİSKOS 562 | | |
| J | | |
| ø | | |
| 4 ø | | |
| | Ö f | b |

| BASKET | | |
|---|-----|---|
|  | | |
| * | | |
| POTA ORTA SEHPA 563 | | |
| J | | |
| ø | | |
| 4 ø | | |
| | Ö f | b |

| CUP | | |
|---|-----|---|
|  | | |
| * | | |
| KUPA FİSKOS 585 | | |
| J | | |
| ø | | |
| 4 ø | | |
| | Ö f | b |

| CAGE | | |
|---|-----|---|
|  | | |
| * | | |
| KAFES FİSKOS 623 | | |
| J | | |
| ø | | |
| 4 ø | | |
| | Ö f | b |

| OCTAGON | | |
|---|-----|---|
|  | | |
| * | | |
| SEKİZGEN FİSKOS 645 | | |
| J | | |
| ø | | |
| 4 ø | | |
| | Ö f | b |

| HT | | |
|---|-----|---|
|  | | |
| * | | |
| SEHPA / 6087 | | |
| ø | | |
| | / f | b |

| TRIPLE | | |
|---|-----|---|
|  | | |
| * | | |
| ÜÇLÜ SEHPA 832 | | |
| J | | |
| ø | | |
| 4 ø# | | |
| | Ö f | b |

| PELLUCID | | |
|---|-----|---|
|  | | |
| * | | |
| PLEKSİ SEHPA 001051 | | |
| 4 ø# | | |
| | Ö f | b |

Sehpalar / Coffee Tables

Fiyat Listesi / Price List
USD

| MINOTTI | | |
|---|-----|---|
|  | | |
| * | | |
| MINOTTI SEHPA BUYUK 834 | | |
| J | | |
| ø | | |
| 4 ø# | | |
| | Ö f | b |

| MINOTTI | | |
|---|-----|---|
|  | | |
| * | | |
| MINOTTI SEHPA ORTA 835 | | |
| J | | |
| ø | | |
| # | | |
| | / f | b |

| MINOTTI | | |
|---|-----|---|
|  | | |
| * | | |
| MINOTTI SEHPA KUÇUK 836 | | |
| J | | |
| ø | | |
| 4 ø# | | |
| | / f | b |

| M2 | | |
|---|-----|---|
|  | | |
| * | | |
| M2 ORTA SEHPA 833 | | |
| J | | |
| # | | |
| # | | |
| | Ö f | b |

| ZIGZAG | | |
|---|-----|---|
|  | | |
| * | | |
| ZIGZAG FISCOS 837 | | |
| J | | |
| # | | |
| | Ö f | b |

| ZIGZAG | | |
|---|-----|---|
|  | | |
| * | | |
| ZIGZAG ORTA SEHPA 838 | | |
| J | | |
| # | | |
| | Ö f | b |

| V GLASS | | |
|---|-----|---|
|  | | |
| * | | |
| 'V' AYAKLI SEHPA (Q100) 6033 | | |
| J4 ø | | |
| | Ö f | b |

| V GLASS | | |
|---|-----|---|
|  | | |
| * | | |
| 'V' AYAKLI SEHPA (Q60) 6033 | | |
| ø4 ø | | |
| | / f | b |

| MIRROR | | |
|---|-----|---|
|  | | |
| * | | |
| AYNALI SEHPA 839 | | |
| J | | |
| ø | | |
| 4 ø | | |
| | Ö f | b |

Sehpalar / Coffee Tables

Fiyat Listesi / Price List
USD

| LUMIN | | |
|---|--|--|
|  | | |
| * SEHPA 160006 | | |
| | | |
| / f b | | |

| LETTU | | |
|---|--|--|
|  | | |
| X PO 851 6851 SEHPA | | |
| q | | |
| Ö f b | | |

| BRUD | | |
|---|--|--|
|  | | |
| X PO 852 6852 SEHPA | | |
| q | | |
| Ö f b | | |

| FUNNEL | | |
|---|--|--|
|  | | |
| * ALİMİNYUM SEHPA 6111 | | |
| AJ | | |
| Ö f b | | |

| CONE | | |
|---|--|--|
|  | | |
| X HUNI SEHPA AYAĞI | | |
| | | |
| / f b | | |

| KNIGHT | | |
|---|--|--|
|  | | |
| * WO15 SEHPA / 6308 | | |
| øJ | | |
| / f b | | |

| BOX | | |
|---|--|--|
|  | | |
| * SEHPA 841 | | |
| A | | |
| Ö f b | | |

| KAWE | | |
|---|-------|--|
|  | | |
| * PO 156005 / SEHPA | | |
| | Ö f b | |
| Ö f b | | |

| CRYSTAL | | |
|---|--|--|
|  | | |
| * KRISTAL SEHPA 6000106 | | |
| J | | |
| ø | | |
| 4 ø | | |
| Ö f b | | |

Sehpalar / Coffee Tables

Fiyat Listesi / Price List
USD

| | | |
|---|--|--|
| HEXAGON | | |
|  | | |
| x | | |
| ALTİGEN ÜÇLÜ TAKIM | | |
| K | | |
| Ö f b | | |

| | | |
|---|--|--|
| CHURN | | |
|  | | |
| x | | |
| GÜĞÜM SEHPA | | |
| K | | |
| Ö f b | | |

| | | |
|---|--|--|
| SANDGLASS | | |
|  | | |
| x | | |
| KUM SAATİ SEHPA | | |
| K | | |
| Ö f b | | |

| | | |
|---|--|--|
| GEOMETRIC | | |
|  | | |
| x | | |
| GEOMETRİK SEHPA | | |
| K | | |
| Ö f b | | |

| | | |
|---|--|--|
| THIN | | |
|  | | |
| x | | |
| İNCE BOYUN SEHPA | | |
| K | | |
| Ö f b | | |

| | | |
|---|--|--|
| KNIT | | |
|  | | |
| x | | |
| ÇİFT BOĞUMLU SEHPA | | |
| K | | |
| Ö f b | | |

| | | |
|---|--|--|
| SPACE | | |
|  | | |
| x | | |
| UZAY SEHPA | | |
| K | | |
| Ö f b | | |

Sehpalar / Coffee Tables

Fiyat Listesi / Price List
USD

| | | | |
|---|---|---|---|
| - | | | |
|  | | | |
| x | | | |
| PO 1807 / 61807 SEHPA | | | |
| | Ö | f | b |
| | Ö | f | b |
| | | | |
| | | | |

| | | | |
|---|---|---|---|
| - | | | |
|  | | | |
| x | | | |
| PO 1809 / 61809 SEHPA | | | |
| | Ö | f | b |
| | | | |
| | | | |

| | | | |
|---|---|---|---|
| - | | | |
|  | | | |
| x | | | |
| PO 1810 / 61810 SEHPA | | | |
| | Ö | f | b |
| | Ö | f | b |
| | | | |
| | | | |

| | | | |
|---|---|---|---|
| - | | | |
|  | | | |
| x | | | |
| PO 1811 / 61811 SEHPA | | | |
| | Ö | f | b |
| | Ö | f | b |
| | | | |
| | | | |

| | | | |
|---|---|---|---|
| - | | | |
|  | | | |
| x | | | |
| PO 1801 / 61801 SEHPA | | | |
| | Ö | f | b |
| | Ö | f | b |
| | Ö | f | b |
| | | | |
| | | | |

| | | | |
|---|---|---|---|
| - | | | |
|  | | | |
| x | | | |
| PO 1802 / 61802 SEHPA | | | |
| | Ö | f | b |
| | Ö | f | b |
| | | | |
| | | | |

| | | | |
|---|---|---|---|
| - | | | |
|  | | | |
| x | | | |
| PO 1803 / 61803 SEHPA | | | |
| | Ö | f | b |
| | Ö | f | b |
| | | | |
| | | | |

| | | | |
|---|---|---|---|
| - | | | |
|  | | | |
| x | | | |
| PO 1804 / 61804 SEHPA | | | |
| | Ö | f | b |
| | Ö | f | b |
| | | | |
| | | | |

| | | | |
|---|--|--|--|
| CLOVER | | | |
|  | | | |
| * | | | |
| YONCA ORTA SEHPA 831 | | | |
| J | | | |
| 4 ø | | | |
| # | | | |
| / f b | | | |

Sehpalar / Coffee Tables

Fiyat Listesi / Price List
USD

| DELOS | | |
|---|--|--|
|  | | |
| * | | |
| AKT 01 SEHPA 1004 | | |
| JA | | |
| Ö f b | | |

| OUDDORP | | |
|---|--|--|
|  | | |
| * | | |
| AKT 02 SEHPA 1023 | | |
| JA | | |
| Ö f b | | |

| PARALIA | | |
|---|--|--|
|  | | |
| * | | |
| AKT3 SEHPA 1043 | | |
| JA | | |
| Ö f b | | |

| CLARA | | |
|---|--|--|
|  | | |
| * | | |
| AKT 06 SEHPA 1103 | | |
| JA | | |
| Ö f b | | |

| ŞARM | | |
|---|--|--|
|  | | |
| * | | |
| AKT 09 SEHPA 6107 | | |
| 4 ø# | | |
| Ö f b | | |

| ZAFIR | | |
|---|--|--|
|  | | |
| * | | |
| ÖRME SEHPA 840 | | |
| øJ | | |
| / f b | | |

| KNIT | | |
|---|--|--|
|  | | |
| * | | |
| ÖRGÜLÜ SEHPA (Q70) 6084 | | |
| u J | | |
| u ø_ | | |
| u 4 ø# | | |
| / f b | | |

| KNIT | | |
|---|--|--|
|  | | |
| * | | |
| ÖRGÜLÜ SEHPA (Q45) 6084 | | |
| J | | |
| ø_ | | |
| 4 ø# | | |
| Ö f b | | |

| SEYSELLER | | |
|---|--|--|
|  | | |
| * | | |
| TERAS ÜSTÜ SEHPA 124009 | | |
| øJ | | |
| / f b | | |

Sehpalar / Coffee Tables

Fiyat Listesi / Price List
USD

| MOON | | |
|---|--|--|
|  | | |
| x | | |
| GARDEN KÜTÜK SEHPA 1313 | | |
| f h | | |
| | | |
| Ö f b | | |

| VARDE | | |
|---|--|--|
|  | | |
| x | | |
| VARDE SEHPA 1204 | | |
| f h | | |
| | | |
| Ö f b | | |

| SALY | | |
|---|--|--|
|  | | |
| x | | |
| SALY SEHPA 1214 | | |
| f h | | |
| | | |
| Ö f b | | |

| BUTTERFLY | | |
|---|--|--|
|  | | |
| * | | |
| AKT 10 SEHPA 6142 | | |
| JA | | |
| | | |
| Ö f b | | |

Dresuarlar / Sideboards

Fiyat Listesi / Price List
USD

| DIAMOND | | |
|---|--|--|
|  | | |
| * | | |
| DR01 801 | | |
| J | | |
| # | | |
| # | | |
| Ö f b | | |

| WING | | |
|---|--|--|
|  | | |
| * | | |
| DR02 802 | | |
| J | | |
| # | | |
| # | | |
| Ö f b | | |

| ZIGZAG | | |
|---|--|--|
|  | | |
| * | | |
| DR03 803 | | |
| J | | |
| # | | |
| # | | |
| Ö f b | | |

Puflar / Poufs

Fiyat Listesi / Price List
USD

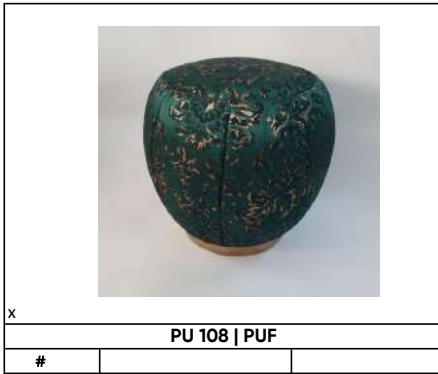
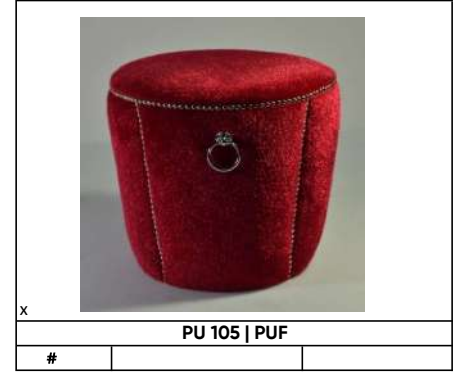
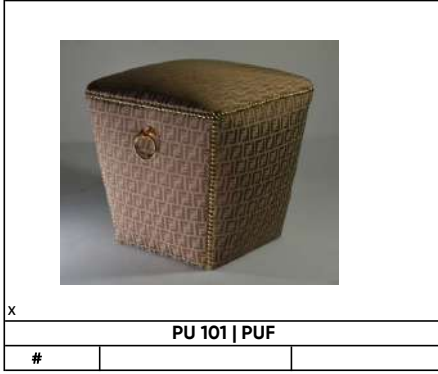

Puflar / Poufs

Fiyat Listesi / Price List
USD

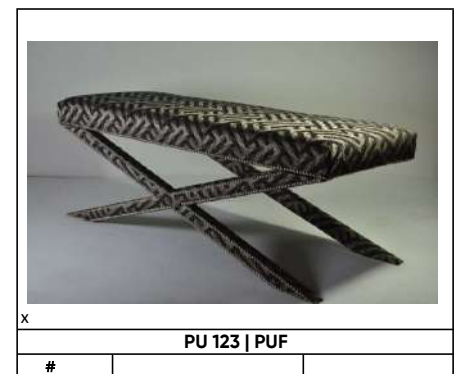
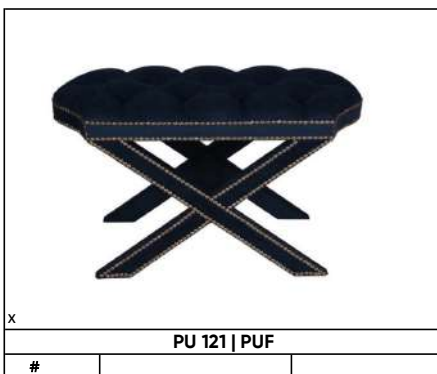
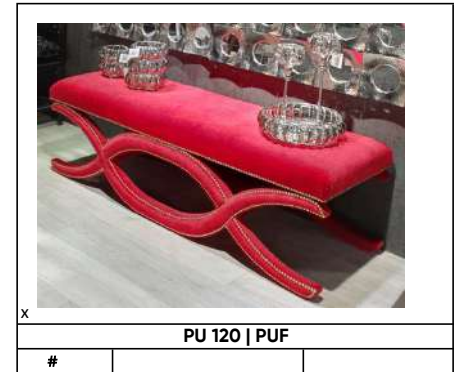
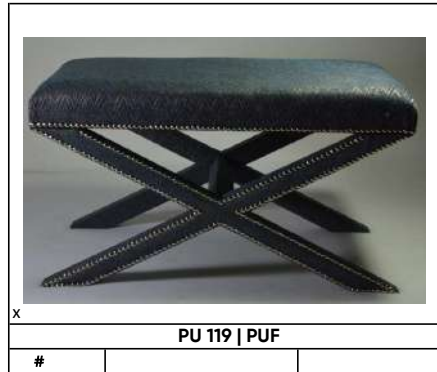
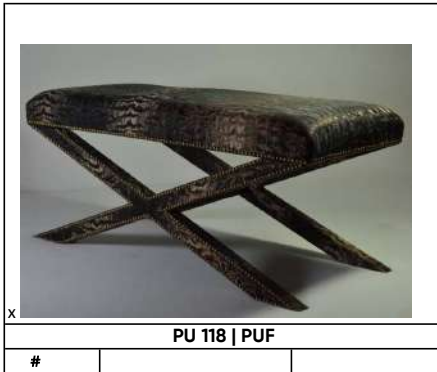
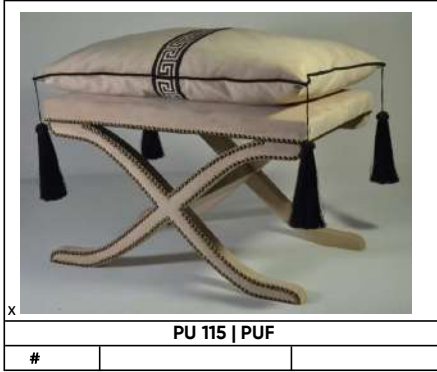

Puflar / Poufs

Fiyat Listesi / Price List
USD



X
PU 124 | PUF

| | | |
|---|--|--|
| # | | |
|---|--|--|



X
PU 125 | PUF

| | | |
|---|--|--|
| # | | |
|---|--|--|



X
PU 126 | PUF

| | | |
|---|--|--|
| # | | |
|---|--|--|



X
PU 127 | PUF

| | | |
|---|--|--|
| # | | |
|---|--|--|



X
PU 128 | PUF

| | | |
|---|--|--|
| # | | |
|---|--|--|



X
PU 129 | PUF

| | | |
|---|--|--|
| # | | |
|---|--|--|



X
PU 130 | PUF

| | | |
|---|--|--|
| # | | |
|---|--|--|



X
PU 131 | PUF

| | | |
|---|--|--|
| # | | |
|---|--|--|



X
PU 132 | PUF

| | | |
|---|--|--|
| # | | |
|---|--|--|

Puflar / Poufs

Fiyat Listesi / Price List
USD

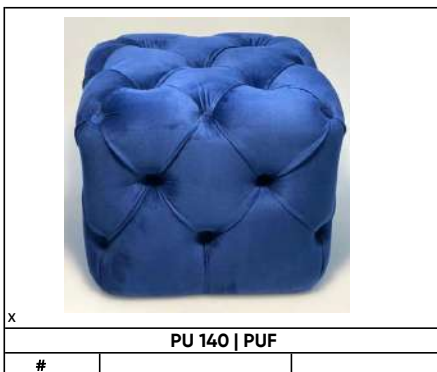
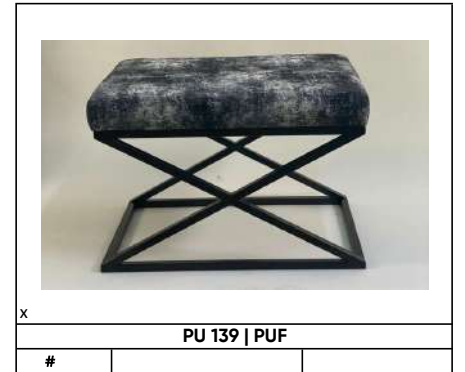
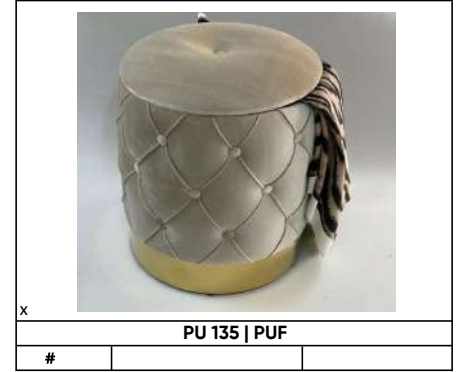

Puflar / Poufs

Fiyat Listesi / Price List
USD

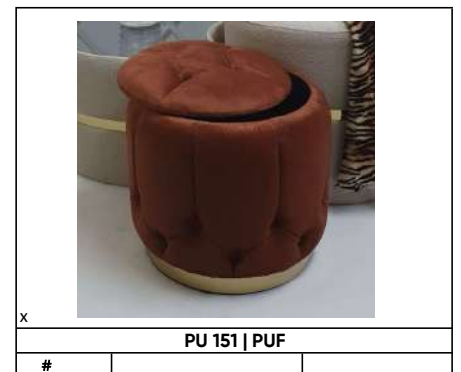
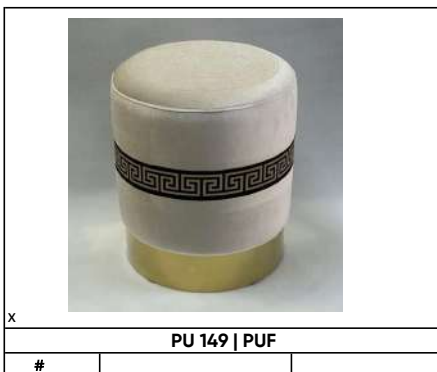

Puflar / Poufs

Fiyat Listesi / Price List
USD

