



Sectional Doors **Fire Rated Doors**

Fire-rated Industrial Doors

Special Doors **Ballistic Doors** Acoustic Doors

Hangar Doors **Garage Doors**

Explosion-proof Doors Industrial Fire Doors





Fire Doors **Sectional Doors**



Fire-rated Industrial Doors **Special Doors**



Dimak Door and Door Systems has 25 years of experience in door business. Dimak Door, which has completed numerous prestigious domestic and international projects, offers unique **fire door solutions** for your projects. Dimak Door and Door Systems continues to offer high quality solutions provided by **high technology production process** focused on customer satisfaction with its growing staff and production volume.

Why Dimak?

-  **Reliable Partner**
Keeping always his word
-  **Timing**
The best timing in production, assembly, service when bidding
-  **Customer Satisfaction**
High customer satisfaction in sales and after sales services
-  **Solution Oriented**
Approach to create a “solution” rather than a “problem”

-  **R&D Engineering**
Experienced engineers to develop new products
-  **Flexible Production**
Solutions for every project with its flexible production structure
-  **Innovative Technology**
Latest technology and application techniques for production
-  **Project Management**
Capacity to finalize large-scale projects

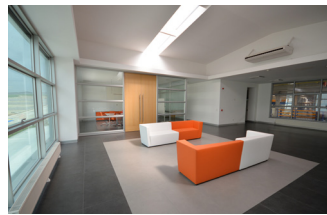
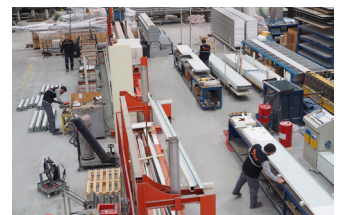
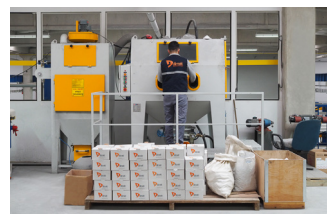



60 Minute Fire Resistance Certification



90 Minute Fire Resistance Certification



120 Minute Fire Resistance Certification

The fire doors produced by Dimak, which has always been aware of the importance of quality in the global market as a strategic factor for business success, are tested according to **EN 1634-1 standards**.



900x2050 mm / 1000x2050 mm
900x2100 mm / 1000x2100 mm
900x2150 mm / 1000x2150 mm



Max. 1300x2650 mm single leaf doors
Max. 2600x2650 mm double leaf doors



2050-2100-2150 mm opening heights

*Standard size doors are reversible (left&right)

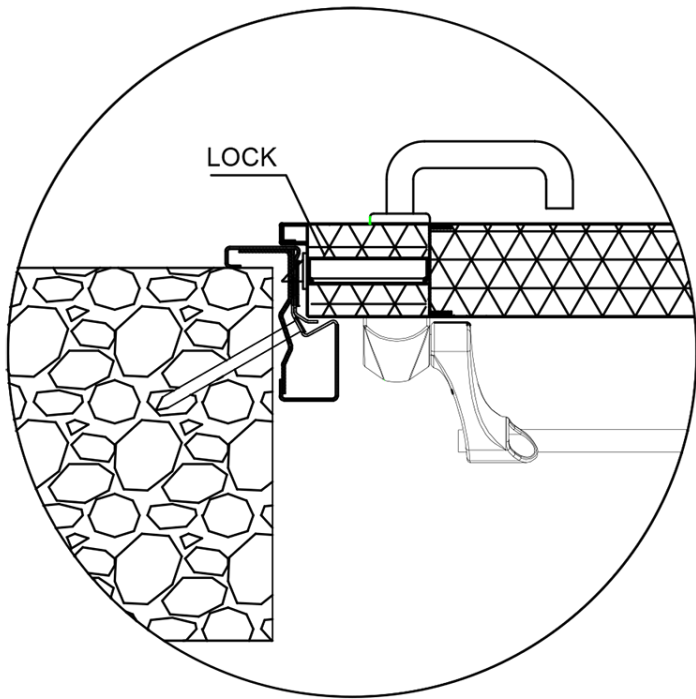

Corner Frame



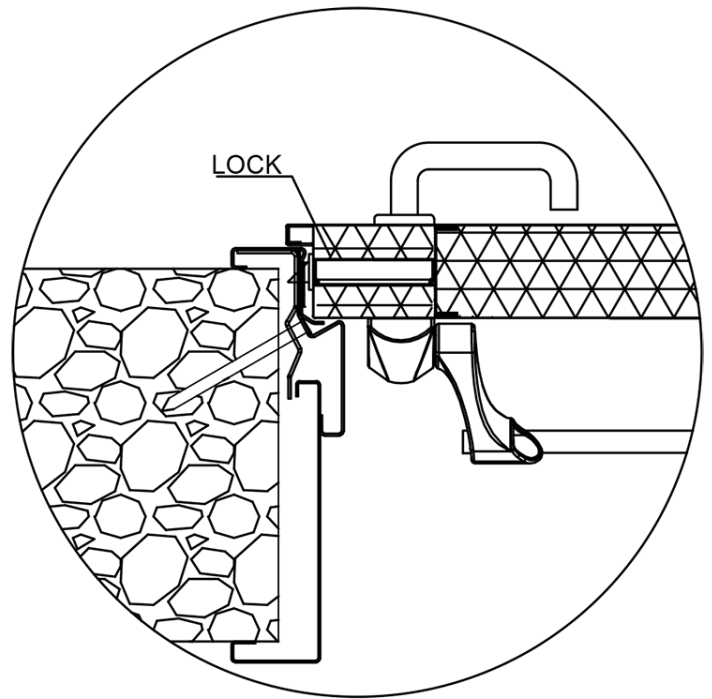

The fire doors with corner frames are suitable for any wall thickness as a standard.







Full Frame

The fire doors can be produced with full frame option that covers the whole wall with extra frame profiles.

Frames and Leaves

-  **Rigidity**
Unique sectional design makes the frame and leaf very rigid
-  **Modular Design**
Door frames are produced in 3 disassembled pieces
-  **Fire Seals**
High-quality intumescent seals on the frame
-  **Air and Sound Insulation**
On request, air and sound insulating seals provided

-  **Optional Hardware**
Supporting plates are present inside the door leaf for installation of optional hardware
-  **Strength**
Door leaf thickness is 63 mm
-  **Safety Bolts**
There are two safety bolts per leaf on the hinge side
-  **Weather Seal Slots**
Weather seal slots are present on the door frame

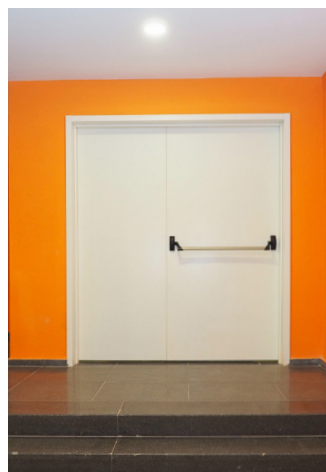



Electrostatic Powder Coating

Dimak fire doors are coated in a modern robotic electrostatic powder coating line. While standard color is RAL 9002, any requested RAL color can be applied. Fire door frame and leaf may be in different RAL colors as well as inner and outer of leaf.

For a better powder penetration, galvanized steel which has a special surface is used. Due to galvanized steel usage in production of leaves and frames, fire rated steel doors have high corrosion resistance. Fire doors are coated with polyester electrostatic powder which is appropriate for both outdoor and indoor usage providing UV resistance.





Fire Rated Steel Door **Accessories**

- ✓ The doors are equipped with heavy-duty hinges with ball bearing (one).
- ✓ Hardware used on Dimak doors are all top quality with incomparable unique functions not existing in the market.
- ✓ Locks are specially designed to be used as left/right and panic/anti-panic.
- ✓ Handle and panic bar are cast aluminium (rust proof) which can be used in all climate conditions.
- ✓ Doors are supplied with lock, handles (or panic hardware), euro cylinders and 3 keys.
- ✓ Handle+lock+handle or panic hardware are installed as a mono-block hardware system where 4 long bolts pass through the holes on the lock making a very rigid connection to handles and panic hardware otherside.
- ✓ One of the hinges is self-closing (spring hinge) which keeps the door closed all times.
- ✓ Fire rated windows can be applied on leaves on request. Stock sizes are 500 x 500 mm and 300x400 mm.
- ✓ By use of a setscrew the lock can be switched to panic from anti-panic.
- ✓ Standard hardware color is black however any RAL color is possible for high volume orders.
- ✓ Louvers with acceptable sizes may be applied on request.
- ✓ Due to mono-block hardware system, it is not possible that the handles are tearing out of the doors due to harsh usage and gives the fire door and hardware set durability and long life.

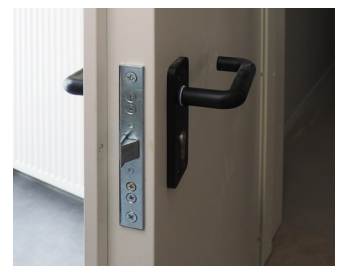



High Quality Packaging

All door frames and leaves are packaged using **high thickness packing** nylon. Nylon packaging of door leaves can be kept on after the installation of the doors. By this way, the doors will not be damaged by the painting or plaster repairs done after the installation. The doors are shipped on pallets. **15 sets of single doors** can be packed on each pallet. The **disassembled design of door frames** yields serious shipping advantage.





Fire Door Installation

- ✓ There is no need for extra metal profile frames which yields cost advantage.
- ✓ By the use of floor mounting brackets (specially developed based on experience) the vertical frame profiles can be fixed to the floor which creates a rigid connection between the door frame and the construction structure. As a result, problems such as twisting of the bottom part of the frame do not arise on the long run.
- ✓ Each door frame is installed by the use of universal dowels (optional delivery) directly to the wall.
- ✓ Modular door frame providing significant transportation advantage and practical assembly is designed to be assembled in 3 parts.



Full Specifications of Dimak Fire Doors

- Tested according to EN 1634-1 & UL 10c standards
- Certification for 60 , 90 and 120 minutes fire rating
- Produced in both standard and customer-specific sizes
- Constantly stocked on standard sizes (quick delivery in standard sizes)
- Standard sizes (wall opening dimensions)**
 - 900 x 2050 mm / 1000 x 2050 mm
 - 900 x 2100 mm / 1000 x 2100 mm
 - 900 x 2150 mm / 1000 x 2150 mm
- Doors of heights 2050/2100/2150 mm are reversible (Left&Right)
- This possibility eliminates the directional mistakes made in the construction work sites, moreover the ordering process is faster and much more practical.
- The doors are coated with electrostatic powder coating process in our modern robotic coating line.
- The standard color is RAL 9002, however any requested RAL color can be applied.***
- The door frame and the door leaf can be coated in different RAL colors.
- The interior and exterior of the door leaf can also be coated in different colors.***
- Door leaf has 63 mm thickness and produced from 0.80 mm thick galvanised steel.
- Door frame is produced from 1.50 mm galvanized steel.
- Galvanized steel is used in the production of door frames and door leaves therefore the doors are highly enduring to corrosion.
- The galvanized steel has a special surface suitable for electrostatic powder coating.
- Due to its unique sectional design, the door frame and door leaf are very rigid.
- High-quality thermo expanding (intumescent) seal on the frame.
- Weather seal slots are present on the door frame. Depending on the customer demands, air and sound insulating seals are also provided.***
- The doors are equipped with heavy-duty hinges with ball bearing (one).
- One of the hinges is self-closing (spring hinge). This hinge keep the door constantly closed.
- There are two safety bolts per leaf on the hinge side.
- Coordinator can be installed to the double winged doors in order for the door leaves to close in coordination.***
- Each door frame is installed using 10 universal dowels directly to the wall. There is no need for extra metal profile frames which yields cost advantage. Delivery of dowels are optional.***
- By the use of floor mounting brackets (specially developed based on experience) the vertical frame profiles can be fixed to the floor. This creates a rigid connection between the door frame and the construction structure. As a result, problems such as twisting of the bottom part of the frame do not arise in the following periods.
- Supporting plates are present inside the door leaves for installation of optional equipment. (e.g. door closer)
- Door frames are designed in 3 disassembled pieces. The installation of these 3 pieces is very practical (as practical as the assembly of Lego pieces). The disassembled design of door frames yields serious shipping advantage.
- All door leaves and door frames are wrapped in nylon packaging of high thickness. The nylon packaging of door leaves can stay on after the installation of the doors. So, the doors will not be harmed by the painting processes or plaster repairs carried out after the installation.
- The doors are packed on palettes. 15 sets of single leaf doors can be packaged on each palette.
- The fire doors have half (corner) frames suitable for any wall thickness as a standard. If a full frame is requested, the fire doors can be made suitable for a full frame covering the whole wall with the extra profile frames provided.***
- For doors which will be used with an access control unit, top quality electrical strike (tested for 1 million cycles) can be applied during production as an optional accessory.***
- Windows are possible. Stock sizes are 500 x 500 mm and 300x400 mm.***
- Aluminium or fire-rated louvers may be applied on request.***
- Dimak Hardware used on the doors are all very high quality with incomparable functions not existing in the market.
- Doors are supplied with lock, handles (or panic hardware) euro cylinders and 3 keys.
- Lock specially designed to be used in left and right doors.
- Lock has double function; panic and anti-panic.
- By use of a setscrew the lock can be switched to panic from anti-panic.
- So in case you need to change the handle+lock+handle door to a panic hardware door it is possible without ordering extra lock.
- Handle+lock+handle or panic hardware are installed as a mono block hardware system where 4 long bolts pass through the holes on the lock and makes a very rigid connection to handles and panic hardware otherside. Due to this mono-block hardware system it is not possible that the handles are tearing out of the doors due to harsh usage and gives the fire door and hardware set durability and long life.
- Handle and panic bar are cast aluminium (rust proof) which can be used in all weather conditions.
- Standard hardware color is black however any RAL color is possible for high volume orders.***

*** Subject to extra charges



Anadolu Organize Sanayi Bölgesi
30 Ağustos Cad. No:26, Malıköy
Sincan 06909 Ankara, TURKEY

T: +90 312 554 50 50 F: +90 312 554 50 54



dimakfiredoors.com
dimak@dimak.com.tr

Sectional Doors **Fire Rated Doors**

Fire-rated Industrial Doors

Special Doors Ballistic Doors Acoustic Doors

Hangar Doors Garage Doors

Explosion-proof Doors Industrial Fire Doors

Fire Doors **Sectional Doors**

Fire-rated Industrial Doors **Special Doors**