

MAKİNA TEKNİK VERİLERİ / MACHINE TECHNICAL DETAILS

Blok Sayısı / <i>Capstan No</i>	: 3-14
Blok Çapı / <i>Capstan Dia</i>	: 400 - 710 mm
Giriş Tel Çapı / <i>Inlet Wire Dia</i>	: 8,00 mm Max
Çıkış Tel Çapı / <i>Outlet Wire Dia</i>	: 1,3 mm Min
Hız / <i>Speed</i> (2,5-5 mm)	: 12 m/s
Hız / <i>Speed</i> (1,3-2,5 mm)	: 18 m/s

Otomasyon Kontrol / Automation Control

SIEMENS

Elektrik Motorları / Electrical Motor

SIEMENS

Redüktörler / Reducers



Valf ve Hava Ekipmanları / Valve and Air Equipment



Rulmanlar / Bearings



SAN. YEDEK PARÇA HAF. TİC. LTD. ŞTİ.
www.kocabeymakina.com.tr

Organize Sanayi Bölgesi, Ceyhan Yolu Üzeri, Sarıçam / Adana / TÜRKİYE
Tel.: +90 322 - 394 3178 • 394 3010 • 394 3070 • Fax: +90 322 - 394 3279
info@kocabeymakina.com.tr
GSM: +90 532-156 7889



SAN. YEDEK PARÇA HAF. TİC. LTD. ŞTİ.

KCM 300

TEL ÇEKME MAKİNASI • WIRE DRAWING MACHINE

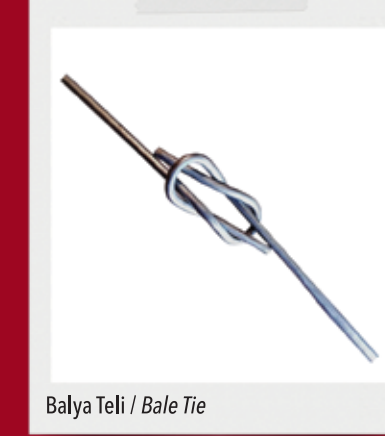

Balya Teli / Bale Tie



Bağ Teli / Tie Wire



Çivi / Nail



Galvanizli Tel / Galvanized Wire

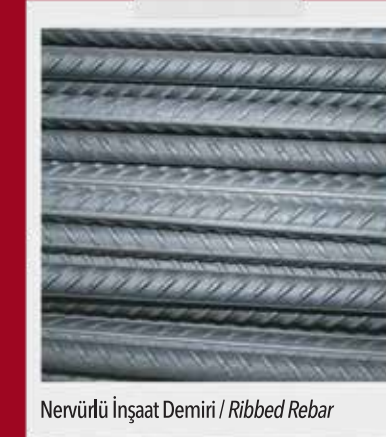

Nervürlü İnşaat Demiri / Ribbed Rebar

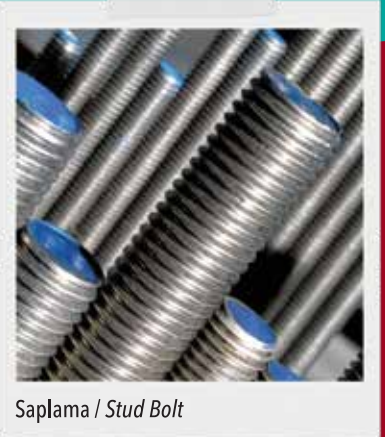

Saplama / Stud Bolt



Çekilmiş Son Ürün / Cold Drawn Final Product



Çelik Hastr / Wire Mesh



Panel Tel Çit / Wire Fence

KCM 300

TEL ÇEKME MAKİNASI

Wire Drawing Machine

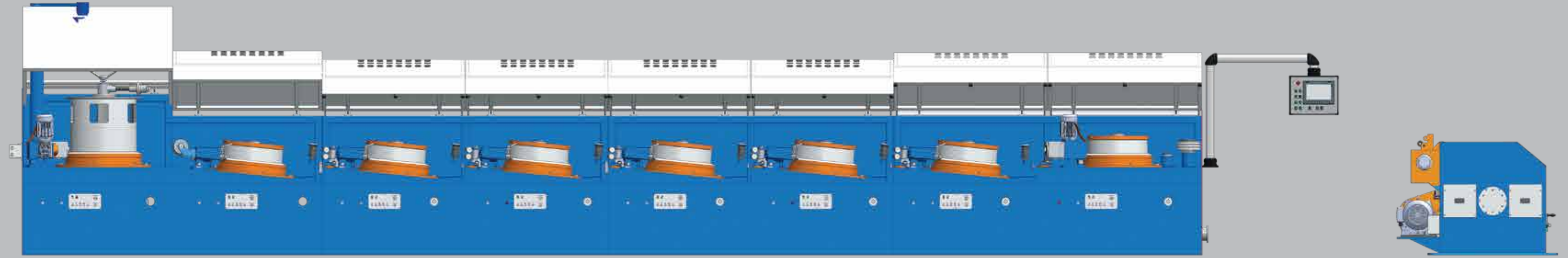
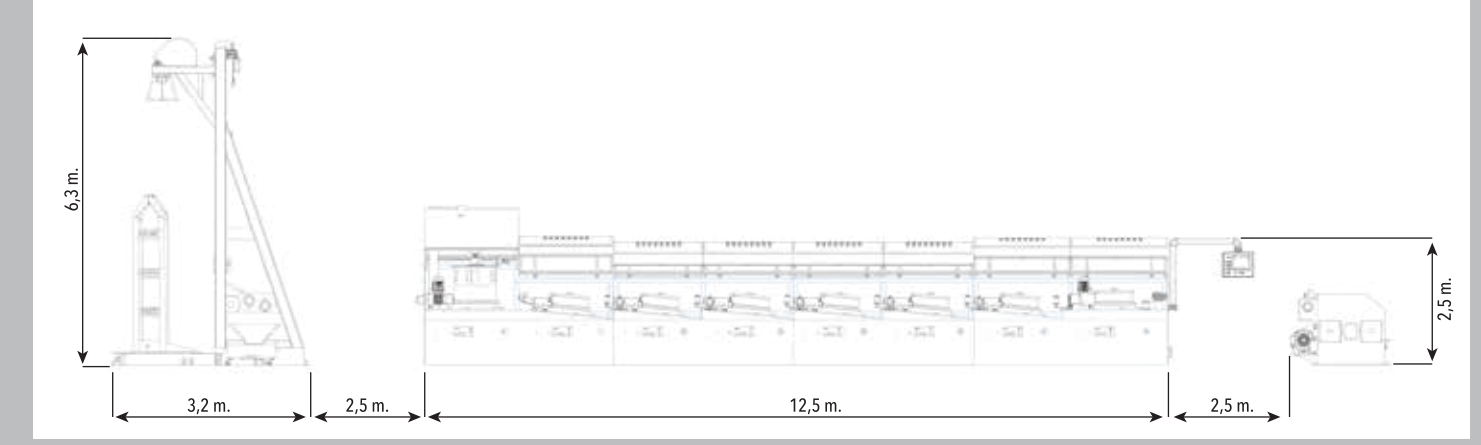
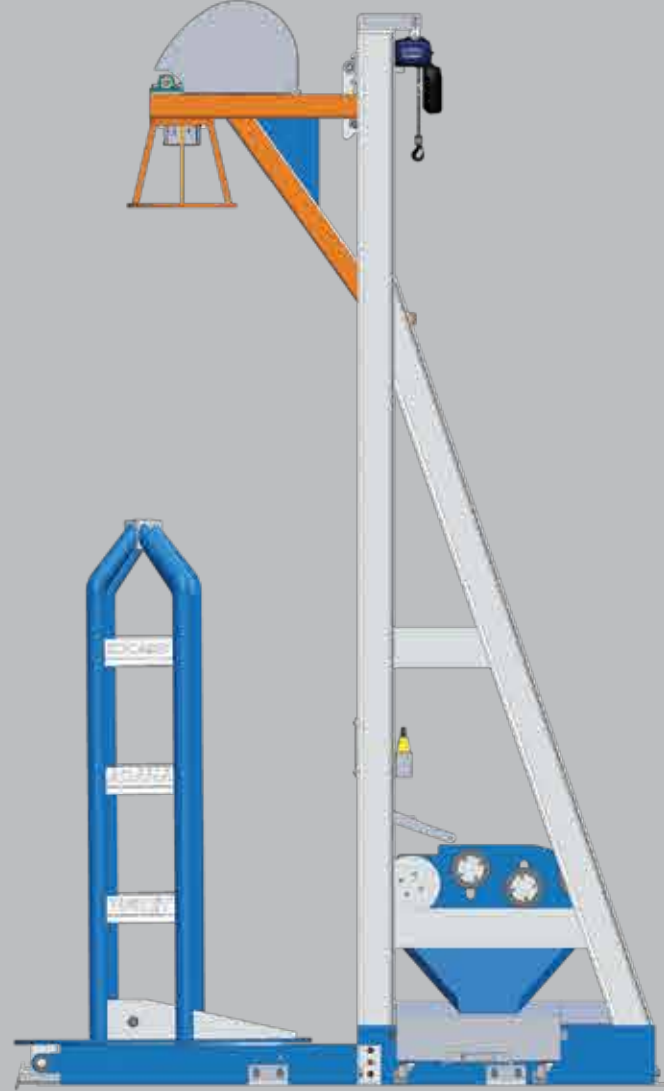

Döner Hadde
Rotary Roller



Ø700 Tambur
Ø700 Capstan

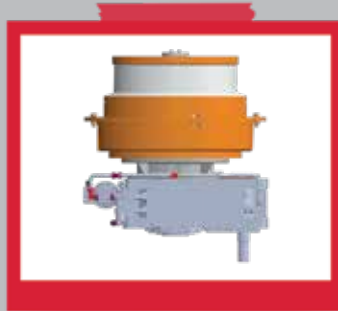

Ø600 Tambur
Ø600 Capstan

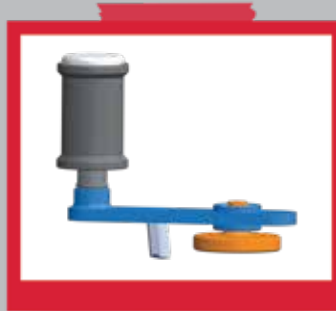

Blok Dancer
Block Dancer



Sabit Hadde
Fixed Rolling



Hareketli Dancer
Movable Dancer

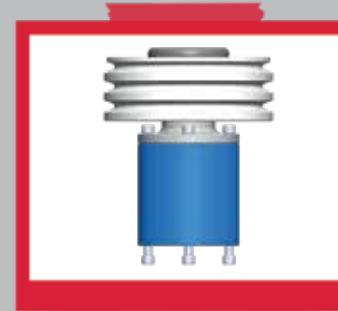

Sabit Dancer
Fixed Dancer



Coiler

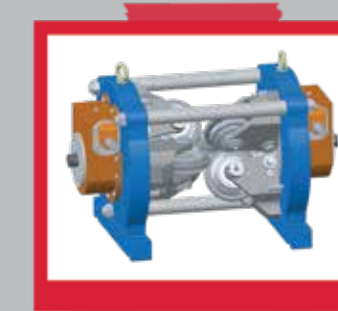

Kaset
Cassette

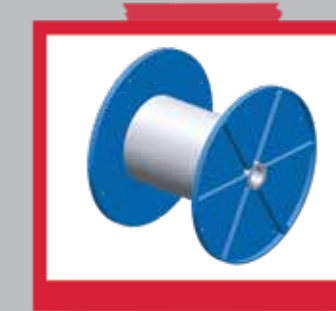

Sabit Makara
Fixed Reel

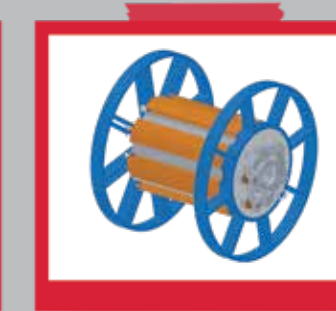

Portatif Makara
Portable Reels



Uç Açma Makinesi
Wire Pointing Machine