

 **MİNYATÖR MAKİNA**
MİNYATÖR ÜRETİM VE SATIŞI İÇİN
KURULAN VE İŞLETİLEN BİR ŞİRKETTİR.





MINYATUR MACHINE

Robot Systems and Automation

Our company has a proven track record in the field of metal processing. We offer expertise in machinery and metal cutting, apparatus, specific custom machines, fixtures, robotic systems, and automation. We believe in the concept of turning your ideas into reality by standardizing products and minimizing errors.

To learn more, please feel free to contact us.

With our commitment to delivering exceptional service, we strive to offer not just what is expected, but to provide more controlled power and advanced technology. In doing so, we aim to always be at the forefront regarding personnel and technology."



MINYATUR MACHINE

Robot Systems and Automation

**PROJECT
SPECIFIC MACHINES**

**HYDRAULIC AND
PNEUMATIC
APPARATUS**

**WHAT ARE WE
DOING ?**

**ON CNC MACHINE
PRODUCTION**

**MANUFACTURING OF
MEASURING
APPARATUS AND
GAUGES**



MINYATUR MACHINE

Robot Systems and Automation

01

BIDDING PHASE:WE OFFER YOUR PROJECT AFTER MEETINGS

01

02

02

DESIGN PHASE:WE DESIGN THE PROJECT TOGETHER WITH OUR EXPERT DESIGN TEAM AND CUSTOMER

03

03

ASSEMBLY PHASE:WE DO PRODUCTION AND INSTALLATION AFTER THE PROJECT DESIGN APPROVAL

04

04

COMMISSIONING PHASE:WE DO TURN-KEY COMMISSIONING ON THE FIELD

HOW WE DO?



MINYATUR MACHINE

Robot Systems and Automation

OUR MACHINERY





MİNYATÜR MACHİNE

Robot Systems and Automation

OUR MACHINERY

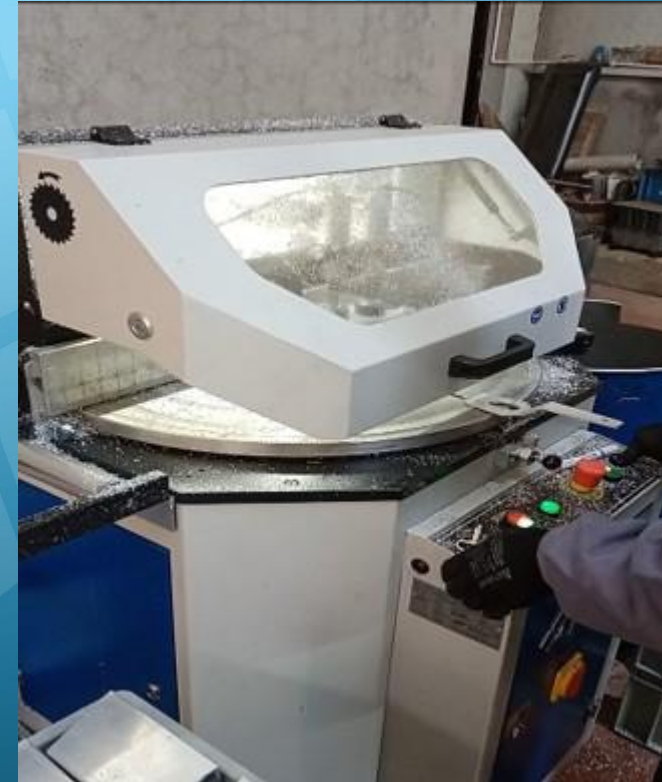



MINYATUR MACHINE

Robot Systems and Automation

OUR MACHINERY





MINYATUR MACHINE

Robot Systems and Automation

ROBOT BUSHING PROJECT





MINYATUR MACHINE

Robot Systems and Automation

PNEUMATIC HOLDER PROJECT

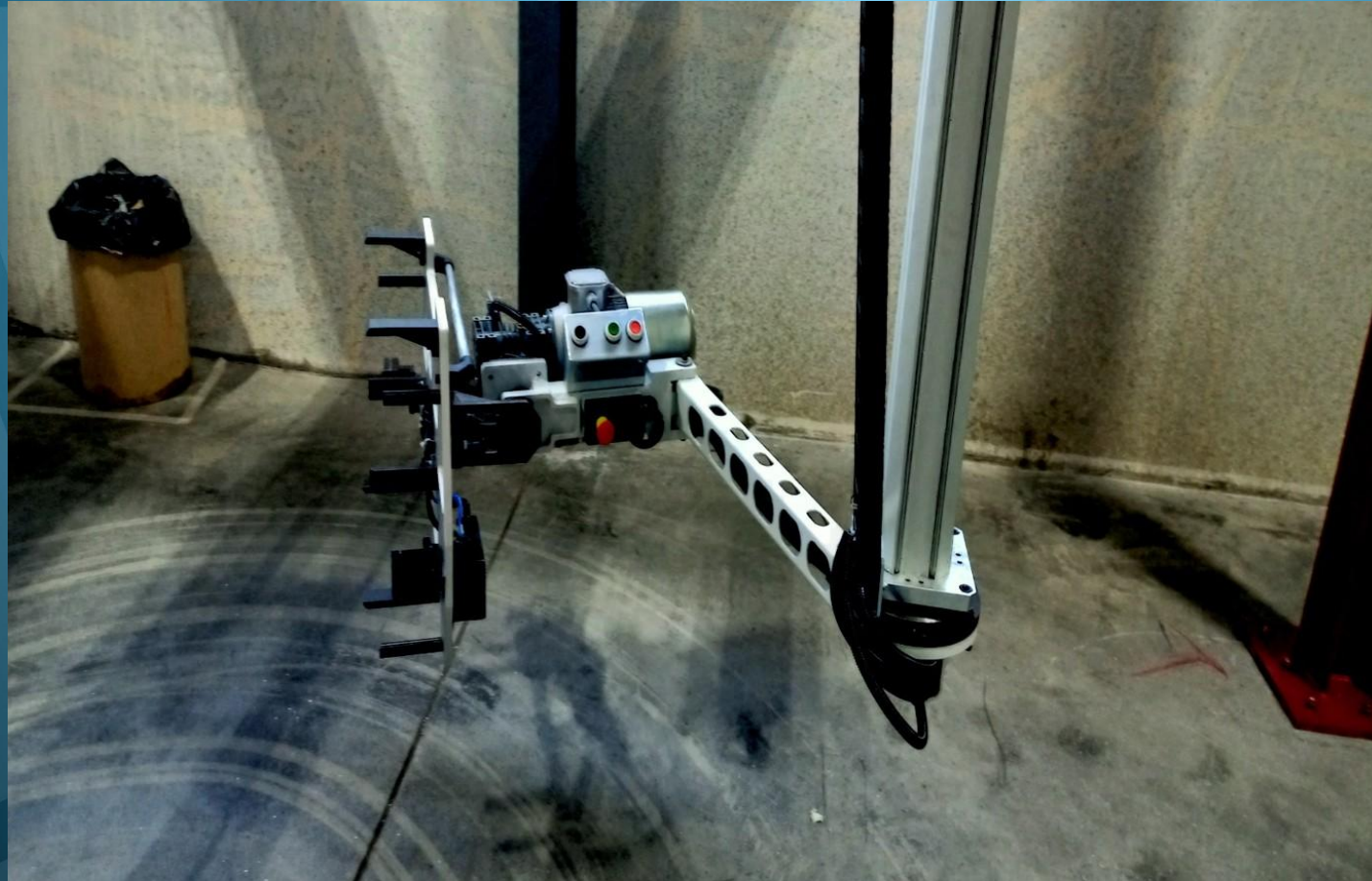



MINYATUR MACHINE

Robot Systems and Automation

LIGHTING ASSEMBLY MACHINE





MINYATUR MACHINE

Robot Systems and Automation

SILICONE COATING CABINET REVISION





MINYATUR MACHINE

Robot Systems and Automation

BRACELET CLAMPING MACHINE





MINYATUR MACHINE

Robot Systems and Automation

END of LINE (Product Measurement and Control)





MINYATUR MACHINE

Robot Systems and Automation

THE FIXTURE OF ALUMINUM WELD

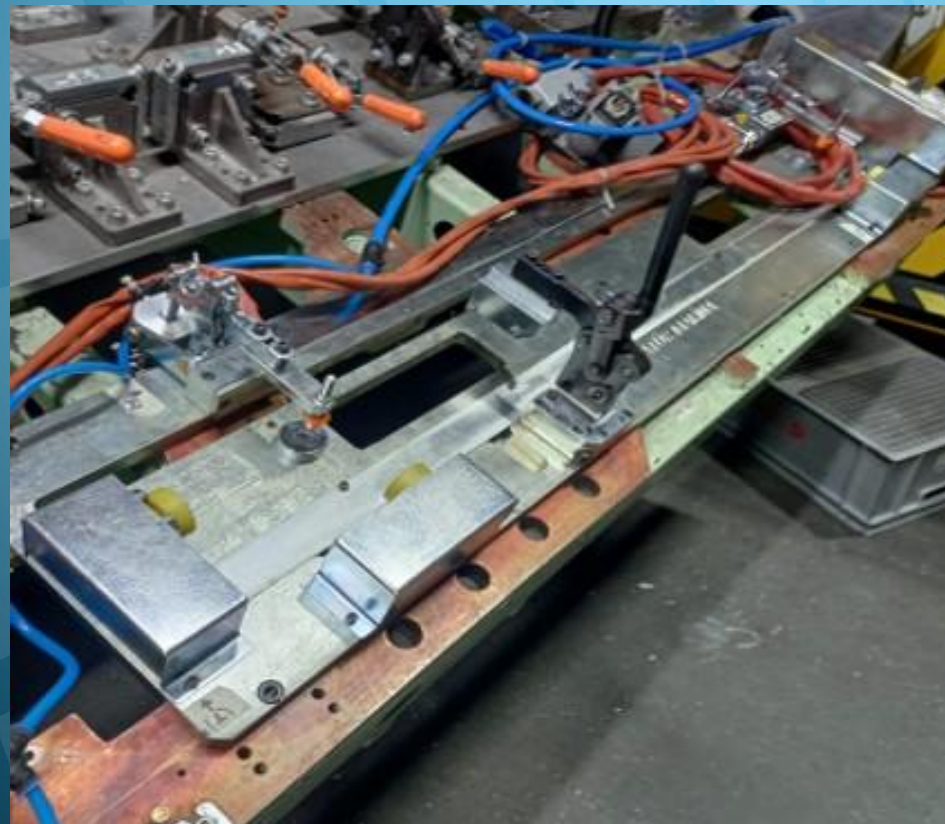



MINYATUR MACHINE

Robot Systems and Automation

CONTROL FIXTURES 3500mm LONG 0,2mm PRECISION

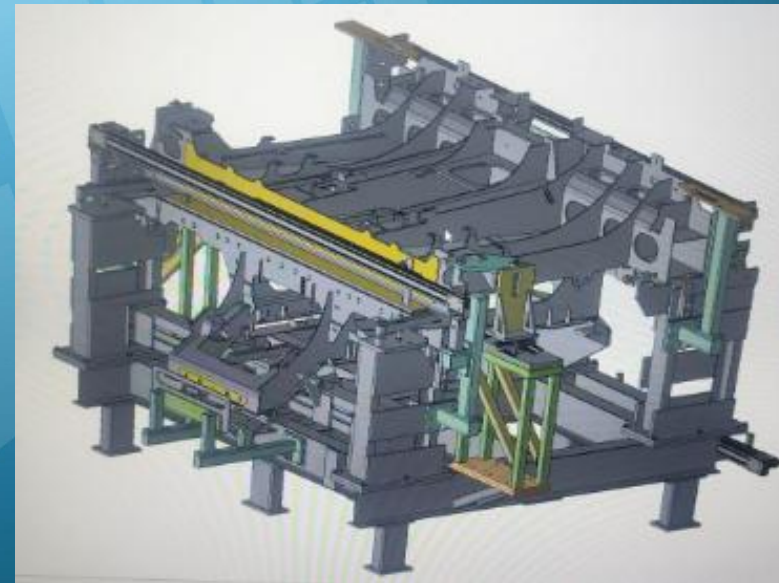



MINYATUR MACHINE

Robot Systems and Automation

HYDRAULIC CNC MACHINING FIXTURE



- Pistons with various pressures and types
- Pressure sequence valves
- Expansion valves
- Piece Positioning
- The positioning point of the piece
- verified binding for the piece

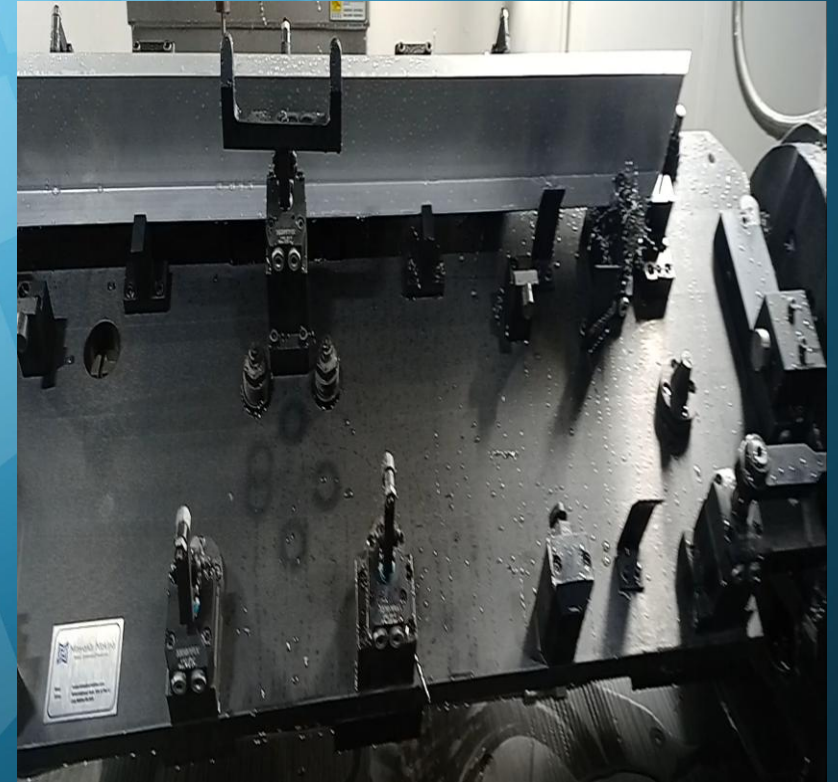



MINYATUR MACHINE

Robot Systems and Automation

MANUFACTURING PARTS

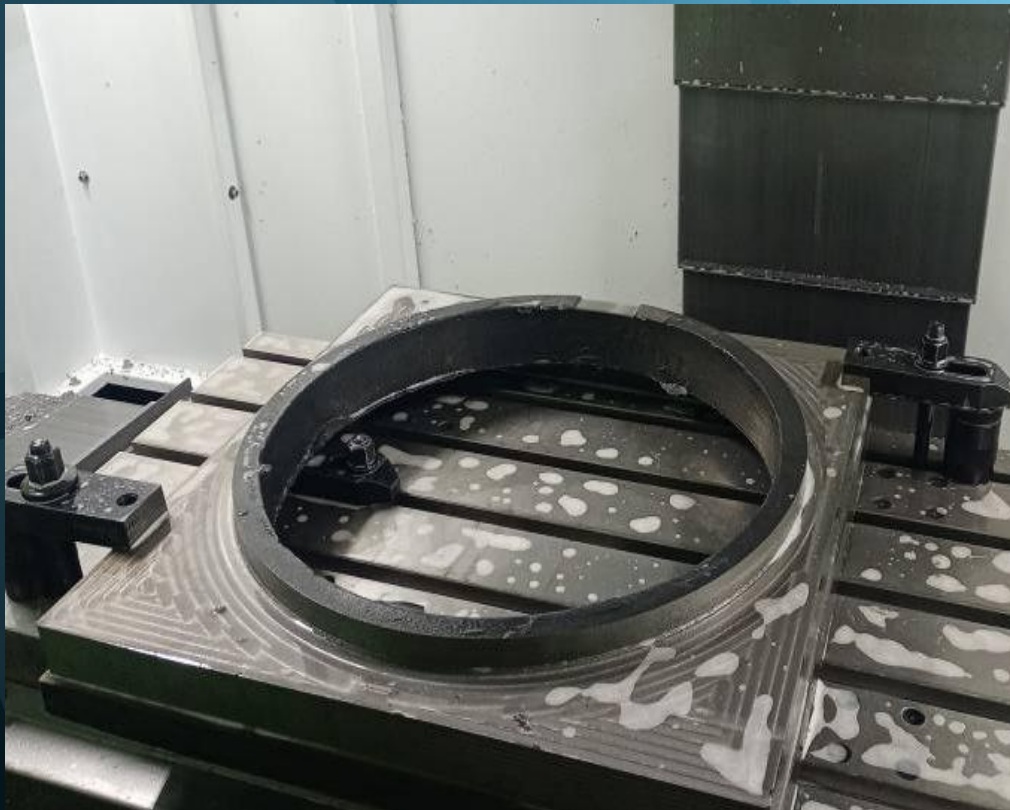



MINYATUR MACHINE

Robot Systems and Automation

MANUFACTURING PARTS





MINYATUR MACHINE

Robot Systems and Automation

MANUFACTURING PARTS

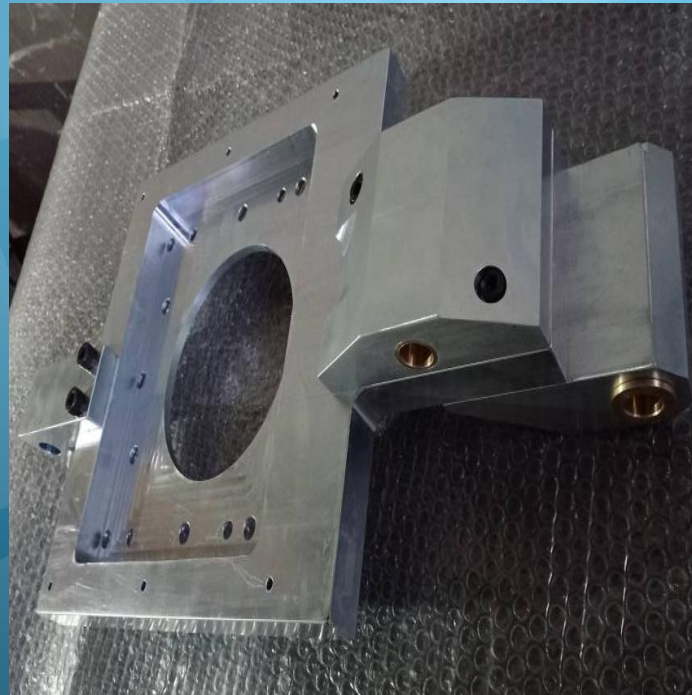



MINYATUR MACHINE

Robot Systems and Automation

DESIGNSOLID
WORKS

ASSEMBLY

SOFTWARE

DEPLOYMENT.

SOME of OUR REFERENCES



TOFAŞ

TÜRK OTOMOBİL FABRİKASI A.Ş.



STANDARD PROFİL

Vibracoustic



**ERKURT
HOLDİNG**

**CANRAY
ULAŞIM**



cimtas

ALSTOM

TORQUE



**CANSAN
METALURJİ**

**CANEL
OTOMOTİV**

BURSALI

a-plas

**COŞKUNÖZ
HOLDİNG**



OUR STANDARDS



CERTIFICATE

MİNYATÜR MAKİNA
ROBOT SİSTEMLERİ OTOMASYON
SANAYİ TİCARET LİMİTED ŞİRKETİ

MİNARELİCAVUŞ MAH. 101. (290) SOK. E BLOK NO:41
NİLÜFER / BURSA / TÜRKİYE

*Has been assessed and found to comply with the requirements of:
Denetlenmiş ve aşağıdaki standartın gerekliliklerine uygunluğu görülmüştür:*

ISO 45001:2018

*The Occupational Health and Safety Management System is applicable to:
İş Sağlığı Ve Güvenliği Yönetim Sistemi:*

SALES OF MACHINERY, FURNITURE, BODY, HAND TOOLS, FITTINGS FROM
PLASTIC, CARRIER BELTS AND CONVEYOR BELTS FROM PLASTIC

MAKİNA, MOBİLYA, KAPORTA, EL ALETLERİ, PLASTİKTEN BAĞLANTI
PARÇALARI, PLASTİKTEN TAŞIYICI BANTLARIN VE KONVEYÖR
BANTLARININ SATIŞI

Certificate Number: OHSMS-002657
Belge Numarası: OHSMS-002657

Initial Certification Date: 12.05.2025
İlk Belgelendirme Tarihi: 12.05.2025

Certification Period: 3 Years
Belgelendirme Periyodu: 3 Yıl

Certificate Validity Date: 11.05.2026
Belge Geçerlilik Tarihi: 11.05.2026

QMS

IQR Sertifikasyon Dağıtım



IAS

ACCREDITED
Management Systems
Certification Body
MSCB-135

IQR ULUSLARARASI BELGELENDİRME HİZMETLERİ LTD.ŞTİ.
Büyükdere Mah. Kocayusu Sk. No:3 Anadolı Han Plaza K:2 Nilüfer / BURSA
Tel.: +90.224.288 00 16 Faks: +90.224.249 41 13 www.iqrort.com e-posta: info@iqrort.com



CERTIFICATE

MİNYATÜR MAKİNA
ROBOT SİSTEMLERİ OTOMASYON
SANAYİ TİCARET LİMİTED ŞİRKETİ

MİNARELİCAVUŞ MAH. 101. (290) SOK. E BLOK NO:41
NİLÜFER / BURSA / TÜRKİYE

*Has been assessed and found to comply with the requirements of:
Denetlenmiş ve aşağıdaki standartın gerekliliklerine uygunluğu görülmüştür:*

ISO 14001:2015

*The Environmental Management System is applicable to:
Çevre Yönetim Sistemi:*

MANUFACTURING OF MACHINERY, FURNITURE, BODY, HAND TOOLS, FITTINGS
FROM PLASTIC, CARRIER BELTS AND CONVEYOR BELTS FROM PLASTIC

MAKİNA, MOBİLYA, KAPORTA, EL ALETLERİ, PLASTİKTEN BAĞLANTI
PARÇALARI, PLASTİKTEN TAŞIYICI BANTLARIN VE KONVEYÖR
BANTLARININ İMALATI

Certificate Number: EMS-007938
Belge Numarası: EMS-007938

Initial Certification Date: 12.05.2025
İlk Belgelendirme Tarihi: 12.05.2025

Certification Period: 3 Years
Belgelendirme Periyodu: 3 Yıl

Certificate Validity Date: 11.05.2026
Belge Geçerlilik Tarihi: 11.05.2026

QMS

IQR Sertifikasyon Dağıtım



IAS

ACCREDITED
Management Systems
Certification Body
MSCB-135

IQR ULUSLARARASI BELGELENDİRME HİZMETLERİ LTD.ŞTİ.
Büyükdere Mah. Kocayusu Sk. No:3 Anadolı Han Plaza K:2 Nilüfer / BURSA
Tel.: +90.224.288 00 16 Faks: +90.224.249 41 13 www.iqrort.com e-posta: info@iqrort.com



CERTIFICATE

MİNYATÜR MAKİNA
ROBOT SİSTEMLERİ OTOMASYON
SANAYİ TİCARET LİMİTED ŞİRKETİ

MİNARELİCAVUŞ MAH. 101. (290) SOK. E BLOK NO:41
NİLÜFER / BURSA / TÜRKİYE

*Has been assessed and found to comply with the requirements of:
Denetlenmiş ve aşağıdaki standartın gerekliliklerine uygunluğu görülmüştür:*

ISO 9001:2015

*The Quality Management System is applicable to:
Kalite Yönetim Sistemi:*

MANUFACTURING OF MACHINERY, FURNITURE, BODY, HAND TOOLS, FITTINGS
FROM PLASTIC, CARRIER BELTS AND CONVEYOR BELTS FROM PLASTIC

MAKİNA, MOBİLYA, KAPORTA, EL ALETLERİ, PLASTİKTEN BAĞLANTI
PARÇALARI, PLASTİKTEN TAŞIYICI BANTLARIN VE KONVEYÖR
BANTLARININ İMALATI

Certificate Number: QMS-007938
Belge Numarası: QMS-007938

Initial Certification Date: 12.05.2025
İlk Belgelendirme Tarihi: 12.05.2025

Certification Period: 3 Years
Belgelendirme Periyodu: 3 Yıl

Certificate Validity Date: 11.05.2026
Belge Geçerlilik Tarihi: 11.05.2026

QMS

IQR Sertifikasyon Dağıtım



IAS

ACCREDITED
Management Systems
Certification Body
MSCB-135

IQR ULUSLARARASI BELGELENDİRME HİZMETLERİ LTD.ŞTİ.
Büyükdere Mah. Kocayusu Sk. No:3 Anadolı Han Plaza K:2 Nilüfer / BURSA
Tel.: +90.224.288 00 16 Faks: +90.224.249 41 13 www.iqrort.com e-posta: info@iqrort.com



MINYATUR MACHINE

Robot Systems and Automation



MAIL

info@minyaturmakina.com
trade@minyaturmakina.com



WEB

www.minyaturmakina.com



ADDRESS

Geçit Mah.
Denizciler. Sk No:49
OSB/Osmangazi/BURSA/TÜRKİYE



TELEPHONE

+90 224 411 00 16
+90 545 516 48 80



MINYATUR MACHINE

Robot Systems and Automation

THANKS....