

VEMIS 
S T E E L

www.vemis.com.tr

VEMIS

S T E E L



ABOUT US

WORK WITH US, WORK IN TRUST

VEMIS STEEL, established in the year 2000, located in Hatay/İskenderun which is the core centre of the metal industry , aims to serve its customers as a reliable, a straightforward, a long term bussiness partner.

The steel industrty has been growing day by day in both production and consumption , and it is also very dynamic and changes very fast, In this respect VEMIS STEEL a fastmoving global company and determined to add value to its customers.We are exporting steel products from Turkey to different countries located all around the world such as Middle East, Africa, Europe ,Asia.

We will do our best to support our custumors with the right price, right shipment, and right quality.

HRC-CRC /HRS-CRS GROUP LES Toles & Bobines

ورقة

Smooth or Hammered

EN 10025-2 2004/ S235JR/S275JR/S355JR

Hot Rolled, Cold Rolled, Galvanized, Painted Steel Coils & Sheets

Coils, Sheets & Plates (Cut to length)

Slitted Strips

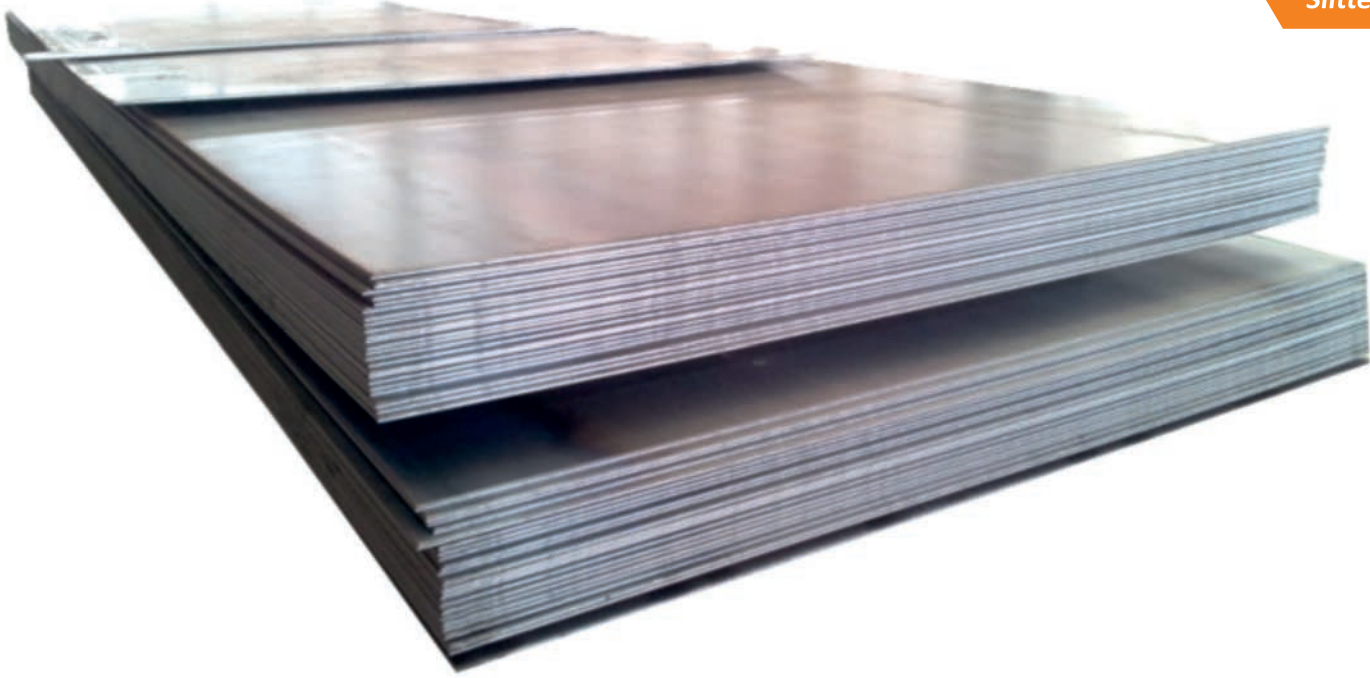

ITEM CODE	THICKNESS	WIDTH	LENGHT
HRC	2-10mm	max 2mt	max 12mt
GCRC	0,25-3mm	800-1530mm	max 6mt

• Different sizes, qualities, standards and length available.

• Différentes tailles, qualités, normes et longueurs disponibles

مختلفة والجودة, حجام, والطول, والمعايير, المتاحة

SQUARE BARS
Fer Carré
قضبان مربعة

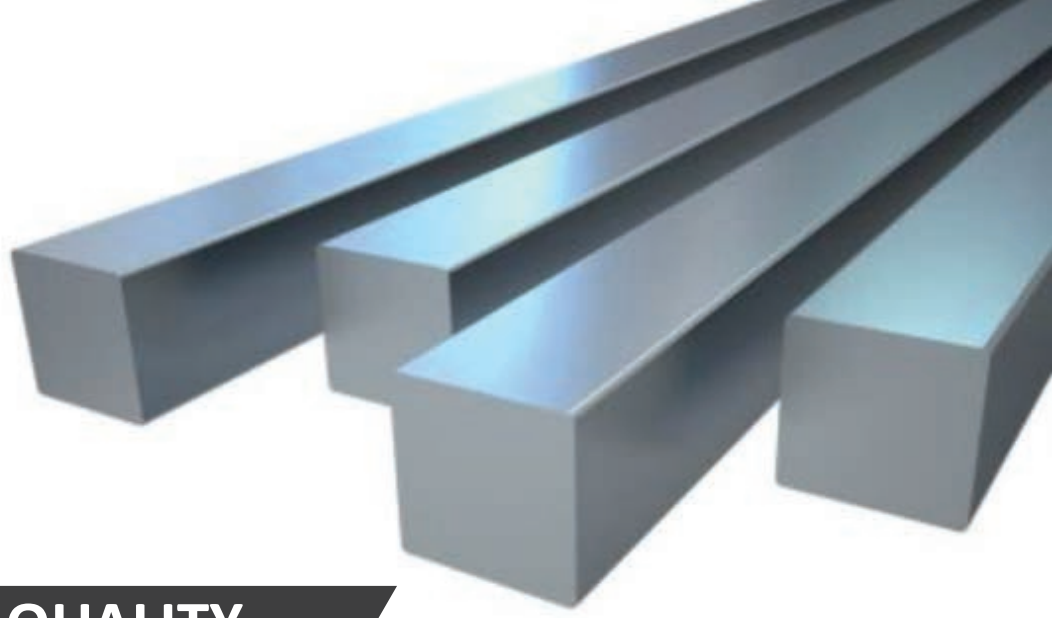

STANDARDS & QUALITY

EN 10059 – S235/S275/S355 JR-J0
ASTM –A36/A570/A615/A572/GR40/GR50/GR60



SIZE	WEIGHT kg/m
7x7	0,385
8x8	0,502
9x9	0,636
10x10	0,785
11x11	0,95
12x12	1,13
13x13	1,327
14x14	1,539
15x15	1,766
16x16	2,01
18x18	2,543
20x20	3,14
25x25	4,906

• Different sizes, qualities, standards and length available.

• Différentes tailles, qualités, normes et longueurs disponibles

مختلفة والجودة, حجام, والطول, والمعايير, المتاحة



FLAT BARS
Fer Plat
شريط مسطح

Smooth or Hammered

EN10058-S235/S275/S355 JR J0

ASTM-A36/A570/A615/A572/GR40/GR50/GR60

SIZE (mm)	SIZE (mm)	SIZE (mm)	THICK FLAT BARS SIZE
12x4	20x4	40x10	40x12
12x5	20x5	50x3	40x15
12x6	20x6	50x4	40x16
14x3	20x8	50x5	50x12
14x4	20x10	50x6	50x14
14x5	25x3	50x8	50x16
14x6	25x4	50x10	60x12
15x3	25x5	60x6	60x14
15x4	25x6	60x8	60x15
15x5	25x8	60x10	60x16
15x6	25x10	70x7	
16x3	30x3	70x8	
16x4	30x4	70x10	
16x5	30x5	80x6	
16x6	30x6	80x7	
16x8	30x8	80x8	
16x10	30x10	80x10	
18x3	40x3	80x12	
18x4	40x4	100x6	
18x6	40x5	100x8	
18x6	40x6	100x10	
20x3	40x8	100x12	

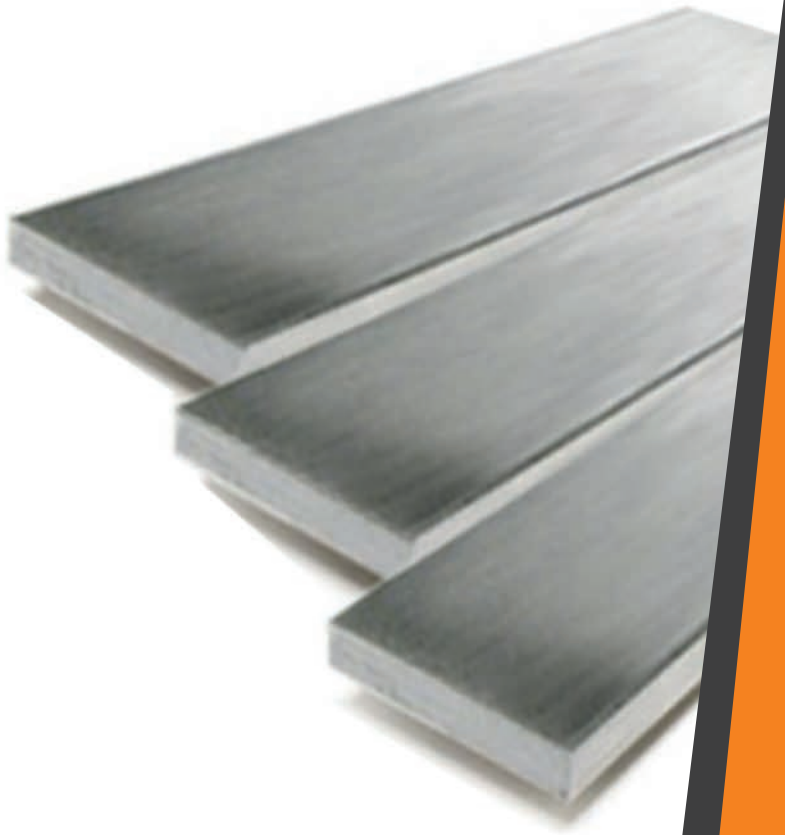

• Different sizes, qualities, standards and length available.

• Différentes tailles, qualités, normes et longueurs disponibles

مختلفة والجودة ,حجام,والطول,والمعايير,المتاحة

EQUAL ANGLES
Les Cornières
زاوية متساوية



STANDARDS & QUALITY

EN10056-S235/S275/S355JR-J0
ASTM-A36/A570/A615/A572/GR40/GR50/GR60



SIZE (mm)	WEIGHT kg/m
19x19x1,9	0,538
20x20x3	0,879
25x25x2,5	0,939
25x25x3	1,114
25x25x4	1,452
30x30x2,5	1,15
30x30x3	1,363
30x30x4	1,779
35x35x2,5	1,346
35x35x3	1,599
35x35x4	2,093
35x35x5	2,572
40x40x3	1,844
40x40x4	2,417
40x40x5	2,974
45x45x3	2,101
45x45x4	2,753
45x45x5	3,389
50x50x4	3,056
50x50x5	3,77
50x50x6	4,469
60x60x4	3,696
60x60x6	5,423

• Different sizes, qualities, standards and length available.

• Différentes tailles, qualités, normes et longueurs disponibles

مختلفة والجودة, حجام, والطول, والمعايير, المتاحة



ROUND BARS
Fer Rond
دائري قضبان

STANDARDS & QUALITY

EN 10060-S235/S275/S355JRJ0
ASTM-A36/A570/A615/A572/GR40/GR50/GR60
From 4,50 mm up to 40,00 mm

SIZE (mm)	WEIGHT kg/m
8	0,395
8,5	0,446
9	0,5
9,5	0,557
10	0,617
10,5	0,68
11	0,746
11,5	0,816
12	0,888
12,5	0,964
13	1,042
13,5	1,124
14	1,209
14,5	1,297
15	1,388
15,5	1,482
16	1,597
17	1,783
18	1,998
19	2,227
20	2,467
22	2,985
24	3,553
25	3,855



• Different sizes, qualities, standards and length available.

• Différentes tailles, qualités, normes et longueurs disponibles

مختلفة الجودة, حجام, والطول, والمعايير, المتاحة

UPN PROFILES

الملف

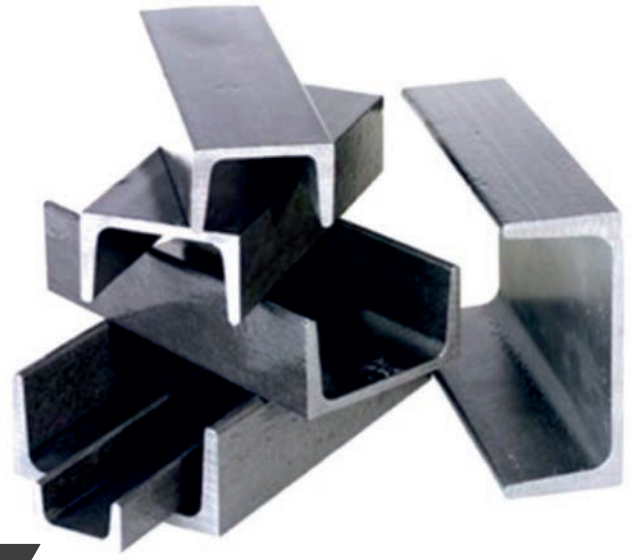

STANDARDS & QUALITY

EN10279-S235/S275/S355 JR-J0

ASTM-A36/A570/A615/A572/GR40/GR50/GR60



SIZE (mm)	WEIGHT kg/m
30x15x3	1,47
30x15x4	1,7
35x17,4x3	1,84
35x17,4x4	2,04
40x20x3	2,04
40x20x5	2,87
50x25x3	3
50x25x5	3,86
50x38x5	5,56
60x30x3,5	3,9
60x30x6	5
65x42x5,5	7,09
80x45x5,6	8,64
100x50x6	10,6
120x55x7	13,4
140x60x7	16
160x65x7,5	18,8
180x70x8	22
200x75x8,5	25,3

• Different sizes, qualities, standards and length available.

• Différentes tailles, qualités, normes et longueurs disponibles

مختلفة والجودة، حجام، والطول، والمعايير، المتاحة

IPN PROFILES

الملف

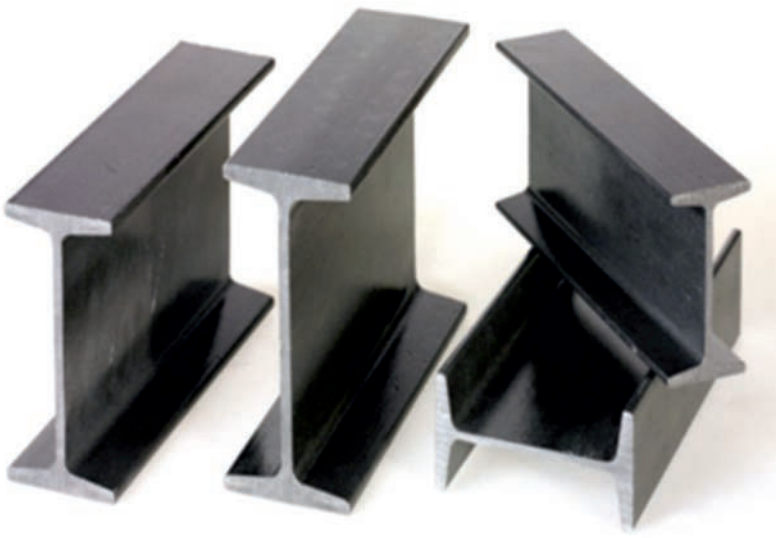

STANDARDS & QUALITY

EN10024-S235/S275/S355JR-J0

ASTM – A36/A570/A615/A572/GR40/GR50/GR60

SIZE (mm)	DIMENSION (mm)	WEIGHT (kg/m)
80	80x42x3,9	5,95
100	100x50x4,5	8,32
120	120x58x5,1	11,2
140	140x66x5,7	14,347
160	160x74x6,3	17,9
180	180x82x6,9	21,9
200	200x90x7,5	26,2

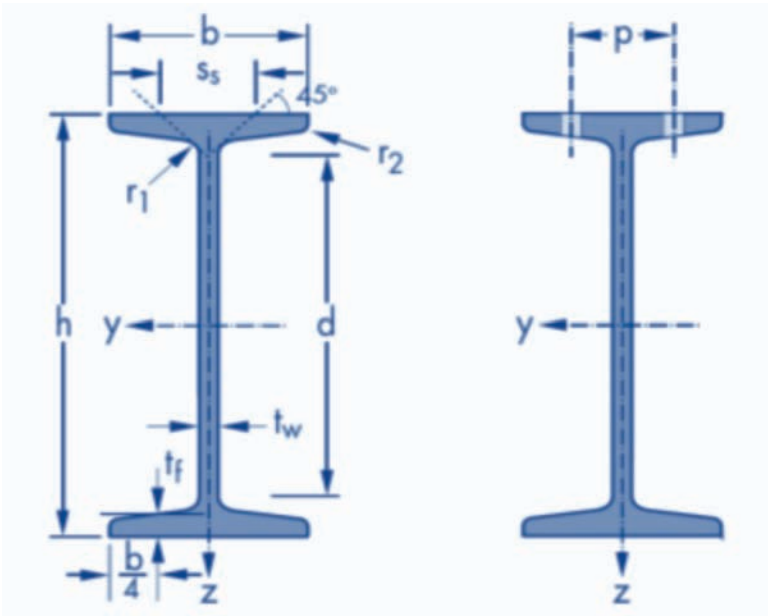

• Different sizes, qualities, standards and length available.

• Différentes tailles, qualités, normes et longueurs disponibles

مختلفة الجودة, حجام, والطول, والمعايير, المتاحة



IPE-A/IPE-AA/IPE-AAA/IPE-AAAA

STANDARDS & QUALITY

EN 10034-S235/S275/S355 JR-J0

ASTM-A36/A570/A615/A572/GR40/GR50/GR60

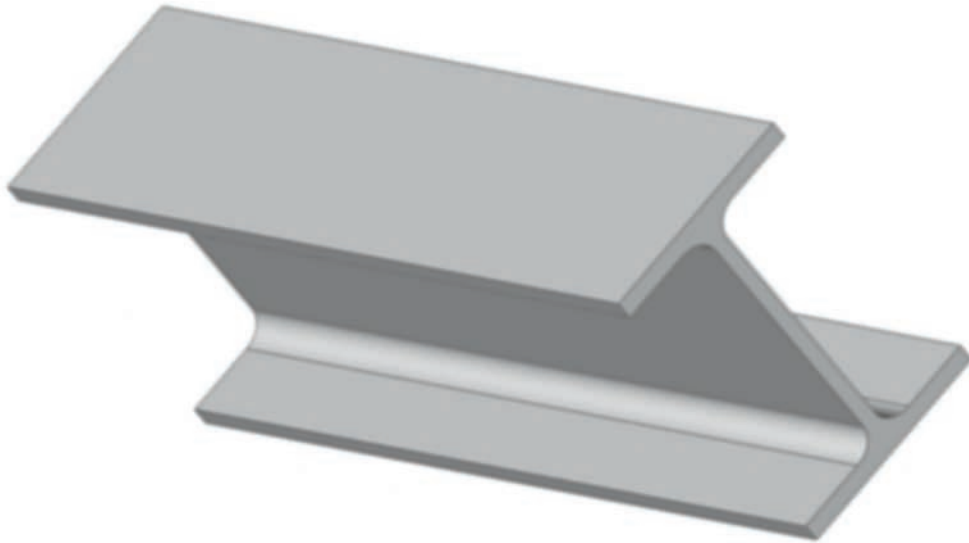

IPE-A/IPE-AA/IPE-AAA/IPE-AAAA

IPE-A			IPE-AA		IPE-AAA		IPE-AAAA	
SIZE (mm)	DIMENSION	WEIGHT	DIMENSION	WEIGHT	DIMENSION	WEIGHT	DIMENSION	WEIGHT
	(mm)	(kg/m)	(mm)	(kg/m)	(mm)	(kg/m)	(mm)	(kg/m)
80	78x46x3,3	5	78x46x3,2	4,9	78x46x3	4,75	78x46x2,5	3,92
100	98x55x3,6	6,9	97,6x55x3,6	6,7	97x55x3,5	6,6	97,6x55x2,8	5,39
120	117,6x64x3,8	8,7	117x64x3,8	8,4	117x64x3,3	8,3	117x64x3	6,92
140	137,4x73x3,8	10,5	136,6x73x3,8	10,1	136x73x3,2	8,8	136x73x3,2	8
160	157x82x4	12,7	156,4x82x4	12,1	156,4x82x3,7	1,95		

• Different sizes, qualities, standards and length available.

• Différentes tailles, qualités, normes et longueurs disponibles

مختلفة الجودة، حجم، والطول، والمعايير، المتاحة



REBAR
Fer a Beton
حديد التسليح

STANDARDS & QUALITY

TS 708/ ASTM A615 /BS4449/GOST 10884-94/DIN 488
NF A 35-016,S2738,NP 332,JS 33 ,CAN/CSA-G30,18-M92,ELOT 971
PLAIN AND DEFORMED

SIZE (mm)	WEIGHT (kg/mt)	WEIGHT (kg/12mt)
8mm	0,395	4,75
10mm	0,617	7,404
12mm	0,888	10,656
14mm	1,208	14,496
16mm	1,578	18,936
18mm	1,998	23,976
20mm	2,466	25,592
22mm	2,984	35,808
24mm	3,551	42,612
25mm	3,853	42,236
26mm	4,168	50,016
28mm	4,834	58,008
30mm	5,549	66,588
32mm	6,313	75,756
36mm	7,99	95,88
40mm	9,865	118,38



• Different sizes, qualities, standards and length available.

• Différentes tailles, qualités, normes et longueurs disponibles

مختلفة الجودة, حجام, والطول, والمعايير, المتاحة

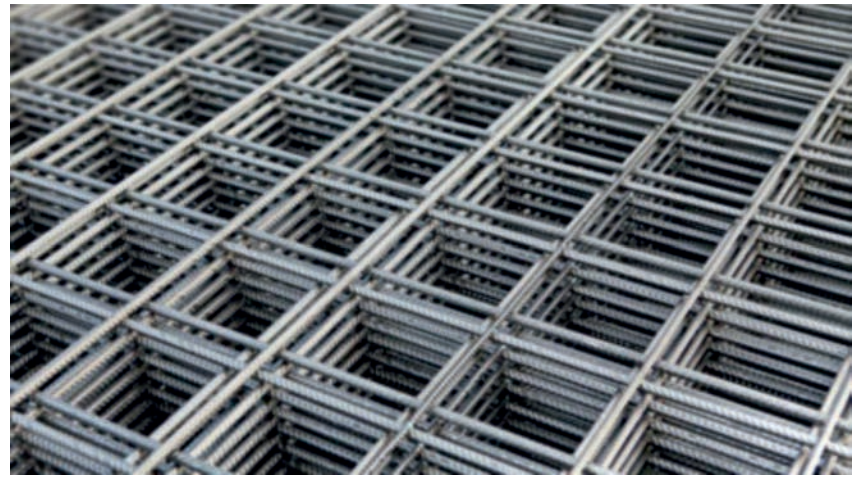

WIRE MESH Treillis Métal

STANDARDS & QUALITY

TS 708/ ASTM A615 /BS4449/GOST 10884-94/DIN 488
NF A 35-016,S2738,NP 332,JS 33 ,CAN/CSA-G30,18-M92,ELOT 971
PLAIN AND DEFORMED
From 4,00mm up to 40,00mm

SIZE (mm)	R	WEIGHT (kg)
4,50mm	R106	14.75
5,00mm	R131	18.17
5,50mm	R158	20.64
6,00mm	R188	23.27
6,50mm	R221	26.12
7,00mm	R257	29.27

SIZE (mm)	Q	WEIGHT (kg)
4,50mm	Q 106/106	17.98
5,00mm	Q131/131	22.15
5,50mm	Q158/158	26.89
6,00mm	Q188/188	31.92
6,50mm	Q221/221	37.39
7,00mm	Q257/257	43.43

• Different sizes, qualities, standards and length available.

• Différentes tailles, qualités, normes et longueurs disponibles

مختلفة والجودة ,حجام,والطول,والمعايير,المتاحة

WIRES

Fil d'attache
سلاك

GALVANIZED WIRE

SIZE (mm)

1,50mm
1,80mm
2,00mm
2,20mm
2,50mm
2,80mm
3,00mm
3,50mm
4,00mm



BLACK ANNEALED WIRE

SIZE (mm)

0,80mm
Binding wire
1,20mm
Binding wire
2,00mm
Binding wire
2,50mm
Reinforcing wire
3,00mm
Reinforcing wire
4,00mm
Reinforcing wire



BARBED WIRE



BALE WIRE

SIZE (mm)

1,70-3,50mm



• Different sizes, qualities, standards and length available.

• Différentes tailles, qualités, normes et longueurs disponibles

مختلفة والجودة ,حجم,والطول,والمعايير,المتاحة

NAILS
Clou Acier
مسامير



-Construction Nails

-Machine Quality Nails

-Epal Nails

-Wire Collated Nails

-Jumbo Winding Nails

-Wire Nails

-Joit Hanger Nails

-High Carbon Nails

PACKING:5KGS/10KGS/25KGS

SIZE (mm)	
	kg/m
5mm	250x50
6mm	280x60
7mm	310x70
8mm	340x80
10mm	400x100
12mm	440x120
15mm	450x150
18mm	600x180
20mm	600x200

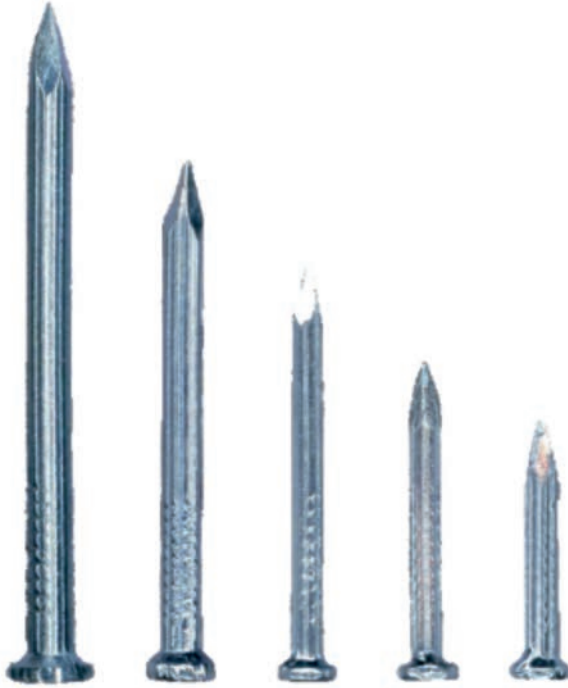

• Different sizes, qualities, standards and length available.

• Différentes tailles, qualités, normes et longueurs disponibles

مختلفة والجودة, حجام, والطول, والمعايير, المتاحة





HOLLOW SECTIONS

Les Tubes

القسم الخالي

ITEM CODE	STANDARDS	SIZE		THICKNESS		LENGHT		PRE GALV.	ANTI RUST	HAMMERED	FLOWER PRINTED
		MIN.	MAX	MIN.	MAX	MIN.	MAX				
	EN10305-5(TS EN10305-5)										
RECTANGLE PROFILE	EN10219(TS EN 10219)CE Marked	10x20mm	250x300mm	0,50mm	13,00mm	4 meter	14,6 meter	X	X	X	X
	DIN 2395, DIN59411, BS 6363										
	ASTM A500,SI 1458 TS 5317										
	EN10305-5(TS EN10305-5)										
SQUARE PROFILE	EN 10219(TS EN 10219)CE Marked	10X10mm	250x250mm	0,50mm	13,00mm	4 meter	14,6 meter	X	X	X	X
	DIN 2395,DIN59411,BS 6363										
	ASTM A 500,SI 1458 TS 5317										
	EN10305-5(TS EN10305-5)										
INDUSTRIAL PIPE	EN 10219(TS EN 10219)CE Marked	13,00mm	339,70mm	0,50mm	13,00mm	4 meter	14,6 meter	X	X	X	X
	DIN 2395, DIN59411, BS 6363										
	ASTM A 500,SI 1458 TS 5317										

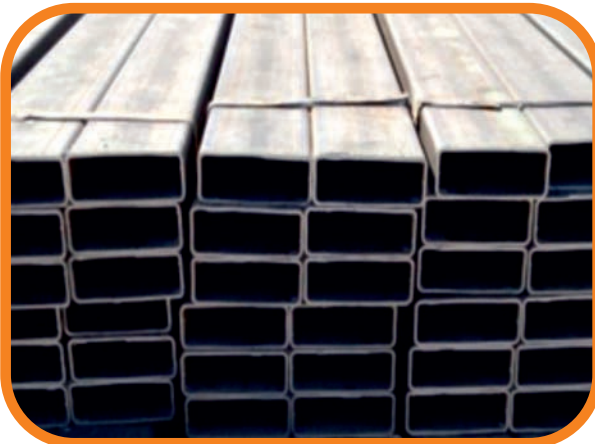

• Different sizes, qualities, standards and length available.

• Différentes tailles, qualités, normes et longueurs disponibles

مختلفة الجودة، حجام، والطول، والمعايير، المتاحة

PIPES
Les Tubes
أنابيب



STANDARDS & QUALITY

ITEM CODE	STANDARDS	SIZE		THICKNESS		LENGHT		HDG	THREAD CUTTING
		MIN.	MAX	MIN.	MAX	MIN.	MAX		
WATER	TS 301-1 /2/3/4,EN 10255(TS EN 10255) CE Marked								
&	EN 10224(TS 9341 EN10224),ASTM A 53,DIN 2440-2441	17,20 mm	339,70 mm	1,00 mm	13,00 mm	4 meter	14,6 meter	x	x
GAS PIPES	BS 1387,NFA 49-145 ISO 65(TS ISO65),UNI 8863,SI 103-530								
	SI4314,BS4360,ASTM A795,DIN1623,EN10217-1-2(TS EN 10217-1-2)								
	API 5 L PSL 1,API 5L PSL2, API 5L PSL 2(SOURCE SERVICE)								
NATURAL	API 5 L PSL 2(OFFSHORE SERVICE),TS 6047-1-EN 10208-1(EN10208-1)	21,3 mm	323,7 mm	2,00 mm	13,00 mm	4 meter	14,6 meter		x
GAS PIPES	TS 6047-2-EN 10208-2(EN 10208-2)								



• Different sizes, qualities, standards and length available.

• Différentes tailles, qualités, normes et longueurs disponibles

مختلفة والجودة ,حجام,والطول,والمعايير,المتاحة

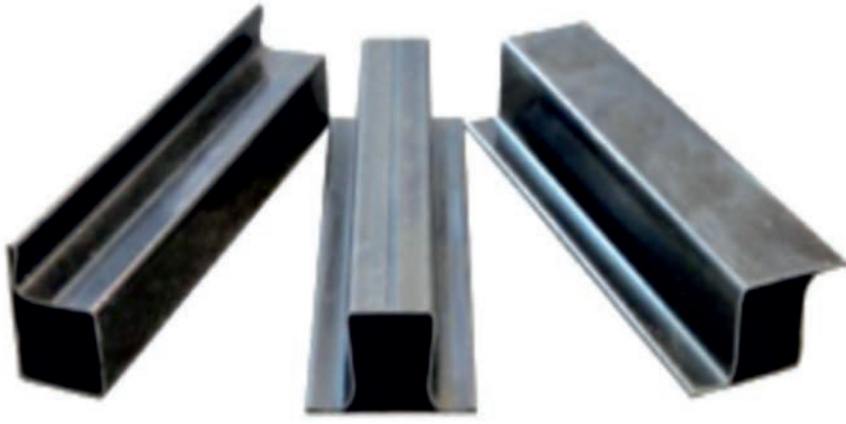

L-T-Z PROFILES

الملف LTZ

STANDARDS & QUALITY

ITEM CODE	STANDARDS	SIZE		THICKNESS		LENGHT	
		MIN.	MAX	MIN.	MAX	MIN.	MAX
L PROFILE	EN 10305-5(TS EN10305-5)	37,5X28 mm	45x33 mm	1,20 mm	1,50 mm	4 meters	12 meters
T PROFILE	EN 10305-5(TS EN10305-5)	50x28 mm	60x33 mm	1,20 mm	1,50 mm	4 meters	12 meters
Z PROFILE	EN 10305-5(TS EN10305-5)	50x28 mm	60x33 mm	1,20 mm	1,50 mm	4 meters	12 meters

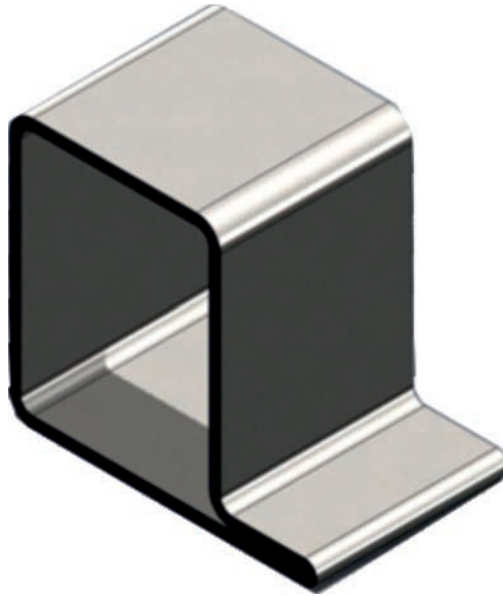

• Different sizes, qualities, standards and length available.

• Différentes tailles, qualités, normes et longueurs disponibles

مختلفة والجودة ,حجام,والطول,والمعاير,المتاحة

VEMIS

S T E E L

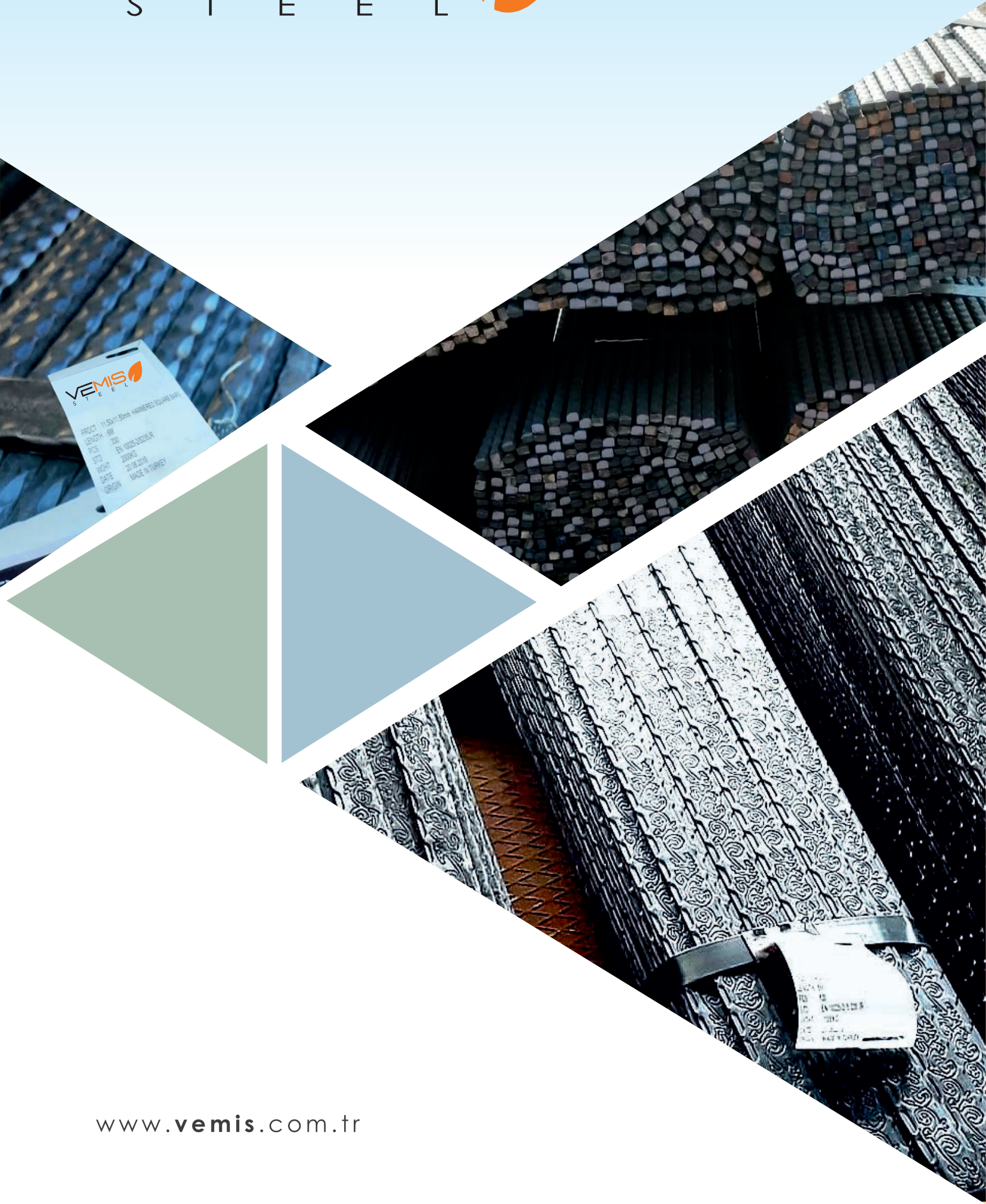

VEMIS
S T E E L

PROJ: 11.5011.00m - HANGIRI KURUMU
LENGTH: 6M
PCS: 330
STO: EN 10277:2012
WGT: 200KG
DATE: 21.08.2019
ORIGIN: MADE IN TURKEY

VEMIS
S T E E L

PROJ: 11.5011.00m - HANGIRI KURUMU
LENGTH: 6M
PCS: 330
STO: EN 10277:2012
WGT: 200KG
DATE: 21.08.2019
ORIGIN: MADE IN TURKEY



VEMIS 
S T E E L

www.vemis.com.tr



+90 532 207 92 17



+90 537 365 79 49



+90 326 614 61 96



+90 326 614 49 86



export@vemis.com.tr • vemis@vemis.com.tr



Savaş Mh. Şehit Pamir Cd. 4 Nolu Belediye İşh. No:40/19 - İskenderun / HATAY / TURKEY